

SAHA MICA CAPACITORS

Quick Reference Guide

DM Series General Specifications by Case Size

SAHA DESIGNATION		DM 05	DM 10	DM 12	DM 15
MIL STYLE - Discontinued		-	CM 04	-	CM 05
CAPACITANCE RANGE pF		1 to 390	1 to 390	1 to 2500	1 to 1200
MAXIMUM CAPACITANCE	50 V DC	390	820	-	2500
IN pF IN THE RATED VOLTAGE	100 V DC	200	390	2500	2000
	300 V DC	120	360	820	2000
	500 V DC	-	250	430	750
	1000 V DC*	-	-	-	330 - 430
INDICATED					
MAXIMUM NOMINAL DIMENSIONS IN INCHES	L	0.270	0.390	0.413	0.490
	W	0.250	0.380	0.433	0.420
	T	0.190	0.220	0.220	0.240
	B	0.120	0.141	0.200	0.234
MAXIMUM NOMINAL DIMENSIONS IN mm	L	6.86	9.91	10.49	12.45
	W	6.35	9.65	11.00	10.67
	T	4.83	5.59	5.59	6.10
	B	3.05	3.58	5.08	5.94

SAHA DESIGNATION		DM 19	DM 20	DM 30	DM 42
MIL STYLE - Discontinued		CM 06	-	CM 07	-
CAPACITANCE RANGE pF		1 to 8200	680 to 12,000	5100 to 20,000	16000 to 82000
MAXIMUM CAPACITANCE	50 V DC	-	-	-	-
IN pF IN THE RATED VOLTAGE	100 V DC	8200	12000	-	82000
	300 V DC	6800	12000	20000	68000
	500 V DC	5100	10000	20000	51000
	1000 V DC*	4700	-	12000	30000
INDICATED					
MAXIMUM NOMINAL DIMENSIONS IN INCHES	L	0.710	0.820	0.830	1.470
	W	0.590	0.630	0.920	0.920
	T	0.370	0.450	0.450	0.450
	B	0.344	0.438	0.438	1.063
MAXIMUM NOMINAL DIMENSIONS IN mm	L	18.03	20.83	21.08	37.34
	W	14.99	16.00	23.37	23.37
	T	9.40	11.43	11.43	11.43
	B	8.74	11.13	11.13	27.00

* Available as special part.

M Series

General Specifications

(Formerly Sold as

RS Components 124-XXX series)

SAHA Designation	M - 6	M - 12
Capacitance Range in pF	22 - 68	82 - 220
Maximum Capacitance in the rated voltage 350 VDC	68	220

SAHA Designation	M - 37	M - 50
Capacitance Range in pF	270 - 560	680 - 10000
Maximum Capacitance in the rated voltage 350 VDC	560	10000

MMR & MMA Series General Specifications

MMR Series (Equivalent to: ASHCROFT (GB) and JAHRE (D) Molded Radial)

SAHA Designation	MMR B - 1	MMR B - 2	MMR L - 1	MMR E - 1	MMR E - 2
Capacitance Range (pF)	4 - 1,500	750 - 2,500	4 - 1,500	4 - 6,000	4,001 - 10,000
Maximum Capacitance in the rated voltage	100 V DC 350 V DC 750 V DC	1,500 1,500 -	1,500 750 -	6,000 4,000 -	10,000 7,500 -

SAHA Designation	MMR A - 1	MMR A - 2	MMR A - 3	MMR A - 4	MMR S - 1
Capacitance Range (pF)	4 - 7,500	4 - 15,000	2,001 - 27,000	3,501 - 40,000	4 - 60,000
Maximum Capacitance in the rated voltage	100 V DC 350 V DC 750 V DC	7,500 5,000 1,000	15,000 10,000 2,000	27,000 15,000 3,500	40,000 20,000 5,000

MMA Series (Equivalent to: ASHCROFT (GB) and JAHRE (D) Molded Axial)

SAHA Designation	MMA 10	MMA 15	MMA 20	MMA 30	
Capacitance Range (pF)	10 - 5,100	10 - 1,000	10 - 2,700	560 - 43,000	
Maximum Capacitance in the rated voltage	300 V DC 500 V DC	5,100 380	- 1,000	- 2,700	43,000 30,000

MICA CAPACITOR - PART NUMBERING SYSTEM

Sample Part Number: DM05FA151J-CA Description: DM05 Series, 150pF, 100 Volt, 5% in Ammo Pack, Inside Crimped.



Series

Enter Series Code: (up to 4 Characters)

Series included: DM05, DM10, DM12, DM15, DM19, DM20, DM30, DM42.

Characteristic

Enter characteristic code: (1 Character)

Characteristic Letter	Temperature Coefficient PPM/C	Capacitance Drift
C	-200 to +200	±(0.5% + 0.1pF)
D	-100 to +100	±(0.3% + 0.1pF)
E	-20 to +100	±(0.1% + 0.1pF)
F	0 to +70	±(0.05% + 0.1pF)

see catalog for individual part characteristic code

Rated Voltage

Enter voltage code: (1 character)

Rated Voltage Code	Volts DCW
Y	50
A	100
C	300

Rated Voltage Code	Volts DCW
E	350
D	500
F*	1000*

* Note: Not for use in snubber applications

Capacitance

Enter EIA Capacitance Code: (3 Digits)

First Two Digits represents significant figures of capacitance in Picofarads.

Third Digit indicates number of zeros to follow.

Example: 10pF = 100, 100pF = 101, 1000pF = 102

Tolerance

Enter Capacitance Tolerance Code: (1 Character)

Tolerance Code

D	±0.5pF	H	±3 %
E	±0.5 %	J	±5 %
F	±1 %	K	±10 %
G	±2 %		

Temperature Range

Code O = -55 to +125 C

Vibration Grade

Standard Grade = 3

(see catalog for details)

Marking

S = Saha

Package Type

Bulk	< Blank >
Ammo Pack	A
Tape & Reel	T

Special Specifications

C	Cut	followed by 2 Digit specification code 01 -99	
R	Crimped	followed by 2 Digit specification code 01 -99	
P	Cut & Crimped	followed by 2 Digit specification code 01 -99	

Examples: C 0 2 = cut leads to 0.175 mm P 0 2 = cut leads to 0.175 mm and inside crimp

(See Special Specifications Sheet)

Rev D - 2/99

Part Marking

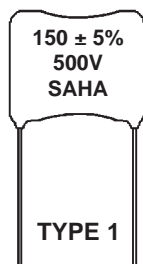

TYPE 1- Capacitance in pF, tolerance in percentage or +/- pF and voltage(Vdc) are indicated in numbers along with the brand marking. Brand marking of "SAHA", "S" or "KEC" are common. Parts are also supplied with no brand marking in some cases based on product availability and customer requirements.

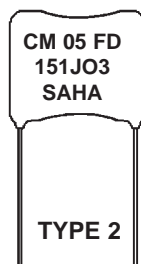

TYPE 2 - Formerly for Military certified Capacitors. The CM series code has been discontinued.

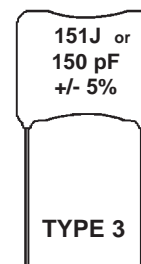

TYPE 3 - Capacitance in EIA capacitance code (as in Type 2) and tolerance with tolerance code or capacitance value in pF with tolerance in +/- % or +/- pF are marked on the capacitors. Voltage is not marked on the part. Brand marking is optional.

PERFORMANCE CHARACTERISTICS

GENERAL SPECIFICATIONS FOR SAHA MICA CAPACITORS

The SAHA Mica capacitors meet the required commercial specifications and the EIA requirements. The CMO series capacitors also meet the military specifications MIL-C-5. The actual specifications and dimensions of the capacitors are mentioned under each series in the catalog.

CAPACITANCE

The capacitance of mica capacitors is measured at 1 M Hz $\pm 10\%$ for capacitance values up to 1000 pF and at 1 K Hz $\pm 10\%$ for capacitance values above 1000 pF. The capacitance value when measured at 25 °C shall be within the tolerance specified.

DISSIPATION FACTOR

The dissipation factor for mica capacitors are measured at 1MHz for values up to 1000 pF and at 1 KHz for values above 1000 pF. The values shall remain within the specified values. The variation pattern of dissipation factor for different values of capacitance are also shown in the Figure 3.

INSULATION RESISTANCE

The insulation resistance is measured at 50 ± 5 V for capacitors with rated voltage of 50 V DC and at 100 ± 10 V for capacitors with higher voltage rating. The insulation resistance thus measured at 25 °C shall meet the specified limits. The variation of insulation resistance for different capacitance values at 25 °C is shown in Figure 1. After certain tests listed below the insulation resistance value changes and these values are plotted in Figure 2. Figure 4 indicates the variation pattern of insulation resistance with capacitance value at different temperature conditions.

WITHSTANDING VOLTAGE

The mica capacitors are designed to withstand higher voltage than the rated voltage for limited time. These capacitors shall withstand 200% of the rated voltage for 1 to 5 seconds when applied with a limiting surge current value of 50 mA.

VIBRATION GRADE

The capacitors shall be subjected to a harmonic motion having an amplitude of 1.5 mm and the frequency which is varied between the limits of 10 and 55 Hz. The entire frequency range from 10 to 55 Hz and then back to 10 Hz shall be traversed in approximately 1 minute and the motion shall be applied for a period of 1hour in each of the three mutually perpendicular directions. After testing, when the electrical measurements are performed:

1. The insulation resistance shall be more than 30000 M Ohms for capacitance value up to 10000 pF. Please refer to Figure 2 for acceptable variation pattern for Insulation Resistance for values above 10000 pF.
2. The dissipation factor shall be within the original specified limits. Please also refer to Figure 3 for variation pattern of dissipation factor with respect to capacitance value.
3. The capacitance change shall not exceed $\pm 1\%$ or ± 1 pF whichever is greater.

SOLDERING HEAT RESISTANCE

Both leads of the capacitors shall be immersed in molten solder at a temperature of 270 °C for 3 to 4 seconds. After the test the capacitors shall meet the initial requirements of the Withstanding voltage and the Capacitance change shall not exceed ± 0.55 or ± 1 pF.

MOISTURE RESISTANCE

Capacitors shall be subjected to a temperature of 40 ± 2 °C at 90 to 95 % relative humidity for 240 ± 8 Hours. After the test:

1. The samples shall meet the after test requirement of Insulation resistance values as furnished in Figure 2.
2. The dissipation factor shall be within 1.5 times the original specified limits. Please also refer to Figure 3 for variation pattern of dissipation factor with respect to capacitance value for original limits.
3. The capacitance change shall not exceed $\pm 3\%$ or ± 1 pF whichever is greater.

MOISTURE RESISTANCE LOADING

Capacitors shall be subjected to a temperature of 40 ± 2 °C at 90 to 95% relative humidity with rated voltage for 500 Hours. After the test the samples are maintained at normal temperature and relative humidity for a period of 4 to 24 hours. When tested after this;

1. The capacitor samples shall be free of cracks, or other mechanical damages and the marking shall remain legible
2. The samples shall meet the original requirement of the Withstanding voltage
3. The samples shall meet the after test requirement of Insulation resistance as furnished in Figure 2
4. The dissipation factor shall be within 2 times the original limits
5. The capacitance change shall not exceed $\pm 5\%$ or ± 1 pF

FIGURE 1

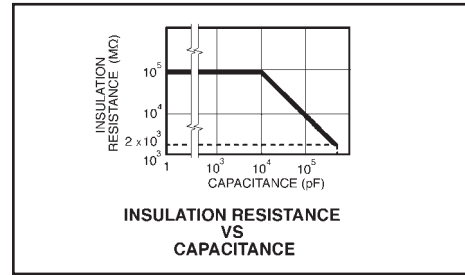

FIGURE 2

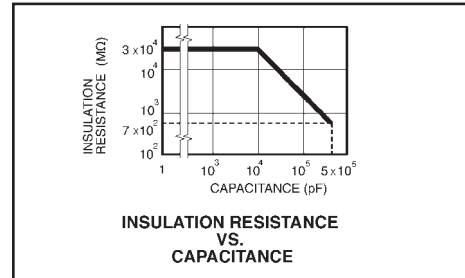

FIGURE 3

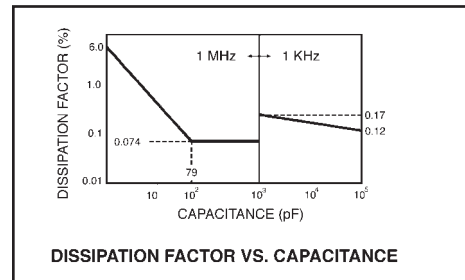

FIGURE 4

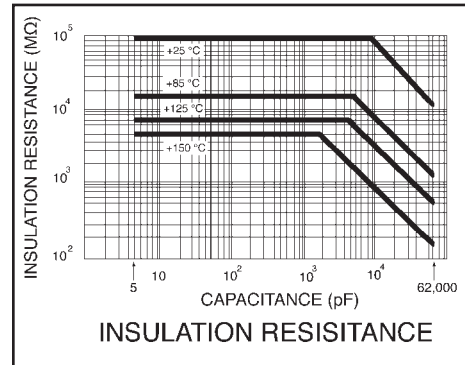
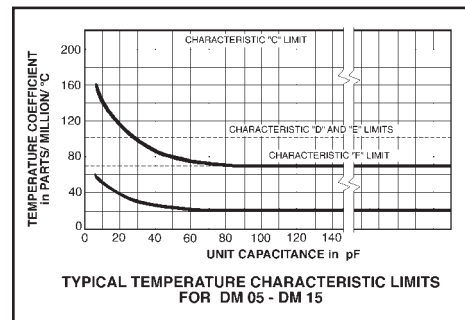

FIGURE 5



MOISTURE RESISTANCE LOADING

Capacitors shall be subjected to a temperature of 40 ± 2 °C at 90 to 95% relative humidity with rated voltage for 500 Hours. After the test the samples are maintained at normal temperature and relative humidity for a period of 4 to 24 hours. When tested after this;

1. The capacitor samples shall be free of cracks, or other mechanical damages and the marking shall remain legible
2. The samples shall meet the original requirement of the Withstanding voltage
3. The samples shall meet the after test requirement of Insulation resistance as furnished in Figure 2
4. The dissipation factor shall be within 2 times the original limits
5. The capacitance change shall not exceed $\pm 5\%$ or ± 1 pF

LIFE TEST

The capacitor samples shall be subjected to a temperature of 125 °C with 150% of rated voltage for 2000 hours.

After the test :

1. The capacitor samples shall be free of cracks, or other mechanical damages and the marking shall remain legible
2. The samples shall meet the original requirement of the Withstanding voltage
3. The samples shall meet the original requirements of Insulation resistance as furnished in Figure 1.
4. The dissipation factor shall be within 1.5 times the original limits
5. The capacitance change shall not exceed $\pm 3\%$ or ± 1 pF (whichever is greater) for characteristic "C" and $\pm 2.5 \pm 1$ pF (whichever is greater) for characteristic D, E and F.)

OTHER TYPICAL VARIATION PATTERNS

Some typical variation patterns for selected values during heat resistance load life test and moisture proof load life tests as listed below are illustrated in Figures 8 through 10.

1. Insulation resistance Vs. time for heat resistance load life test and moisture proof load life tests (Figure 8).
2. Capacitance change in percentage Vs. time (Figure 9).
3. Dissipation factor Vs. time (Figure 10).

Other variation patterns and characteristic for selected values as listed below are furnished as Figures 11 through 14

1. Capacitance change Vs. frequency (Figure 11)
2. Capacitance change Vs. time (Figure 12)
3. Dissipation factor change Vs. frequency (Figure 13)
4. Insulation resistance Vs. temperature (Figure 14)

FIGURE 6

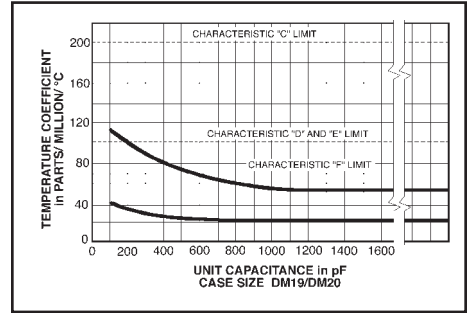

FIGURE 7

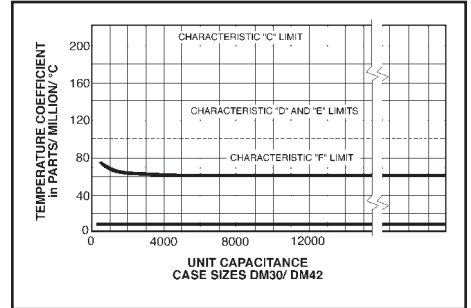

FIGURE 8

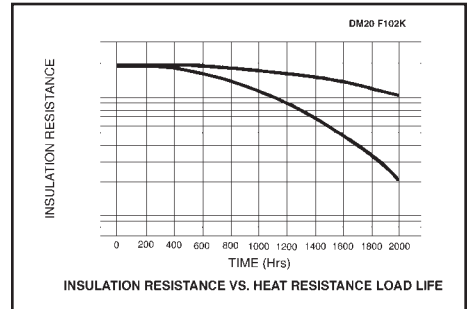

FIGURE 9

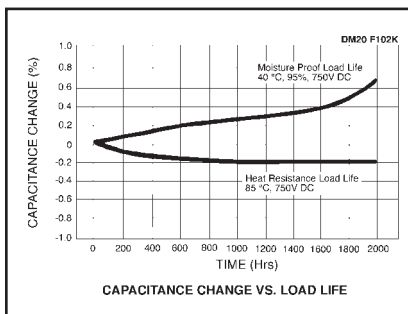

FIGURE 10

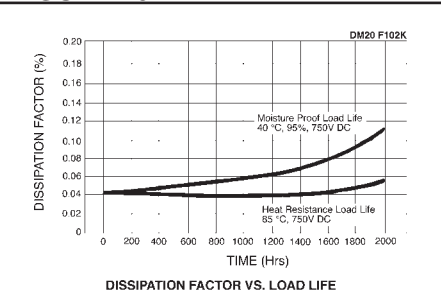

FIGURE 11

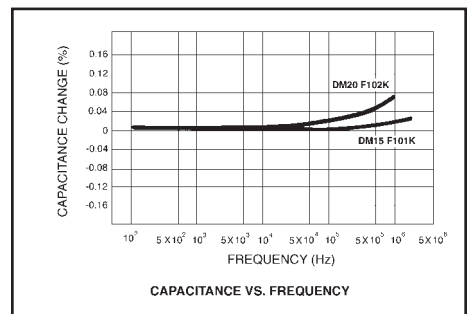

FIGURE 12

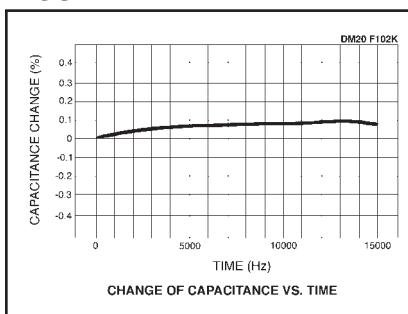

FIGURE 13

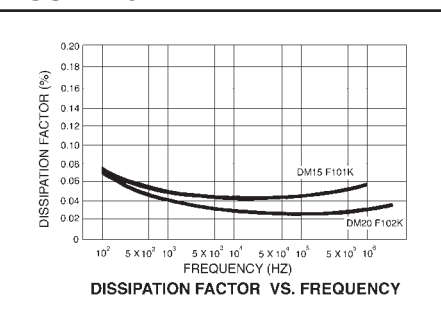
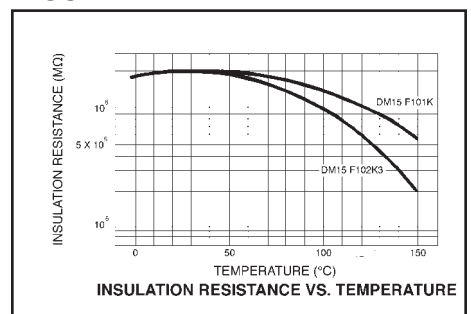

FIGURE 14



DM SERIES

INTRODUCTION

SAHA Mica capacitors have been designed to meet the exacting physical, electrical and environmental requirements of the MIL-C-5 and RS-153 specifications. Careful selection of raw materials, starting with the finest available grade of India Ruby Mica, and the constant monitoring of all equipment and processes, provides an overall uniform level of quality consistent with today's most sophisticated electronic equipment. Ideal for Tuning, Timing, Filtering and Coupling Circuits.

FEATURES

- Low loss and high stability
- Available in very close tolerances
- Suitable for precision applications
- Wide range of operating temperature

GENERAL SPECIFICATIONS

CAPACITANCE RANGE: 1 pF to 82,000 pF **VOLTAGE RATING:** 50 V DC to 500 V DC (Higher voltage capacitors can also be custom made) **TEMPERATE RATING:** - 40 to + 150 °C **CASE SIZES:** DM 05 to DM 42 **INSULATION RESISTANCE:** 100,000 M Ohms minimum at 25°C for capacitance up to 10,000 pF. Please refer to characteristic curve for values above the range. **DISSIPATION FACTOR** <0.1% at 1 M Hz for values between 100 to 1,000 pF <0.2 at 1K Hz for values above 1,000 pF. Please refer to characteristic curve for values above the range.

LIFE TEST DETAILS:

Capacitors shall withstand 1.5 times the rated DC voltage at 125 °C for 2000 hours. After the test:

1. Capacitance change shall not exceed 1% of the initial value or 1 pF, which ever is greater.
2. Dissipation Factor shall be within 1.5 times the original limits.
3. Insulation Resistance shall meet the initial specified requirements.
4. There shall be no remarkable change in the appearance and the marking shall remain legible.

CASE SIZE Vs. CAPACITANCE RANGE

Case Size	Capacitance Range in pF		Equivalent MIL Series
	Standard	MIL	
DM05	1 to 390	-	None
DM10	1 to 820	1 to 390	CM 04
DM12	1 to 2,500	-	None
DM15	1 to 2,500	1 to 390	CM 05
DM19	100 to 8,200	430 to 4,700	CM 06
DM20	680 to 12,000	-	None
DM30	5,100 to 20,000	5,100 to 20,000	CM 07
DM42	16,000 to 82,000	-	None

LEAD DIMENSIONS IN MILLIMETERS

Dimension	CASE CODE							
	DM05	DM10	DM12	DM15	DM19	DM20	DM30	DM42
B	3.05 ± 0.8	3.57 ± 0.8	5.00 ± 0.8	5.95 ± 0.8	8.73 ± 0.8	11.11 ± 0.8	11.11 ± 0.8	26.99 ± 0.8
C	0.40	0.40	0.50	0.60	0.80	0.80	1.00	1.00

LL" = 30 mm min.

Dimension "R" = 2.0 mm max. for DM 05 TO DM 15 and 3.2 mm max. for DM 19 to DM 42

LEAD DIMENSIONS IN INCHES

Dimension	CASE CODE							
	DM05	DM10	DM12	DM15	DM19	DM20	DM30	DM42
B	0.120 ± 0.031	0.141 ± 0.031	0.197 ± 0.031	0.234 ± 0.031	0.344 ± 0.031	0.438 ± 0.031	0.438 ± 0.031	1.063 ± 0.031
C	0.016 #26	0.016 #26	0.020 #24	0.025 #22	0.032 #20	0.032 #20	0.04 #18	0.04 #18

LL" = 1.25" min.

Dimension "R" = 0.078" max. for DM 05 TO DM 15 and 0.125"max. for DM 19 to DM 42

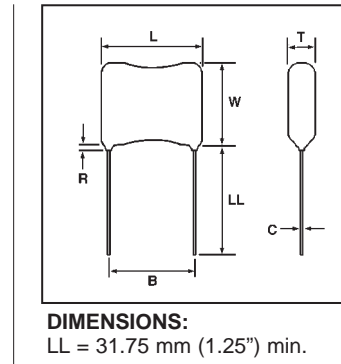

DM 05 Mica Capacitors

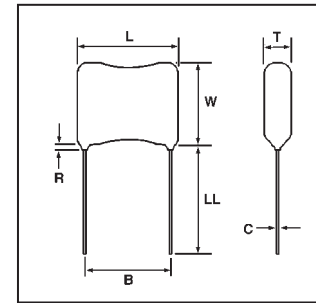

DIMENSIONS:
LL = 31.75 mm (1.25") min.

DM05
Case
Dimensions
in Millimeters
Lead Spacing:
3.05 ± 0.8mm

CAPACITANCE VALUE in pF	Characteristics	VOLTAGE								
		300 V DC			100 V DC			50 V DC		
		Lmax.	W max.	T max.	Lmax.	W max.	T max.	Lmax.	W max.	T max.
1 - 12	C	6.86	4.83	2.79						
15	C	6.86	4.83	3.05						
18 - 20	C	6.86	5.08	3.05						
22 - 24	C	6.86	5.08	3.05	6.86	4.83	3.05			
27	E	6.86	5.08	3.30	6.86	4.83	3.05			
30 - 33	E	6.86	5.08	3.30	6.86	5.08	3.05			
36	E	6.86	5.33	3.30	6.86	5.08	3.05			
39	E	6.86	5.33	3.30	6.86	5.08	3.05	6.86	4.83	3.05
43	E	6.86	5.33	3.56	6.86	5.08	3.05	6.86	4.83	3.05
47-51	E	6.86	5.33	3.56	6.86	5.08	3.30	6.86	4.83	3.05
56	E	6.86	5.59	3.81	6.86	5.08	3.30	6.86	4.83	3.05
62	E	6.86	5.59	3.81	6.86	5.33	3.30	6.86	5.08	3.05
68	E	6.86	5.59	3.81	6.86	5.33	3.56	6.86	5.08	3.05
75 - 82	E	6.86	5.84	4.06	6.86	5.33	3.56	6.86	5.08	3.05
91	F	6.86	5.84	4.32	6.86	5.33	3.56	6.86	5.08	3.30
100 - 110	F	6.86	6.10	4.57	6.86	5.59	3.81	6.86	5.08	3.30
120	F	6.86	6.35	4.83	6.86	5.59	4.06	6.86	5.08	3.30
130	F				6.86	5.84	4.06	6.86	5.33	3.30
150	F				6.86	5.84	4.32	6.86	5.33	3.56
160	F				6.86	5.84	4.32	6.86	5.33	3.56
170 - 180	F				6.86	6.10	4.57	6.86	5.33	3.56
200	F				6.86	6.35	4.83	6.86	5.59	3.81
220	F							6.86	5.59	3.81
240	F							6.86	5.59	4.06
270	F							6.86	5.84	4.06
300	F							6.86	5.84	4.32
330 - 360	F							6.86	6.10	4.57
390	F							6.86	6.35	4.83

DM05
Case
Dimensions
in Inches
Lead Spacing:
0.120 ± 0.031"

CAPACITANCE VALUE in pF	Characteristics	VOLTAGE								
		300 V DC			100 V DC			50 V DC		
		Lmax.	W max.	T max.	Lmax.	W max.	T max.	Lmax.	W max.	T max.
1 - 12	C	0.270	0.190	0.110						
15	C	0.270	0.190	0.120						
18 - 20	C	0.270	0.200	0.120						
22 - 24	C	0.270	0.200	0.120	0.270	0.190	0.120			
27	E	0.270	0.200	0.130	0.270	0.190	0.120			
30 - 33	E	0.270	0.200	0.130	0.270	0.200	0.120			
36	E	0.270	0.210	0.130	0.270	0.200	0.120			
39	E	0.270	0.210	0.130	0.270	0.200	0.120	0.270	0.190	0.120
43	E	0.270	0.210	0.140	0.270	0.200	0.120	0.270	0.190	0.120
47-51	E	0.270	0.210	0.140	0.270	0.200	0.130	0.270	0.190	0.120
56	E	0.270	0.220	0.150	0.270	0.200	0.130	0.270	0.190	0.120
62	E	0.270	0.220	0.150	0.270	0.210	0.130	0.270	0.200	0.120
68	E	0.270	0.220	0.150	0.270	0.210	0.140	0.270	0.200	0.120
75 - 82	E	0.270	0.230	0.160	0.270	0.210	0.140	0.270	0.200	0.120
91	F	0.270	0.230	0.170	0.270	0.210	0.140	0.270	0.200	0.130
100 - 110	F	0.270	0.240	0.180	0.270	0.220	0.150	0.270	0.200	0.130
120	F	0.270	0.250	0.190	0.270	0.220	0.160	0.270	0.200	0.130
130	F				0.270	0.230	0.160	0.270	0.210	0.130
150	F				0.270	0.230	0.170	0.270	0.210	0.140
160	F				0.270	0.230	0.170	0.270	0.210	0.140
170 - 180	F				0.270	0.240	0.180	0.270	0.210	0.140
200	F				0.270	0.250	0.190	0.270	0.220	0.150
220	F							0.270	0.220	0.150
240	F							0.270	0.220	0.160
270	F							0.270	0.230	0.160
300	F							0.270	0.230	0.170
330 - 360	F							0.270	0.240	0.180
390	F							0.270	0.250	0.190

SCDM 05 Mica Capacitors

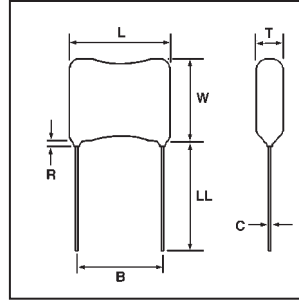

DIMENSIONS:
LL = 31.75 mm (1.25") min.

SCDM05

Case
Dimensions
in Millimeters

Lead Spacing:
3.05 ± 0.8mm

CAPACITANCE VALUE in pF	Characteristics	VOLTAGE								
		300 V DC			100 V DC			50 V DC		
		Lmax.	W max.	T max	Lmax.	W max.	T max	Lmax.	W max.	T max
1 - 12	C	6.35	4.06	2.29						
15 - 20	C	6.35	4.32	2.54	6.35	4.06	2.29			
22	C	6.35	4.32	2.54	6.35	4.06	2.54	6.35	4.06	2.29
24	C	6.35	4.32	2.54	6.35	4.32	2.54	6.35	4.06	2.29
27 - 36	E	6.35	4.32	2.79	6.35	4.32	2.54	6.35	4.06	2.29
39	E	6.35	4.57	2.79	6.35	4.32	2.54	6.35	4.06	2.29
43	E	6.35	4.57	3.05	6.35	4.32	2.54	6.35	4.32	2.54
47 - 51	E	6.35	4.57	3.05	6.35	4.32	2.79	6.35	4.32	2.54
56 - 62	E	6.35	4.57	3.30	6.35	4.32	2.79	6.35	4.32	2.54
68	E	6.35	4.83	3.30	6.35	4.57	2.79	6.35	4.32	2.54
75 - 82	E	6.35	4.83	3.56	6.35	4.57	3.05	6.35	4.32	2.54
91	F	6.35	4.83	3.81	6.35	4.57	3.05	6.35	4.32	2.79
100	F	6.35	5.08	4.06	6.35	4.57	3.30	6.35	4.32	2.79
110	F	6.35	5.08	4.06	6.35	4.83	3.30	6.35	4.32	2.79
120	F	6.35	5.33	4.32	6.35	4.83	3.56	6.35	4.32	2.79
130	F				6.35	4.83	3.56	6.35	4.32	2.79
150	F				6.35	4.83	3.81	6.35	4.57	3.05
160	F				6.35	5.08	3.81	6.35	4.57	3.05
170 - 180	F				6.35	5.08	4.06	6.35	4.57	3.05
200	F				6.35	5.33	4.32	6.35	4.57	3.30
220	F							6.35	4.83	3.30
240 - 270	F							6.35	4.83	3.56
300	F							6.35	4.83	3.81
330 - 360	F							6.35	5.08	4.06
390	F							6.35	5.33	4.32

SCDM05

Case
Dimensions
in Inches

Lead Spacing:
0.120 ± 0.031"

CAPACITANCE VALUE in pF	Characteristics	VOLTAGE								
		300 V DC			100 V DC			50 V DC		
		Lmax.	W max.	T max	Lmax.	W max.	T max	Lmax.	W max.	T max
1 - 12	C	0.250	0.160	0.090						
15 - 20	C	0.250	0.170	0.100	0.250	0.160	0.090			
22	C	0.250	0.170	0.100	0.250	0.160	0.100	0.250	0.160	0.090
24	C	0.250	0.170	0.100	0.250	0.170	0.100	0.250	0.160	0.090
27 - 36	E	0.250	0.170	0.110	0.250	0.170	0.100	0.250	0.160	0.090
39	E	0.250	0.180	0.110	0.250	0.170	0.100	0.250	0.160	0.090
43	E	0.250	0.180	0.120	0.250	0.170	0.100	0.250	0.170	0.100
47 - 51	E	0.250	0.180	0.120	0.250	0.170	0.110	0.250	0.170	0.100
56 - 62	E	0.250	0.180	0.130	0.250	0.170	0.110	0.250	0.170	0.100
68	E	0.250	0.190	0.130	0.250	0.180	0.110	0.250	0.170	0.100
75 - 82	E	0.250	0.190	0.140	0.250	0.180	0.120	0.250	0.170	0.100
91	F	0.250	0.190	0.150	0.250	0.180	0.120	0.250	0.170	0.110
100	F	0.250	0.200	0.160	0.250	0.180	0.130	0.250	0.170	0.110
110	F	0.250	0.200	0.160	0.250	0.190	0.130	0.250	0.170	0.110
120	F	0.250	0.210	0.170	0.250	0.190	0.140	0.250	0.170	0.110
130	F				0.250	0.190	0.140	0.250	0.170	0.110
150	F				0.250	0.190	0.150	0.250	0.180	0.120
160	F				0.250	0.200	0.150	0.250	0.180	0.120
170 - 180	F				0.250	0.200	0.160	0.250	0.180	0.120
200	F				0.250	0.210	0.170	0.250	0.180	0.130
220	F							0.250	0.190	0.130
240 - 270	F							0.250	0.190	0.140
300	F							0.250	0.190	0.150
330 - 360	F							0.250	0.200	0.160
390	F							0.250	0.210	0.170

Note: Bold Outlined Sections indicate SUSCO Standard items.

DM 10 / CM04 Mica Capacitors

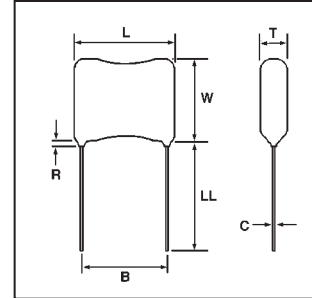

DIMENSIONS:
LL = 31.75 mm (1.25") min.

**DM10
CM04**
Case
Dimensions
in Millimeters

Lead Spacing:
3.57 ± 0.8mm

CAPACITANCE VALUE in pF	Characteristics	VOLTAGE								
		500 V DC			300 V DC			100 V DC		
		Lmax.	W max.	T max	Lmax.	W max.	T max	Lmax.	W max.	T max
1 - 18	C	9.14	8.38	4.83						
20 - 24	E	9.14	8.38	4.83						
27	E	9.40	8.38	4.83						
30 - 36	E	9.40	8.64	4.83						
39	E	9.40	8.64	4.83	9.40	8.64	4.83	9.14	8.38	4.83
43	E	9.40	8.64	4.83	9.40	8.64	4.83	9.40	8.38	4.83
47 - 68	E	9.40	8.64	4.83	9.40	8.64	4.83	9.40	8.64	4.83
75	E	9.40	8.64	5.08	9.40	8.64	4.83	9.40	8.64	4.83
82	E	9.40	8.89	5.08	9.40	8.64	4.83	9.40	8.64	4.83
91 - 100	F	9.40	8.89	5.08	9.40	8.89	5.08	9.40	8.64	4.83
110	F	9.65	8.89	5.08	9.40	8.89	5.08	9.40	8.64	4.83
120	F	9.65	8.89	5.08	9.40	8.89	5.08	9.40	8.64	5.08
130	F	9.65	9.14	5.08	9.65	8.89	5.08	9.40	8.89	5.08
150	F	9.65	9.14	5.33	9.65	8.89	5.08	9.40	8.89	5.08
160	F	9.65	9.14	5.33	9.65	9.14	5.08	9.40	8.89	5.08
180	F	9.91	9.40	5.33	9.65	9.14	5.33	9.65	8.89	5.08
200	F	9.91	9.40	5.59	9.65	9.14	5.33	9.65	8.89	5.08
220	F	9.91	9.40	5.59	9.91	9.40	5.33	9.65	9.14	5.33
240 - 250	F	9.91	9.65	5.59	9.91	9.40	5.59	9.65	9.14	5.33
270	F				9.91	9.65	5.59	9.65	9.40	5.33
300	F				9.91	9.65	5.59	9.91	9.40	5.33
330	F				10.16	9.91	5.84	9.91	9.40	5.59
360	F				10.16	9.91	5.84	9.91	9.65	5.59
390 - 400	F							9.91	9.65	5.59
430 - 680	F							10.16	9.91	5.84
750 - 820*	F							10.16	9.91	5.84

**DM10
CM04**
Case
Dimensions
in Inches

Lead Spacing:
0.141 ± 0.031"

CAPACITANCE VALUE in pF	Characteristics	VOLTAGE								
		500 V DC			300 V DC			100 V DC		
		Lmax.	W max.	T max	Lmax.	W max.	T max	Lmax.	W max.	T max
1 - 18	C	0.360	0.330	0.190						
20 - 24	E	0.360	0.330	0.190						
27	E	0.370	0.330	0.190						
30 - 36	E	0.370	0.340	0.190						
39	E	0.370	0.340	0.190	0.370	0.340	0.190	0.360	0.330	0.190
43	E	0.370	0.340	0.190	0.370	0.340	0.190	0.370	0.330	0.190
47 - 68	E	0.370	0.340	0.190	0.370	0.340	0.190	0.370	0.340	0.190
75	E	0.370	0.340	0.200	0.370	0.340	0.190	0.370	0.340	0.190
82	E	0.370	0.350	0.200	0.370	0.340	0.190	0.370	0.340	0.190
91 - 100	F	0.370	0.350	0.200	0.370	0.350	0.200	0.370	0.340	0.190
110	F	0.380	0.350	0.200	0.370	0.350	0.200	0.370	0.340	0.190
120	F	0.380	0.350	0.200	0.370	0.350	0.200	0.370	0.340	0.200
130	F	0.380	0.360	0.200	0.380	0.350	0.200	0.370	0.350	0.200
150	F	0.380	0.360	0.210	0.380	0.350	0.200	0.370	0.350	0.200
160	F	0.380	0.360	0.210	0.380	0.360	0.200	0.370	0.350	0.200
180	F	0.390	0.370	0.210	0.380	0.360	0.210	0.380	0.350	0.200
200	F	0.390	0.370	0.220	0.380	0.360	0.210	0.380	0.350	0.200
220	F	0.390	0.370	0.220	0.390	0.370	0.210	0.380	0.360	0.210
240 - 250	F	0.390	0.380	0.220	0.390	0.370	0.220	0.380	0.360	0.210
270	F				0.390	0.380	0.220	0.380	0.370	0.210
300	F				0.390	0.380	0.220	0.390	0.370	0.210
330	F				0.400	0.390	0.230	0.390	0.370	0.220
360	F				0.400	0.390	0.230	0.390	0.380	0.220
390 - 400	F							0.390	0.380	0.220
430 - 680	F							0.400	0.390	0.230
750 - 820*	F							0.400	0.390	0.230

* Available only in 50 V rating. Note: Values above 390 pF - available on special order only
Note: Bold Outlined Sections indicate SUSCO Standard items.

SCDM 10 Mica Capacitors

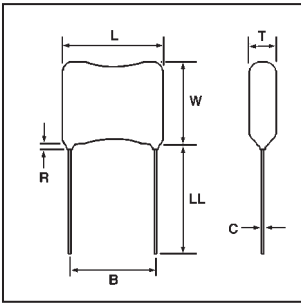

SCDM10

Case Dimensions in Millimeters

Lead Spacing: $3.57 \pm 0.8\text{mm}$

DIMENSIONS:
LL = 31.75 mm (1.25") min.

CAPACITANCE VALUE in pF	Characteristics	VOLTAGE								
		500 V DC			300 V DC			100 V DC		
		Lmax.	W max.	T max.	Lmax.	W max.	T max.	Lmax.	W max.	T max.
1 - 18	C	7.87	5.84	3.05						
20 - 56	E	7.87	5.84	3.05						
62 - 68	E	8.13	5.84	3.30	7.87	5.84	3.05			
75 - 82	E	8.13	5.84	3.30	8.13	5.84	3.30	7.87	5.84	3.05
91	F	8.13	5.84	3.30	8.13	5.84	3.30	7.87	5.84	3.05
100	F	8.13	5.84	3.30	8.13	5.84	3.30	8.13	5.84	3.30
110 - 120	F	8.13	6.10	3.56	8.13	5.84	3.30	8.13	5.84	3.30
130 - 160	F	8.13	6.10	3.56	8.13	6.10	3.56	8.13	5.84	3.30
180	F	8.38	6.10	3.81	8.13	6.10	3.56	8.13	6.10	3.56
200	F	8.38	6.10	3.81	8.38	6.10	3.81	8.13	6.10	3.56
220 - 240	F	8.64	6.35	4.06	8.38	6.10	3.81	8.13	6.10	3.56
250	F	8.64	6.35	4.06	8.64	6.35	4.06	8.13	6.10	3.56
270 - 300	F				8.64	6.35	4.06	8.38	6.10	3.81
330	F				8.89	6.60	4.32	8.38	6.10	3.81
360	F				8.89	6.60	4.32	8.64	6.35	4.06
390 - 400	F							8.64	6.35	4.06
430 - 470	F							8.89	6.60	4.32
750 - 820*	F							8.89	6.60	4.32

SCDM10

Case Dimensions in Inches

Lead Spacing: $0.141 \pm 0.031''$

* Available only in 50 V rating.
Note: Bold Outlined Sections indicate SUSCO Standard items.

CAPACITANCE VALUE in pF	Characteristics	VOLTAGE								
		500 V DC			300 V DC			100 V DC		
		Lmax.	W max.	T max.	Lmax.	W max.	T max.	Lmax.	W max.	T max.
1 - 18	C	0.310	0.230	0.120						
20 - 56	E	0.310	0.230	0.120						
62 - 68	E	0.320	0.230	0.130	0.310	0.230	0.120			
75 - 82	E	0.320	0.230	0.130	0.320	0.230	0.130	0.310	0.230	0.120
91	F	0.320	0.230	0.130	0.320	0.230	0.130	0.310	0.230	0.120
100	F	0.320	0.230	0.130	0.320	0.230	0.130	0.320	0.230	0.130
110 - 120	F	0.320	0.240	0.140	0.320	0.230	0.130	0.320	0.230	0.130
130 - 160	F	0.320	0.240	0.140	0.320	0.240	0.140	0.320	0.230	0.130
180	F	0.330	0.240	0.150	0.320	0.240	0.140	0.320	0.240	0.140
200	F	0.330	0.240	0.150	0.330	0.240	0.150	0.320	0.240	0.140
220 - 240	F	0.340	0.250	0.160	0.330	0.240	0.150	0.320	0.240	0.140
250	F	0.340	0.250	0.160	0.340	0.250	0.160	0.320	0.240	0.140
270 - 300	F				0.340	0.250	0.160	0.330	0.240	0.150
330	F				0.350	0.260	0.170	0.330	0.240	0.150
360	F				0.350	0.260	0.170	0.340	0.250	0.160
390 - 400	F							0.340	0.250	0.160
430 - 470	F							0.350	0.260	0.170
750 - 820*	F							0.350	0.260	0.170

DM 12 Mica Capacitors

DM12

Case Dimensions in Millimeters

Lead Spacing: $5.0 \pm 0.8\text{mm}$

CAPACITANCE VALUE in pF	Characteristics	VOLTAGE								
		500 V DC			300 V DC			100 V DC		
		Lmax.	W max.	T max.	Lmax.	W max.	T max.	Lmax.	W max.	T max.
1 - 18	C	9.50	10.01	4.50						
20 - 82	E	9.50	10.01	4.50						
91 - 430	F	9.50	10.01	4.50						
470	F	10.01	10.49	5.08						
510	F				10.01	10.49	5.08			
560	F				10.01	10.49	5.08			
620	F				10.01	10.49	5.08			
680	F				10.01	10.49	5.08			
750	F				10.49	11.00	5.59			
820	F				10.49	11.00	5.59			
910	F							10.49	11.00	5.59
1,000	F							10.49	11.00	5.59
1,100	F							11.00	11.51	6.10
1,200	F							11.00	11.51	6.10
1,300 - 2,500	F							11.00	11.51	6.10

DM12

Case Dimensions in Inches

Lead Spacing: 0.197 ± 0.031

Note: Bold Outlined Sections indicate SUSCO Standard items.

CAPACITANCE VALUE in pF	Characteristics	VOLTAGE								
		500 V DC			300 V DC			100 V DC		
		Lmax.	W max.	T max.	Lmax.	W max.	T max.	Lmax.	W max.	T max.
1 - 18	C	0.374	0.394	0.177						
20 - 82	E	0.374	0.394	0.177						
91 - 430	F	0.374	0.394	0.177						
470	F	0.394	0.413	0.200						
510	F				0.394	0.413	0.200			
560	F				0.394	0.413	0.200			
620	F				0.394	0.413	0.200			
680	F				0.394	0.413	0.200			
750	F				0.413	0.433	0.220			
820	F				0.413	0.433	0.220			
910	F							0.413	0.433	0.220
1,000	F							0.413	0.433	0.220
1,100	F							0.433	0.453	0.240
1,200	F							0.433	0.453	0.240
1,300 - 2,500	F							0.433	0.453	0.240

DM 15 / CM05 Mica Capacitors

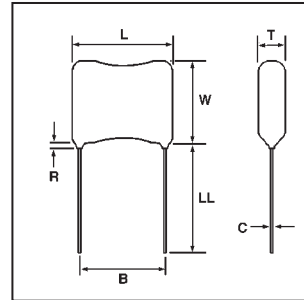

DIMENSIONS:
LL = 31.75 mm (1.25") min.

**DM15
CM05**
Case
Dimensions
in Millimeters

Lead Spacing:
5.95 ± 0.8mm

CAPACITANCE VALUE in pF	Characteristics	VOLTAGE								
		500 V DC			300 V DC			100 V DC		
		Lmax.	W max.	T max	Lmax.	W max.	T max	Lmax.	W max.	T max
1 - 18	C	11.43	9.14	4.32						
20 - 68	E	11.43	9.14	4.32						
75 - 82	E	11.43	9.14	4.57						
91 - 100	F	11.68	9.14	4.57						
110 - 130	F	11.68	9.40	4.57						
150 - 180	F	11.68	9.40	4.83						
200	F	11.68	9.65	4.83						
220 - 240	F	11.68	9.65	5.08						
270 - 390	F	11.94	9.91	5.33						
430	F	11.94	9.91	5.33	11.68	9.65	5.08			
470 - 510	F	11.94	10.16	5.59	11.68	9.65	5.08			
560 - 620	F	12.19	10.41	5.84	11.68	9.65	5.08			
680	F	12.45	10.67	6.10	11.94	9.91	5.33			
750	F	12.70	10.92	6.35	11.94	9.91	5.33			
820	F				11.94	9.91	5.33	11.94	9.91	5.33
910	F				11.94	10.16	5.59	11.94	10.16	5.59
1,000	F				12.19	10.16	5.84	12.19	10.16	5.84
1,100	F				12.45	10.67	6.10	12.19	10.16	5.84
1,200 - 2,000	F				12.70	10.92	6.35	12.45	10.67	6.10
2,200 - 2,500*	F							12.45	10.67	6.10

**DM15
CM05**
Case
Dimensions
in Inches

Lead Spacing:
0.234 ± 0.031

CAPACITANCE VALUE in pF	Characteristics	VOLTAGE								
		500 V DC			300 V DC			100 V DC		
		Lmax.	W max.	T max	Lmax.	W max.	T max	Lmax.	W max.	T max
1 - 18	C	0.450	0.360	0.170						
20 - 68	E	0.450	0.360	0.170						
75 - 82	E	0.450	0.360	0.180						
91 - 100	F	0.460	0.360	0.180						
110 - 130	F	0.460	0.370	0.180						
150 - 180	F	0.460	0.370	0.190						
200	F	0.460	0.380	0.190						
220 - 240	F	0.460	0.380	0.200						
270 - 390	F	0.470	0.390	0.210						
430	F	0.470	0.390	0.210	0.460	0.380	0.200			
470 - 510	F	0.470	0.400	0.220	0.460	0.380	0.200			
560 - 620	F	0.480	0.410	0.230	0.460	0.380	0.200			
680	F	0.490	0.420	0.240	0.470	0.390	0.210			
750	F	0.500	0.430	0.250	0.470	0.390	0.210			
820	F				0.470	0.390	0.210	0.470	0.390	0.210
910	F				0.470	0.400	0.220	0.470	0.400	0.220
1,000	F				0.480	0.400	0.230	0.480	0.400	0.230
1,100	F				0.490	0.420	0.240	0.480	0.400	0.230
1,200 - 2,000	F				0.500	0.430	0.250	0.490	0.420	0.240
2,200 - 2,500*	F							0.490	0.420	0.240

* Available only in 50 V rating.
Note: Bold Outlined Sections indicate SUSCO Standard items.

SCDM 15 Mica Capacitors

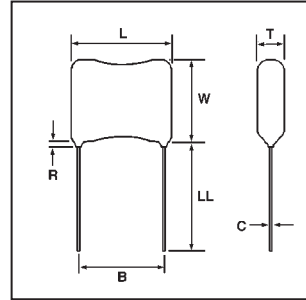

DIMENSIONS:
LL = 31.75 mm (1.25") min.

SCDM15
Case
Dimensions
in Millimeters

Lead Spacing:
5.95 ± 0.8mm

CAPACITANCE VALUE in pF	Characteristics	VOLTAGE								
		500 V DC			300 V DC			100 V DC		
		Lmax.	W max.	T max	Lmax.	W max.	T max	Lmax.	W max.	T max
1 - 18	C	10.92	7.11	3.56						
20 - 68	E	10.92	7.11	3.56						
75 - 100	F	10.92	7.11	3.81						
110 - 160	F	11.18	7.37	3.81						
180 - 200	F	11.18	7.37	4.06						
220 - 270	F	11.18	7.62	4.06						
300 - 390	F	11.43	7.87	4.06						
430 - 470	F	11.43	7.87	4.32	11.18	7.37	3.81			
510	F	11.43	7.87	4.57	11.18	7.37	3.81			
560	F	11.43	7.87	4.57	11.18	7.62	4.06			
620	F	11.43	8.13	4.83	11.18	7.62	4.06			
680	F	11.68	8.13	5.08	11.43	7.62	4.06			
750	F	11.68	8.13	5.33	11.43	7.62	4.06			
820	F				11.43	7.87	4.32	11.43	7.87	4.06
910	F				11.43	7.87	4.57	11.43	7.87	4.32
1,000	F				11.43	8.13	4.83	11.43	7.87	4.32
1,100	F				11.68	8.13	5.08	11.43	7.87	4.57
1,200 - 2,000	F				11.68	8.13	5.33	11.43	8.13	4.83
2,200 - 2,500*	F							11.43	8.13	4.83

SCDM15
Case
Dimensions
in Inches

Lead Spacing:
0.234 ± 0.031"

CAPACITANCE VALUE in pF	Characteristics	VOLTAGE								
		500 V DC			300 V DC			100 V DC		
		Lmax.	W max.	T max	Lmax.	W max.	T max	Lmax.	W max.	T max
1 - 18	C	0.430	0.280	0.140						
20 - 68	E	0.430	0.280	0.140						
75 - 100	F	0.430	0.280	0.150						
110 - 160	F	0.440	0.290	0.150						
180 - 200	F	0.440	0.290	0.160						
220 - 270	F	0.440	0.300	0.160						
300 - 390	F	0.450	0.310	0.160						
430 - 470	F	0.450	0.310	0.170	0.440	0.290	0.150			
510	F	0.450	0.310	0.180	0.440	0.290	0.150			
560	F	0.450	0.310	0.180	0.440	0.300	0.160			
620	F	0.450	0.320	0.190	0.440	0.300	0.160			
680	F	0.460	0.320	0.200	0.450	0.300	0.160			
750	F	0.460	0.320	0.210	0.450	0.300	0.160			
820	F				0.450	0.310	0.170	0.450	0.310	0.160
910	F				0.450	0.310	0.180	0.450	0.310	0.170
1,000	F				0.450	0.320	0.190	0.450	0.310	0.170
1,100	F				0.460	0.320	0.200	0.450	0.310	0.180
1,200 - 2,000	F				0.460	0.320	0.210	0.450	0.320	0.190
2,200 - 2,500*	F							0.450	0.320	0.190

* Available only in 50 V rating.
Note: Bold Outlined Sections indicate SUSCO Standard items.

DM 19 / CM06 Mica Capacitors

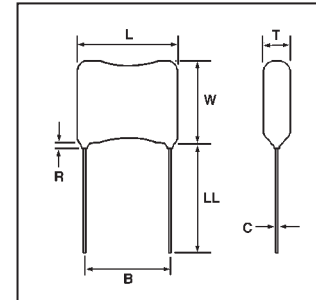

DIMENSIONS:
LL = 31.75 mm (1.25") min.

**DM19
CM06**
Case
Dimensions
in Millimeters

Lead Spacing:
8.73 ± 0.8mm

CAPACITANCE VALUE in pF	Characteristics	VOLTAGE								
		500 V DC			300 V DC			100 V DC		
		Lmax.	W max.	T max.	Lmax.	W max.	T max.	Lmax.	W max.	T max.
100 - 330	F	16.26	12.70	4.83						
360 - 470	F	16.26	12.95	5.08						
510 - 620	F	16.51	12.95	5.08						
680 - 910	F	16.51	12.95	5.33						
1,000 - 1,100	F	16.51	13.21	5.59						
1,200 - 1,300	F	16.76	13.21	5.59						
1,500	F	16.76	13.21	5.84						
1,600	F	16.76	13.46	5.84						
1,800 - 2,000	F	17.02	13.46	6.10						
2,200	F	17.02	13.46	6.35						
2,400	F	17.02	13.72	6.60						
2,700	F	17.27	13.72	6.86						
3,000	F	17.27	13.97	7.11						
3,300	F	17.27	13.97	7.37	17.02	13.72	6.60			
3,600	F	17.27	14.22	7.62	17.27	13.72	6.86			
3,900	F	17.53	14.22	7.87	17.27	13.72	6.86			
4,300	F	17.53	14.48	8.38	17.27	13.97	7.11			
4,700	F	17.78	14.73	8.89	17.27	13.97	7.37			
5,100	F	18.03	14.99	9.40	-	-	-			
5,600	F				17.27	14.22	7.87			
6,200	F				17.53	14.22	8.13	17.53	14.22	7.87
6,800	F				17.53	14.48	8.38	17.53	14.48	8.13
7,500	F							17.78	14.48	8.64
8,200	F							17.78	14.73	8.89

**DM19
CM06**
Case
Dimensions
in Inches

Lead Spacing:
0.344 ± 0.031"

CAPACITANCE VALUE in pF	Characteristics	VOLTAGE								
		500 V DC			300 V DC			100 V DC		
		Lmax.	W max.	T max.	Lmax.	W max.	T max.	Lmax.	W max.	T max.
100 - 330	F	0.640	0.500	0.190						
360 - 470	F	0.640	0.510	0.200						
510 - 620	F	0.650	0.510	0.200						
680 - 910	F	0.650	0.510	0.210						
1,000 - 1,100	F	0.650	0.520	0.220						
1,200 - 1,300	F	0.660	0.520	0.220						
1,500	F	0.660	0.520	0.230						
1,600	F	0.660	0.530	0.230						
1,800 - 2,000	F	0.670	0.530	0.240						
2,200	F	0.670	0.530	0.250						
2,400	F	0.670	0.540	0.260						
2,700	F	0.680	0.540	0.270						
3,000	F	0.680	0.550	0.280						
3,300	F	0.680	0.550	0.290	0.670	0.540	0.260			
3,600	F	0.680	0.560	0.300	0.680	0.540	0.270			
3,900	F	0.690	0.560	0.310	0.680	0.540	0.270			
4,300	F	0.690	0.570	0.330	0.680	0.550	0.280			
4,700	F	0.700	0.580	0.350	0.680	0.550	0.290			
5,100	F	0.710	0.590	0.370	-	-	-			
5,600	F				0.680	0.560	0.310			
6,200	F				0.690	0.560	0.320	0.690	0.560	0.310
6,800	F				0.690	0.570	0.330	0.690	0.570	0.320
7,500	F							0.700	0.570	0.340
8,200	F							0.700	0.580	0.350

Note: Bold Outlined Sections indicate SUSCO Standard items.

SCDM 19 Mica Capacitors

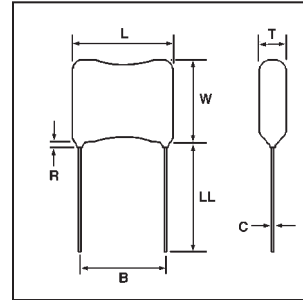

DIMENSIONS:
LL = 31.75 mm (1.25") min.

SCDM19

Case
Dimensions
in Millimeters

Lead Spacing:
8.73 ± 0.8mm

CAPACITANCE VALUE in pF	Characteristics	VOLTAGE								
		500 V DC			300 V DC			100 V DC		
		Lmax.	W max.	T max	Lmax.	W max.	T max	Lmax.	W max.	T max
100 - 240	F	15.49	11.43	3.30						
270 - 560	T	15.49	11.43	3.56						
620 - 820	F	15.49	11.68	3.81						
910 - 1,100	F	15.75	11.68	4.06						
1,200 - 1,500	F	15.75	11.68	4.32						
1,600 - 1,800	F	15.75	11.68	4.57						
2,000 - 2,200	F	16.00	11.68	4.83						
2,400	F	16.00	11.94	5.33						
2,700	F	16.00	11.94	5.59						
3,000	F	16.00	11.94	5.84						
3,300	F	16.00	12.19	6.10	16.00	10.67	5.33			
3,600	F	16.26	12.19	6.35	16.00	11.94	5.33			
3,900	F	16.26	12.19	6.60	16.00	11.94	5.33			
4,300	F	16.51	12.45	7.11	16.00	11.94	5.59			
4,700	F	16.51	12.45	7.62	16.00	11.94	5.84			
5,100	F	16.76	12.70	8.13	16.00	12.19	6.10			
5,600	F				16.26	12.19	6.35			
6,200	F				16.26	12.19	6.60	16.26	12.19	6.35
6,800	F				16.26	12.45	6.86	16.26	12.19	6.60
7,500	F							16.51	12.45	7.11
8,200	F							16.51	12.45	7.62

SCDM19

Case
Dimensions
in Inches

Lead Spacing:
0.344 ± 0.031"

CAPACITANCE VALUE in pF	Characteristics	VOLTAGE								
		500 V DC			300 V DC			100 V DC		
		Lmax.	W max.	T max	Lmax.	W max.	T max	Lmax.	W max.	T max
100 - 240	F	0.610	0.450	0.130						
270 - 560	F	0.610	0.450	0.140						
620 - 820	F	0.610	0.460	0.150						
910 - 1,100	F	0.620	0.460	0.160						
1,200 - 1,500	F	0.620	0.460	0.170						
1,600 - 1,800	F	0.620	0.460	0.180						
2,000 - 2,200	F	0.630	0.460	0.190						
2,400	F	0.630	0.470	0.210						
2,700	F	0.630	0.470	0.220						
3,000	F	0.630	0.470	0.230						
3,300	F	0.630	0.480	0.240	0.630	0.420	0.210			
3,600	F	0.640	0.480	0.250	0.630	0.470	0.210			
3,900	F	0.640	0.480	0.260	0.630	0.470	0.210			
4,300	F	0.650	0.490	0.280	0.630	0.470	0.220			
4,700	F	0.650	0.490	0.300	0.630	0.470	0.230			
5,100	F	0.660	0.500	0.320	0.630	0.480	0.240			
5,600	F				0.640	0.480	0.250			
6,200	F				0.640	0.480	0.260	0.640	0.480	0.250
6,800	F				0.640	0.490	0.270	0.640	0.480	0.260
7,500	F							0.650	0.490	0.280
8,200	F							0.650	0.490	0.300

Note: Bold Outlined Sections indicate SUSCO Standard items.

DM 20 Mica Capacitors

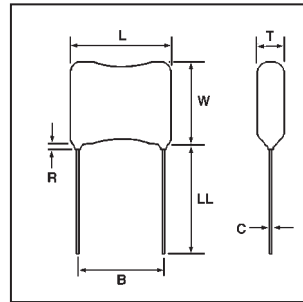

DIMENSIONS:
LL = 31.75 mm (1.25") min.

DM20
Case
Dimensions
in Millimeters

Lead Spacing:
11.11 ± 0.8mm

CAPACITANCE VALUE in pF	Characteristics	VOLTAGE								
		500 V DC			300 V DC			100 V DC		
		Lmax.	W max.	T max	Lmax.	W max.	T max	Lmax.	W max.	T max
680 - 1,200	F	19.05	12.95	5.08						
1,300 - 1,600	F	19.05	12.95	5.33						
1,800 - 2,200	F	19.30	13.21	5.59						
2,400	F	19.56	13.46	6.35						
2,700	F	19.56	13.72	6.60						
3,000	F	19.56	13.72	6.86						
3,300	F	19.81	13.97	7.11						
3,600	F	19.81	13.97	7.37						
3,900	F	19.81	14.22	7.62						
4,300	F	19.81	14.22	7.87	19.56	13.72	6.86			
4,700	F	20.07	14.22	8.13	19.56	13.72	6.86			
5,100	F	20.07	14.48	8.38	19.81	13.97	7.11			
5,600	F	20.07	14.48	8.64	19.81	13.97	7.37			
6,200	F	20.07	14.73	8.89	19.81	14.22	7.62	19.81	13.97	7.37
6,800	F	20.32	14.99	9.40	20.07	14.22	8.13	19.81	14.22	7.62
7,500	F	20.32	15.24	9.91	20.07	14.48	8.38	19.81	14.22	7.62
8,200	F	20.57	15.49	10.41	20.07	14.48	8.64	19.81	14.22	7.87
9,100	F	20.57	15.75	10.92	20.32	14.73	9.14	20.07	14.48	8.38
10,000	F	20.83	16.00	11.43	20.32	14.99	9.40	20.07	14.48	8.64
11,000	F				20.32	14.99	9.65	20.07	14.73	8.89
12,000	F				20.57	15.24	10.16	20.32	14.73	9.14

DM20
Case
Dimensions
in Inches

Lead Spacing:
0.438 ± 0.031"

CAPACITANCE VALUE in pF	Characteristics	VOLTAGE								
		500 V DC			300 V DC			100 V DC		
		Lmax.	W max.	T max	Lmax.	W max.	T max	Lmax.	W max.	T max
680 - 1,200	F	0.750	0.510	0.200						
1,300 - 1,600	F	0.750	0.510	0.210						
1,800 - 2,200	F	0.760	0.520	0.220						
2,400	F	0.770	0.530	0.250						
2,700	F	0.770	0.540	0.260						
3,000	F	0.770	0.540	0.270						
3,300	F	0.780	0.550	0.280						
3,600	F	0.780	0.550	0.290						
3,900	F	0.780	0.560	0.300						
4,300	F	0.780	0.560	0.310	0.770	0.540	0.270			
4,700	F	0.790	0.560	0.320	0.770	0.540	0.270			
5,100	F	0.790	0.570	0.330	0.780	0.550	0.280			
5,600	F	0.790	0.570	0.340	0.780	0.550	0.290			
6,200	F	0.790	0.580	0.350	0.780	0.560	0.300	0.780	0.550	0.290
6,800	F	0.800	0.590	0.370	0.790	0.560	0.320	0.780	0.560	0.300
7,500	F	0.800	0.600	0.390	0.790	0.570	0.330	0.780	0.560	0.300
8,200	F	0.810	0.610	0.410	0.790	0.570	0.340	0.780	0.560	0.310
9,100	F	0.810	0.620	0.430	0.800	0.580	0.360	0.790	0.570	0.330
10,000	F	0.820	0.630	0.450	0.800	0.590	0.370	0.790	0.570	0.340
11,000	F				0.800	0.590	0.380	0.790	0.580	0.350
12,000	F				0.810	0.600	0.400	0.800	0.580	0.360

Note: Bold Outlined Sections indicate SUSCO Standard items.

SCDM 20 Mica Capacitors

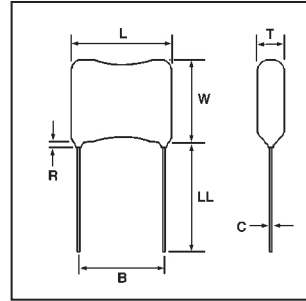

DIMENSIONS:
LL = 31.75 mm (1.25") min.

SCDM20
Case
Dimensions
in Millimeters

Lead Spacing:
11.11 ± 0.8mm

CAPACITANCE VALUE in pF	Characteristics	VOLTAGE								
		500 V DC			300 V DC			100 V DC		
		Lmax.	W max.	T max	Lmax.	W max.	T max	Lmax.	W max.	T max
1 - 100	F	17.78	11.43	3.05						
200 - 620	F	17.78	11.43	3.30						
750 - 1,200	F	17.78	11.43	3.56						
1,200 - 1,600	F	17.78	11.68	3.81						
1,800	F	18.03	11.68	3.81						
2,000 - 2,200	F	18.03	11.68	4.06						
2,400 - 2,700	F	18.03	11.68	5.08						
3,300 - 3,300	F	18.29	11.94	5.59						
3,600	F	18.29	11.94	5.84						
3,900	F	18.29	12.19	6.10						
4,300	F	18.29	12.19	6.35	18.29	11.94	5.33			
4,700	F	18.54	12.19	6.60	18.29	11.94	5.59			
5,100	F	18.54	12.45	6.86	18.29	11.94	5.84			
5,600	F	18.54	12.45	7.11	18.29	12.19	6.10			
6,200	F	18.80	12.45	7.62	18.29	12.19	6.35	18.29	11.94	5.59
6,800	F	18.80	12.70	8.13	18.54	12.19	6.60	18.29	11.94	5.84
7,500	F	19.05	12.70	8.64	18.54	12.45	6.86	18.29	12.19	6.10
8,200	F	19.05	12.95	9.14	18.54	12.45	7.11	18.29	12.19	6.35
9,100	F	19.30	13.21	9.65	18.80	12.45	7.37	18.54	12.19	6.60
10,000	F	19.30	13.46	10.16	18.80	12.45	7.62	18.54	12.45	6.86
11,000	F				18.80	12.70	8.13	18.54	12.45	7.11
12,000	F				19.05	12.70	8.64	18.80	12.45	7.37

SCDM20
Case
Dimensions
in Inches

Lead Spacing:
0.438 ± 0.031"

CAPACITANCE VALUE in pF	Characteristics	VOLTAGE								
		500 V DC			300 V DC			100 V DC		
		Lmax.	W max.	T max	Lmax.	W max.	T max	Lmax.	W max.	T max
1 - 100	F	0.700	0.450	0.120						
200 - 620	F	0.700	0.450	0.130						
750 - 1,200	F	0.700	0.450	0.140						
1,200 - 1,600	F	0.700	0.460	0.150						
1,800	F	0.710	0.460	0.150						
2,000 - 2,200	F	0.710	0.460	0.160						
2,400 - 2,700	F	0.710	0.460	0.200						
3,300 - 3,300	F	0.720	0.470	0.220						
3,600	F	0.720	0.470	0.230						
3,900	F	0.720	0.480	0.240						
4,300	F	0.720	0.480	0.250	0.720	0.470	0.210			
4,700	F	0.730	0.480	0.260	0.720	0.470	0.220			
5,100	F	0.730	0.490	0.270	0.720	0.470	0.230			
5,600	F	0.730	0.490	0.280	0.720	0.480	0.240			
6,200	F	0.740	0.490	0.300	0.720	0.480	0.250	0.720	0.470	0.220
6,800	F	0.740	0.500	0.320	0.730	0.480	0.260	0.720	0.470	0.230
7,500	F	0.750	0.500	0.340	0.730	0.490	0.270	0.720	0.480	0.240
8,200	F	0.750	0.510	0.360	0.730	0.490	0.280	0.720	0.480	0.250
9,100	F	0.760	0.520	0.380	0.740	0.490	0.290	0.730	0.480	0.260
10,000	F	0.760	0.530	0.400	0.740	0.490	0.300	0.730	0.490	0.270
11,000	F				0.740	0.500	0.320	0.730	0.490	0.280
12,000	F				0.750	0.500	0.340	0.740	0.490	0.290

Note: Bold Outlined Sections indicate SUSCO Standard items.

DM 30 / CM07 Mica Capacitors

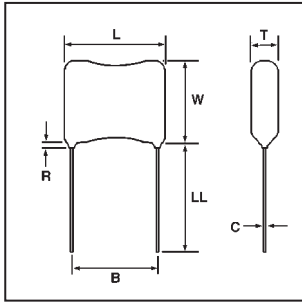

DIMENSIONS:
LL = 31.75 mm (1.25") min.

**DM30
CM07**
Case
Dimensions
in Millimeters

Lead Spacing:
11.11 ± 0.8mm

CAPACITANCE VALUE in pF	Characteristics	VOLTAGE					
		500 V DC			300 V DC		
		Lmax.	W max.	T max	Lmax.	W max.	T max
5,100	F	19.81	21.84	7.11			
5,600 - 6,200	F	19.81	22.10	7.37			
6,800	F	19.81	22.10	7.62			
7,500	F	20.07	22.35	7.87	19.81	21.84	6.86
8,200	F	20.07	22.35	8.13	19.81	21.84	7.11
9,100	F	20.07	22.35	8.38	19.81	22.10	7.11
10,000	F	20.32	22.61	8.64	19.81	22.10	7.37
11,000	F	20.32	22.61	8.89	19.81	22.10	7.62
12,000	F	20.32	22.61	9.14	20.07	22.35	7.87
13,000	F	20.57	22.61	9.40	20.07	22.35	7.87
15,000	F	20.57	22.86	9.91	20.07	22.35	8.38
16,000	F	20.83	22.86	10.41	20.32	22.61	8.64
18,000	F	20.83	23.11	10.92	20.32	22.61	9.14
20,000	F	21.08	23.37	11.43	20.57	22.61	9.40

**DM30
CM07**
Case
Dimensions
in Inches

Lead Spacing:
0.438 ± 0.031"

CAPACITANCE VALUE in pF	Characteristics	VOLTAGE					
		500 V DC			300 V DC		
		Lmax.	W max.	T max	Lmax.	W max.	T max
5,100	F	0.780	0.860	0.280			
5,600 - 6,200	F	0.780	0.870	0.290			
6,800	F	0.780	0.870	0.300			
7,500	F	0.790	0.880	0.310	0.780	0.860	0.270
8,200	F	0.790	0.880	0.320	0.780	0.860	0.280
9,100	F	0.790	0.880	0.330	0.780	0.870	0.280
10,000	F	0.800	0.890	0.340	0.780	0.870	0.290
11,000	F	0.800	0.890	0.350	0.780	0.870	0.300
12,000	F	0.800	0.890	0.360	0.790	0.880	0.310
13,000	F	0.810	0.890	0.370	0.790	0.880	0.310
15,000	F	0.810	0.900	0.390	0.790	0.880	0.330
16,000	F	0.820	0.900	0.410	0.800	0.890	0.340
18,000	F	0.820	0.910	0.430	0.800	0.890	0.360
20,000	F	0.830	0.920	0.450	0.810	0.890	0.370

Note: Bold Outlined Sections indicate SUSCO Standard items.

DM 42 Mica Capacitors

DM42
Case
Dimensions
in Millimeters

Lead Spacing:
26.99 ± 0.8mm

CAPACITANCE VALUE in pF	Characteristics	VOLTAGE								
		500 V DC			300 V DC			100 V DC		
		Lmax.	W max.	T max	Lmax.	W max.	T max	Lmax.	W max.	T max
16,000	F	35.81	22.10	7.11						
18,000	F	35.81	22.10	7.37						
20,000	F	36.07	22.10	7.62						
22,000	F	36.07	22.35	7.87	36.07	22.10	7.37			
24,000	F	36.32	22.35	8.13	36.07	22.10	7.62			
27,000	F	36.32	22.35	8.38	36.07	22.35	7.87	35.81	22.10	7.11
30,000	F	36.58	22.61	8.89	36.32	22.35	8.13	35.81	22.10	7.37
33,000	F	36.58	22.61	9.14	36.32	22.35	8.64	36.07	22.10	7.62
36,000	F	36.83	22.86	9.65	36.58	22.61	8.89	36.07	22.35	7.87
39,000	F	36.83	22.86	10.16	36.58	22.61	9.14	36.32	22.35	8.13
43,000	F	37.08	23.11	10.67	36.83	22.86	9.40	36.32	22.35	8.38
47,000	F	37.34	23.11	11.43	36.83	22.86	9.91	36.32	22.61	8.64
51,000	F	37.59	23.37	11.94	37.08	22.86	10.16	36.58	22.61	9.14
56,000	F				37.08	23.11	10.67	36.58	22.86	9.40
62,000	F				37.34	23.37	11.43	36.83	22.86	9.91
68,000	F				37.59	23.37	11.94	37.08	22.86	10.41
75,000	F							37.34	23.11	11.18
82,000	F							37.59	23.37	11.68

DM42
Case
Dimensions
in Inches

Lead Spacing:
1.063 ± 0.031"

CAPACITANCE VALUE in pF	Characteristics	VOLTAGE								
		500 V DC			300 V DC			100 V DC		
		Lmax.	W max.	T max	Lmax.	W max.	T max	Lmax.	W max.	T max
16,000	F	1.410	0.870	0.280						
18,000	F	1.410	0.870	0.290						
20,000	F	1.420	0.870	0.300						
22,000	F	1.420	0.880	0.310	1.420	0.870	0.290			
24,000	F	1.430	0.880	0.320	1.420	0.870	0.300			
27,000	F	1.430	0.880	0.330	1.420	0.880	0.310	1.410	0.870	0.280
30,000	F	1.440	0.890	0.350	1.430	0.880	0.320	1.410	0.870	0.290
33,000	F	1.440	0.890	0.360	1.430	0.880	0.340	1.420	0.870	0.300
36,000	F	1.450	0.900	0.380	1.440	0.890	0.350	1.420	0.880	0.310
39,000	F	1.450	0.900	0.400	1.440	0.890	0.360	1.430	0.880	0.320
43,000	F	1.460	0.910	0.420	1.450	0.900	0.370	1.430	0.880	0.330
47,000	F	1.470	0.910	0.450	1.450	0.900	0.390	1.430	0.890	0.340
51,000	F	1.480	0.920	0.470	1.460	0.900	0.400	1.440	0.890	0.360
56,000	F				1.460	0.910	0.420	1.440	0.900	0.370
62,000	F				1.470	0.920	0.450	1.450	0.900	0.390
68,000	F				1.480	0.920	0.470	1.460	0.900	0.410
75,000	F							1.470	0.910	0.440
82,000	F							1.480	0.920	0.460

Note: Bold Outlined Sections indicate SUSCO Standard items.

Tape/Reel & Packaging Specifications

Taping Specifications

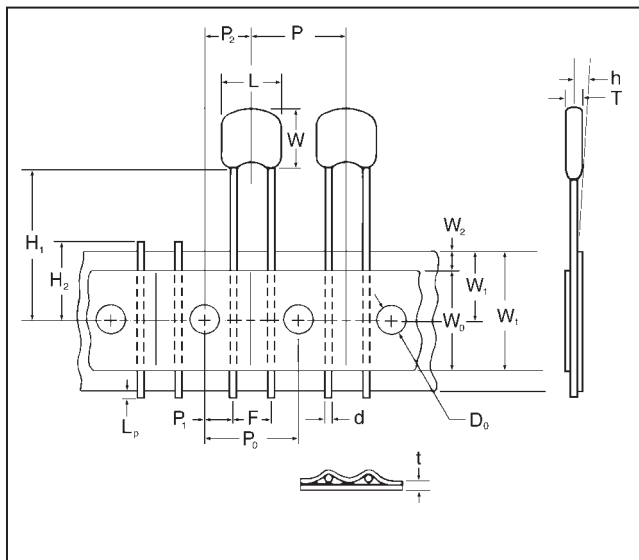

Reel and Ammo Specifications

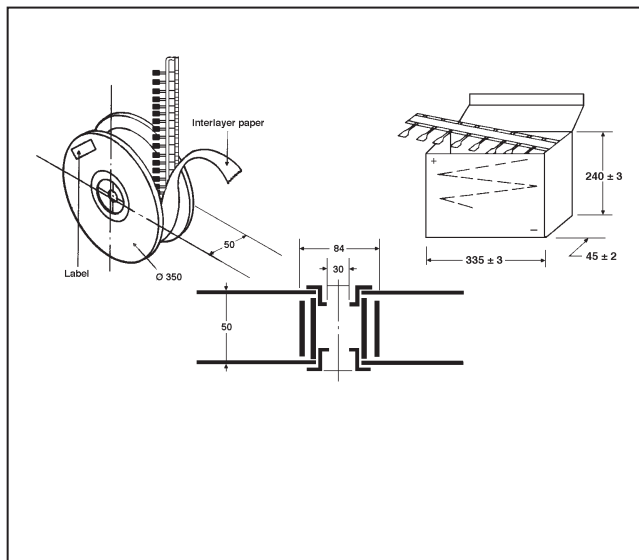

Taping Dimensions

ITEM	Symbol	Specifications (mm)		Specifications (inches)	
		Value	Tol.	Value	Tol.
Body width	L	L	max.	L	max.
Body height	W	W	max.	W	max.
Body thickness	T	T	max.	T	max.
Lead-wire diameter	d	0.5	±0.05	0.020	±0.002
Pitch of components	P	12.7	±1.0	0.500	±0.039
Sprocket hole pitch	P ₀	12.7	±0.3	0.500	±0.12
Lead location	P ₁	3.85	±0.7	0.152	±0.028
Hole center to component center	P ₂	6.35	±1.3	0.250	±0.051
Component lead spacing	F	5	+0.6 to -0.2	0.197	+0.024 to -0.008
Deflection	h	0	±2.0	0.000	±0.079
Carrier tape width	W _t	18	±1.0 to -.05	0.709	±0.039 to -0.002
Hold down tape width	W ₀	12.5	min.	0.492	min.
Sprocket hole location	W ₁	9	±0.5	0.354	±0.020
Adhesive tape border	W ₂	3	max.	0.118	max.
Length of scating plans	H ₁	16	±0.5	0.630	±0.020
Lead-wire protrusion	L _p	2	max.	0.079	max.
Sprocket hole diameter	D ₀	4	±0.2	0.157	±0.008
Overall tape thickness	t	0.7	±0.2	0.028	±0.008
Cut out length	H ₂	11	max.	0.433	max.

Bulk Pack Quantity

Product		Std. Quantity
DM Series	Single Coat	per Bag
DM05	SCDM05	500 pcs.
DM10	SCDM10	500 pcs.
DM12	SCDM12	500 pcs.
DM15	SCDM15	500 pcs.
DM19	SCDM19	250 pcs.
DM20	SCDM20	250 pcs.
DM30		100 pcs.
DM42		50 pcs.

Reel Pack Quantity

Series	Quantity per Reel (min.)
DM12	1K pcs.
DM15	1K pcs.

Ammo Pack Quantity

Series	Quantity per Reel (min.)
DM12	1K pcs.
DM15	1K pcs.

All Dipped Mica capacitors are shipped in bulk packing. Tape and Reel format available for DM12 and DM15 capacitors upon request and meet EIA standards.

Dipped Mica capacitors are also available with various lead forming and trimming options. Please provide specific requirements