

PKM 4000B PI series Intermediate Bus Converters
 Input 36-75 V, Output up to 33 A / 380 W

EN/LZT 146 305 R5C March 2010

© Ericsson AB

Key Features

- Industry standard Quarter-brick
 57.9 x 36.8 x 11.6 mm (2.28 x 1.45 x 0.46 in.)
- High efficiency, typ. 96 % at 12 Vout 50% load & 48Vin
- 1500 Vdc input to output isolation
- Meets safety requirements according to IEC/EN/UL 60950
- More than 1.1 million hours MTBF



General Characteristics

- N+1 parallelable
- Input under voltage protection
- Over temperature protection
- Output over voltage protection
- Output short-circuit protection
- Remote control
- Optional latching OTP, OVP
- Optional baseplate
- Optional case to ground pin (only with baseplate)
- Highly automated manufacturing ensures quality
- ISO 9001/14001 certified supplier

Safety Approvals



Design for Environment



RoHS
 compliant 

Meets requirements in high-temperature lead-free soldering processes.

Contents

General Information	2
Safety Specification	3
Absolute Maximum Ratings	4
Product Program	Ordering No.	
12.0 V/25 A Electrical Specification	PKM 4204B PI	5
12.0 V/33 A Electrical Specification	PKM 4304B PI	9
EMC Specification	13
Operating Information	14
Thermal considerations	16
Connections	17
Mechanical Information	18
Soldering Information	20
Delivery Information	20
Product Qualification Specification	21

PKM 4000B PI series Intermediate Bus Converters
 Input 36-75 V, Output up to 33 A / 380 W

EN/LZT 146 305 R5C March 2010

© Ericsson AB

General Information
Ordering Information

See Contents for individual product ordering numbers.

Option	Suffix	Ordering No.
Positive Remote Control Logic	P	PKM 4304B PIP
Lead length 3.69 mm (0.145 in)	LA	PKM 4304B PILA
Lead length 4.57 mm (0.180 in)	LB	PKM 4304B PILB
Lead length 2.79 mm (0.110 in)	LC	PKM 4304B PILC
Baseplate	HS	PKM 4304B PIHS
Case to ground pin (*)	G	PKM 4304B PIHSG
Latching protections (OTP,OVP)	LP	PKM 4304B PILP

Note: (1) Case to ground pin only available with baseplate

Note: (2) If several options needed below sequence is to be used

LOGIC OPTION → LATCHING PROT. → BASEPLATE → CASE GROUND → PIN LENGTH, example: PKM4304BPIPLPHSGLA

Reliability

The Mean Time Between Failure (MTBF) is calculated at full output power and an operating ambient temperature (T_A) of +40°C. Different methods could be used to calculate the predicted MTBF and failure rate which may give different results. Ericsson Power Modules currently uses two different methods, Ericsson failure rate data system DependTool and Telcordia SR332.

Predicted MTBF for the series is:

- 1.8 million hours according to Telcordia SR332, issue 1, Black box technique.

The Ericsson failure rate data system is based on field tracking data. The data corresponds to actual failure rates of components used in Information Technology and Telecom (IT&T) equipment in temperature controlled environments ($T_A = -5...+65^\circ\text{C}$). Telcordia SR332 is a commonly used standard method intended for reliability calculations in IT&T equipment. The parts count procedure used in this method was originally modelled on the methods from MIL-HDBK-217F, Reliability Predictions of Electronic Equipment.

It assumes that no reliability data is available on the actual units and devices for which the predictions are to be made, i.e. all predictions are based on generic reliability parameters.

Compatibility with RoHS requirements

The products are compatible with the relevant clauses and requirements of the RoHS directive 2002/95/EC and have a maximum concentration value of 0.1% by weight in homogeneous materials for lead, mercury, hexavalent chromium, PBB and PBDE and of 0.01% by weight in homogeneous materials for cadmium.

Exemptions in the RoHS directive utilized in Ericsson Power Modules products include:

- Lead in high melting temperature type solder (used to solder the die in semiconductor packages)
- Lead in glass of electronics components and in electronic ceramic parts (e.g. fill material in chip resistors)
- Lead as an alloying element in copper alloy containing up to 4% lead by weight (used in connection pins made of Brass)

Quality Statement

The products are designed and manufactured in an industrial environment where quality systems and methods like ISO 9000, 6 σ (sigma), and SPC are intensively in use to boost the continuous improvements strategy. Infant mortality or early failures in the products are screened out and they are subjected to an ATE-based final test. Conservative design rules, design reviews and product qualifications, plus the high competence of an engaged work force, contribute to the high quality of our products.

Warranty

Warranty period and conditions are defined in Ericsson Power Modules General Terms and Conditions of Sale.

Limitation of Liability

Ericsson power Modules does not make any other warranties, expressed or implied including any warranty of merchantability or fitness for a particular purpose (including, but not limited to, use in life support applications, where malfunctions of product can cause injury to a person's health or life).

PKM 4000B PI series Intermediate Bus Converters
Input 36-75 V, Output up to 33 A / 380 W

EN/LZT 146 305 R5C March 2010

© Ericsson AB

Safety Specification**General information**

Ericsson Power Modules DC/DC converters and DC/DC regulators are designed in accordance with safety standards IEC/EN/UL60950, *Safety of Information Technology Equipment*.

IEC/EN/UL60950 contains requirements to prevent injury or damage due to the following hazards:

- Electrical shock
- Energy hazards
- Fire
- Mechanical and heat hazards
- Radiation hazards
- Chemical hazards

On-board DC-DC converters are defined as component power supplies. As components they cannot fully comply with the provisions of any Safety requirements without "Conditions of Acceptability". It is the responsibility of the installer to ensure that the final product housing these components complies with the requirements of all applicable Safety standards and Directives for the final product.

Component power supplies for general use should comply with the requirements in IEC60950, EN60950 and UL60950 "*Safety of information technology equipment*".

There are other more product related standards, e.g. EC61204-7 "Safety standard for power supplies", IEEE802.3af "Ethernet LAN/MAN Data terminal equipment power", and ETS300132-2 "Power supply interface at the input to telecommunications equipment; part 2: DC", but all of these standards are based on IEC/EN/UL60950 with regards to safety. PKM-B has the following stand-off (see mechanical drawing for further information):

- 0.7 mm stand-off to tallest insulated part (signal transformer's plastic housing)

- 0.7 mm stand-off to tallest unconnected (floating) conductive part (the integrated transformer's and output inductor's ferrite cores)

- 0.95 mm stand-off to tallest connected conductive part (input- and output capacitors)

Ericsson Power Modules DC/DC converters and DC/DC regulators are UL60950 recognized and certified in accordance with EN60950.

The flammability rating for all construction parts of the products meets requirements for V-0 class material according to IEC 60695-11-10.

The products should be installed in the end-use equipment, in accordance with the requirements of the ultimate application. Normally the output of the DC/DC converter is considered as SELV (Safety Extra Low Voltage) and the input source must be isolated by minimum Double or Reinforced Insulation from the primary circuit (AC mains) in accordance with IEC/EN/UL60950.

Isolated DC/DC converters

It is recommended that a slow blow fuse with a rating twice the maximum input current per selected product be used at the input of each DC/DC converter. If an input filter is used in the circuit the fuse should be placed in front of the input filter.

In the rare event of a component problem in the input filter or in the DC/DC converter that imposes a short circuit on the input source, this fuse will provide the following functions:

- Isolate the faulty DC/DC converter from the input power source so as not to affect the operation of other parts of the system.
- Protect the distribution wiring from excessive current and power loss thus preventing hazardous overheating.

The galvanic isolation is verified in an electric strength test. The test voltage (V_{iso}) between input and output is 1500 Vdc or 2250 Vdc for 60 seconds (refer to product specification).

Leakage current is less than 100 μ A at nominal input voltage.

24 V DC systems

The input voltage to the DC/DC converter is SELV (Safety Extra Low Voltage) and the output remains SELV under normal and abnormal operating conditions.

48 and 60 V DC systems

If the input voltage to Ericsson Power Modules DC/DC converter is 75 Vdc or less, then the output remains SELV (Safety Extra Low Voltage) under normal and abnormal operating conditions.

Single fault testing in the input power supply circuit should be performed with the DC/DC converter connected to demonstrate that the input voltage does not exceed 75 Vdc.

If the input power source circuit is a DC power system, the source may be treated as a TNV2 circuit and testing has demonstrated compliance with SELV limits and isolation requirements equivalent to Basic Insulation in accordance with IEC/EN/UL60950.

Non-isolated DC/DC regulators

The input voltage to the DC/DC regulator is SELV (Safety Extra Low Voltage) and the output remains SELV under normal and abnormal operating conditions.

PKM 4000B PI series Intermediate Bus Converters
 Input 36-75 V, Output up to 33 A / 380 W

EN/LZT 146 305 R5C March 2010

© Ericsson AB

Absolute Maximum Ratings

Characteristics		min	typ	max	Unit
T _{ref}	Operating Temperature (see Thermal Consideration section)	Open frame		+125	°C
		Base plate option		+95	
T _s	Storage temperature	-55		+125	°C
V _I	Input voltage	-0.5		+80	V
V _{iso}	Isolation voltage (input to output test voltage)			1500	Vdc
V _{tr}	Input voltage transient (t _p 100 ms)			100	V
V _{RC}	Remote Control pin voltage (see Operating Information section)	Positive logic option		15	V
		Negative logic option	-0.5	15	

Stress in excess of Absolute Maximum Ratings may cause permanent damage. Absolute Maximum Ratings, sometimes referred to as no destruction limits, are normally tested with one parameter at a time exceeding the limits of Output data or Electrical Characteristics. If exposed to stress above these limits, function and performance may degrade in an unspecified manner.

Fundamental Circuit Diagram

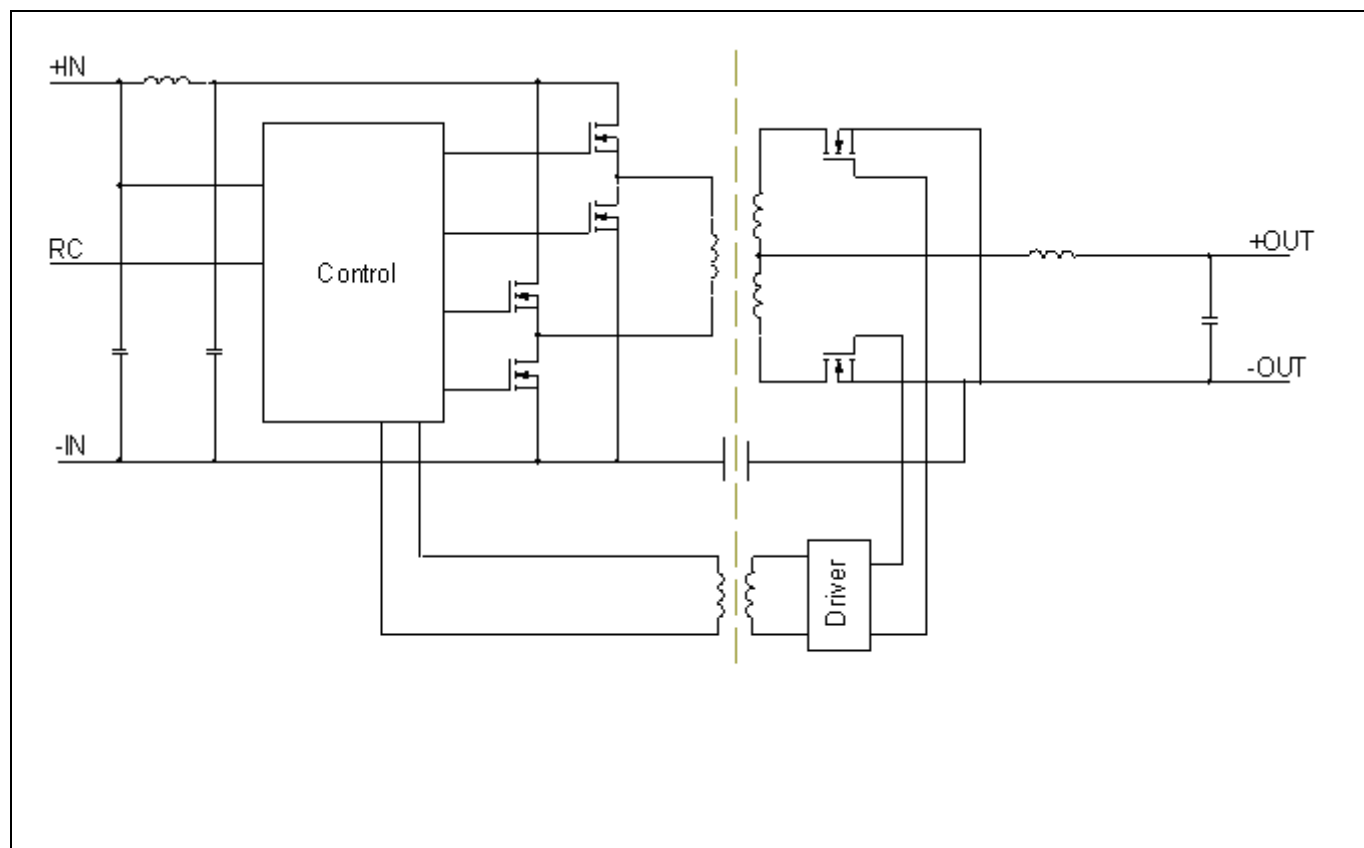

PKM 4000B PI series Intermediate Bus Converters
 Input 36-75 V, Output up to 33 A / 380 W

EN/LZT 146 305 R5C March 2010

© Ericsson AB

12 V/25 A Electrical Specification
PKM 4204B PI

$T_{ref} = -40$ to $+90^{\circ}$ C for open frame and -40 to $+60^{\circ}$ C for base plate option, $V_I = 36$ to 75 V, $I_O = 0$ to 25 A unless otherwise specified under Conditions.

Typical values given at: $T_{ref} = +25^{\circ}$ C, $V_I = 53$ V, max I_O , unless otherwise specified under Conditions.

Characteristics		Conditions	Min	typ	max	Unit
V_I	Input voltage range		36		75	V
V_{loff}	Turn-off input voltage	Decreasing input voltage	32	33	34	V
V_{lon}	Turn-on input voltage	Increasing input voltage	34	35.2	36	V
C_I	Internal input capacitance			17.6		μ F
P_O	Output power	$V_I = 75$ V	0		290	W
		$V_I = 53$ V	0		286	W
		$V_I = 36$ V	0		283	W
η	Efficiency	50 % of max I_O		96.2		%
		max I_O		95.8		
		50 % of max I_O , $V_I = 48$ V		96.4		
		max I_O , $V_I = 48$ V		95.9		
P_d	Power Dissipation	max I_O		12.4		W
P_{ii}	Input idling power	$I_O = 0$ A, $V_I = 53$ V		3		W
P_{RC}	Input standby power	$V_I = 53$ V (turned off with RC)		0.1		W
f_s	Switching frequency		100	125	150	kHz

V_{oi}	Output voltage initial setting and accuracy	$T_{ref} = +25^{\circ}$ C, $V_I = 53$ V, $I_O = 0$ A	11.85	11.9	11.95	V
V_O	Output voltage tolerance band	0 to 100 % of max I_O	11.0		12.5	V
	Idling voltage	$I_O = 0$ A	11.5		12.5	V
	Line regulation	max I_O , from min V_I to max V_I		0.2		V
	Load regulation	$V_I = 53$ V, from min I_O to max I_O		0.4		V
V_{tr}	Load transient voltage deviation	$V_I = 53$ V, Load step 25-75-25 % of max I_O , $di/dt = 5$ A/ μ s		± 0.8		V
t_{tr}	Load transient recovery time	see Note 1		0.1		ms
t_r	Ramp-up time (from 10-90 % of V_{oi})	max I_O	3	7	15	ms
t_s	Start-up time (from V_I connection to 90 % of V_{oi})		4	12	25	ms
t_f	V_I shut-down fall time (from V_I off to 10 % of V_O)	max I_O		0.1		ms
		$I_O = 0$ A		2.4		s
t_{RC}	RC start-up time	max I_O		10		ms
	RC shut-down fall time (from RC off to 10 % of V_O)	max I_O		6		ms
		$I_O = 0$ A		2.4		s
I_O	Output current		0		25	A
I_{lim}	Current limit threshold	$T_{ref} < \max T_{ref}$		36		A
I_{sc}	Short circuit current	$T_{ref} = 25^{\circ}$ C, see Note 2		42		A
V_{Oac}	Output ripple & noise	See ripple & noise section, max I_O		200		mVp-p
OVP	Input over voltage protection			83		V
	Output over voltage protection			13.5		

Note 1: Output filter 2 x 220 μ F, 100 m Ω , tantalum + 33 μ F, ceramic

Note 2: See Operating Information section

PKM 4000B PI series Intermediate Bus Converters
 Input 36-75 V, Output up to 33 A / 380 W

EN/LZT 146 305 R5C March 2010

© Ericsson AB

12 V/25 A Typical Characteristics

PKM 4204B PI

Efficiency

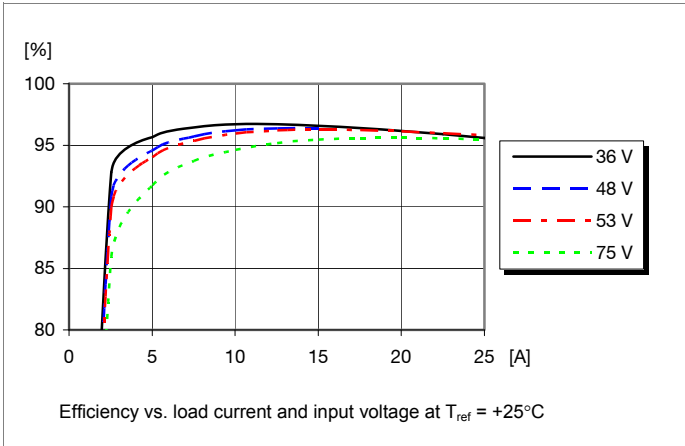

Power Dissipation

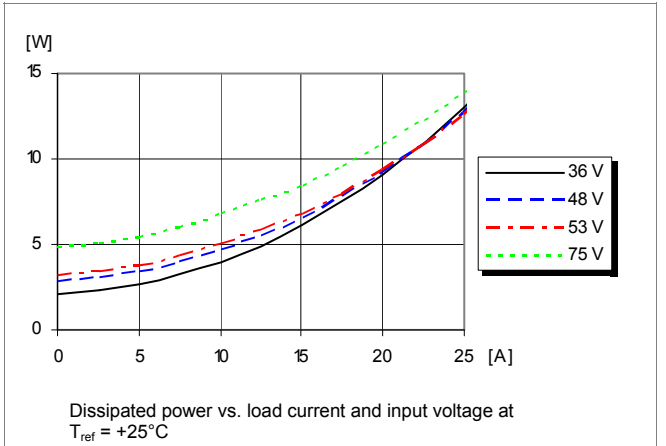

Output Characteristics

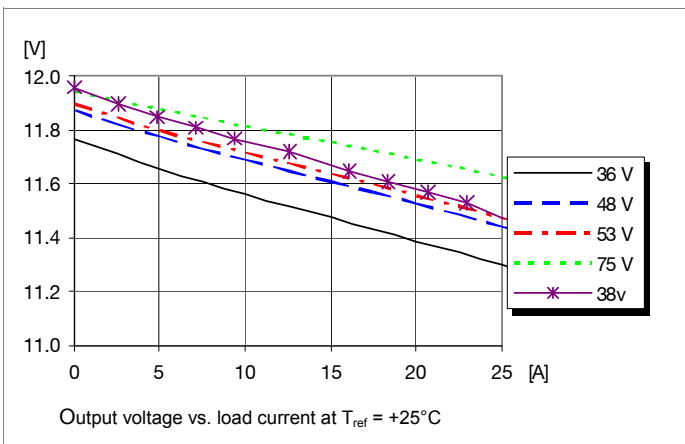

Current Limit Characteristics

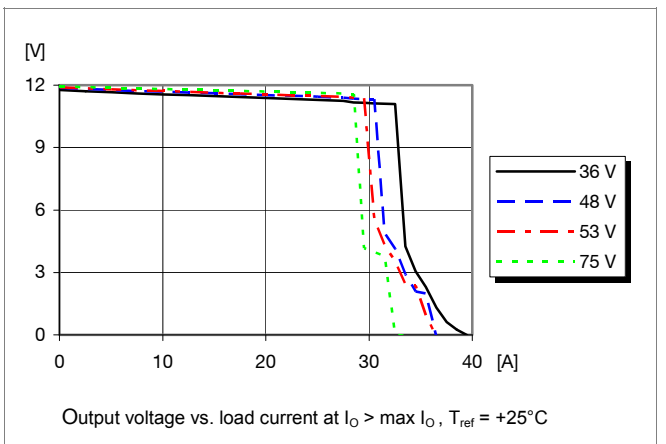

PKM 4000B PI series Intermediate Bus Converters
 Input 36-75 V, Output up to 33 A / 380 W

EN/LZT 146 305 R5C March 2010

© Ericsson AB

12 V/25 A Typical Characteristics

PKM 4204B PI

Output Current Derating, open frame

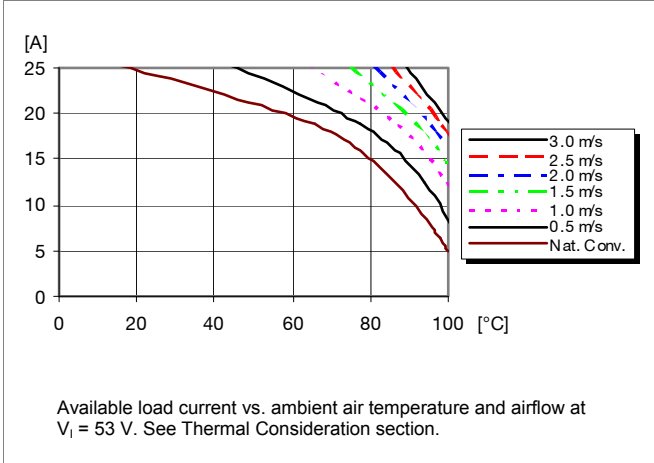

Thermal Resistance, open frame

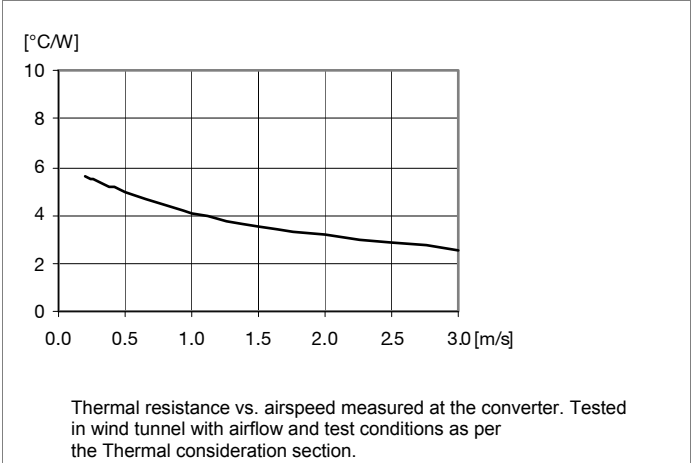

Output Current Derating, base plate option

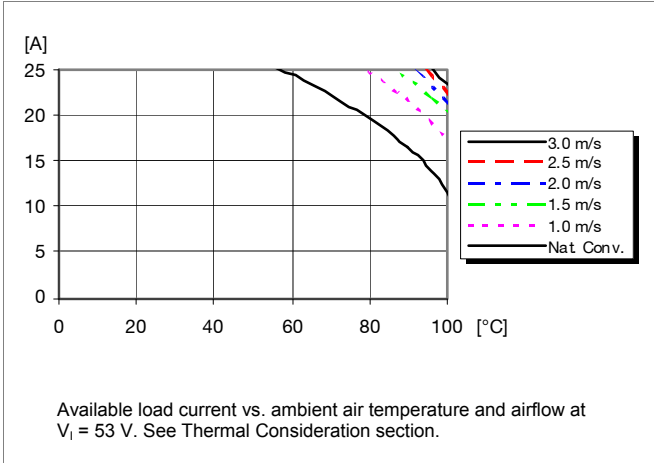

Thermal Resistance, base plate option

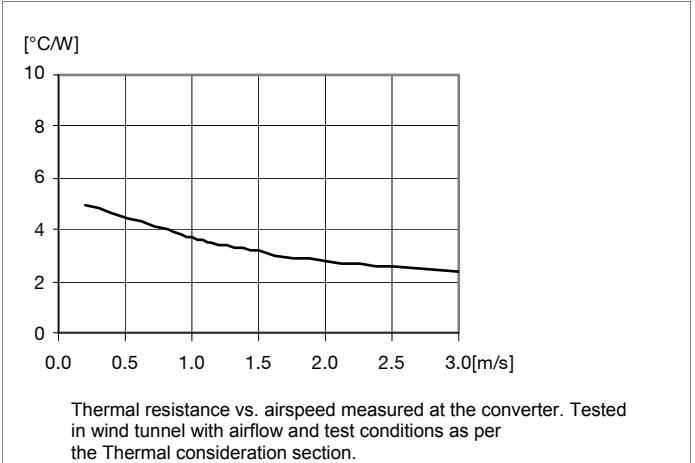

Output Current Derating, base plate option with heat sink

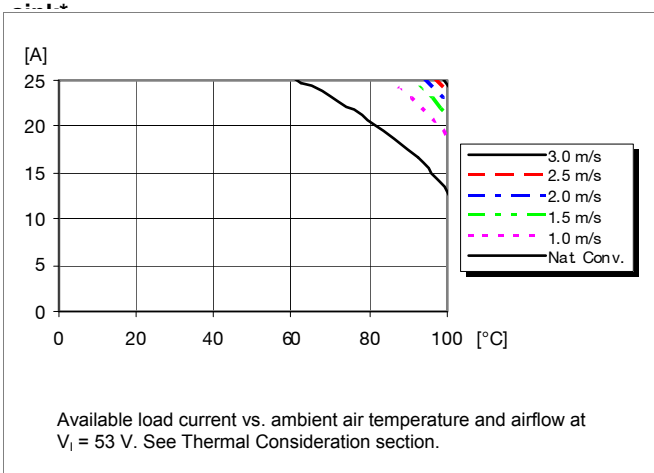

Thermal Resistance, base plate option with heat sink*

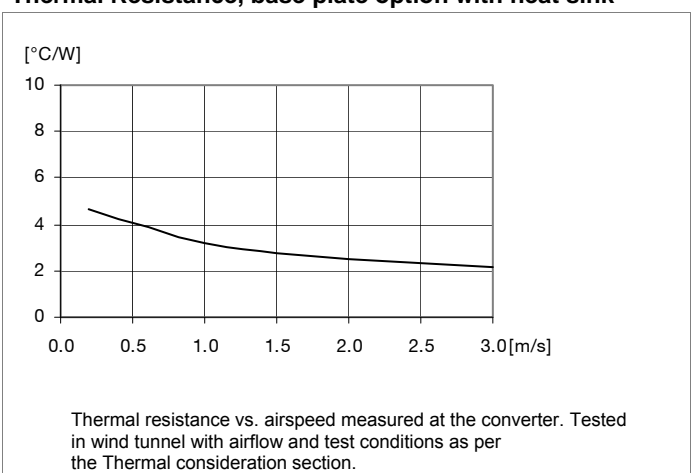

*¹⁾ Heat sink: finned aluminium, height: 0.23"; Thermal pad: thermal conductivity: 6W/mK, thickness: 0.25mm; Mounting: two M3 screws, torque: 0.44Nm
 NOTE: the product is not mechanically tested with heat sink

PKM 4000B PI series Intermediate Bus Converters
 Input 36-75 V, Output up to 33 A / 380 W

EN/LZT 146 305 R5C March 2010

© Ericsson AB

12 V/25 A Typical Characteristics

PKM 4204B PI

Start-up

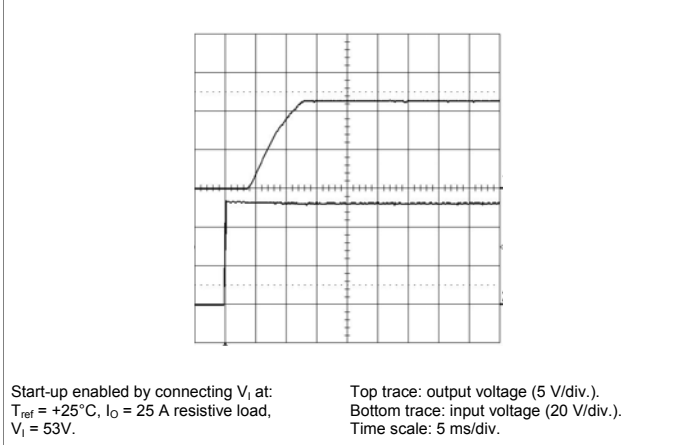

Shut-down

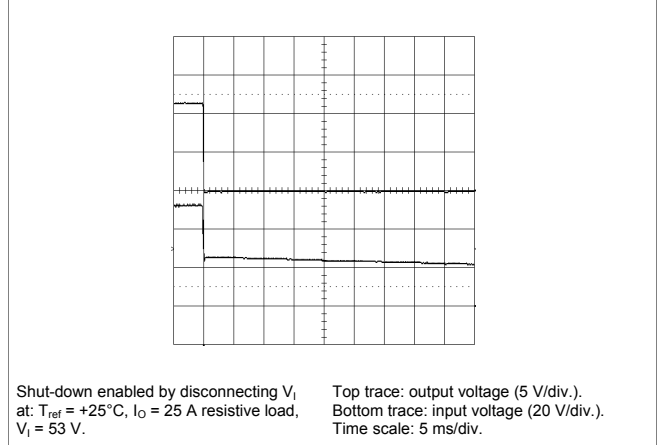

Output Ripple & Noise

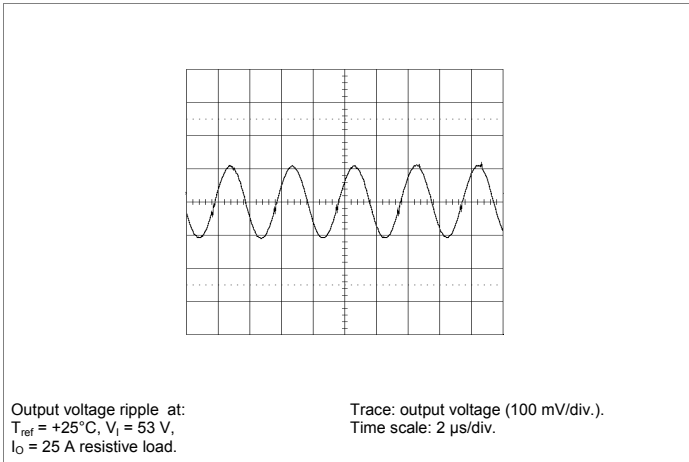

Output Load Transient Response

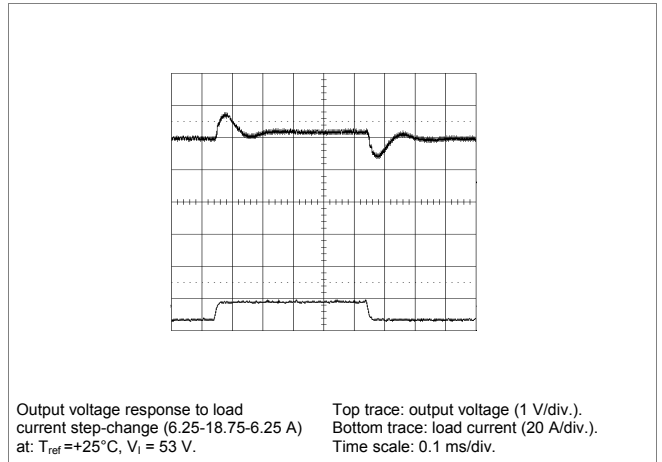

PKM 4000B PI series Intermediate Bus Converters
 Input 36-75 V, Output up to 33 A / 380 W

EN/LZT 146 305 R5C March 2010

© Ericsson AB

12 V/33 A Electrical Specification
PKM 4304B PI
 $T_{ref} = -40$ to $+90^{\circ}\text{C}$ for open frame and -40 to $+60^{\circ}\text{C}$ for base plate option, $V_i = 36$ to 75 V, $I_o = 0$ to 33 A unless otherwise specified under Conditions.

 Typical values given at: $T_{ref} = +25^{\circ}\text{C}$, $V_i = 53$ V, max I_o , unless otherwise specified under Conditions.

Characteristics		Conditions	min	typ	max	Unit
V_i	Input voltage range		36		75	V
V_{loff}	Turn-off input voltage	Decreasing input voltage	32	33	34	V
V_{lon}	Turn-on input voltage	Increasing input voltage	34	35.2	36	V
C_i	Internal input capacitance			17.6		μF
P_o	Output power	$V_i = 75$ V	0		380	W
		$V_i = 53$ V	0		377	W
		$V_i = 36$ V	0		371	W
η	Efficiency	50 % of max I_o		96.3		%
		max I_o		95.2		
		50 % of max I_o , $V_i = 48$ V		96.4		
		max I_o , $V_i = 48$ V		95.3		
P_d	Power Dissipation	max I_o		18	34	W
P_{ii}	Input idling power	$I_o = 0$ A, $V_i = 53$ V		4		W
P_{RC}	Input standby power	$V_i = 53$ V (turned off with RC)		0.1		W
f_s	Switching frequency		100	125	150	kHz

V_{oi}	Output voltage initial setting and accuracy	$T_{ref} = +25^{\circ}\text{C}$, $V_i = 53$ V, $I_o = 0$ A	11.85	11.9	11.95	V
V_o	Output voltage tolerance band	0 to 100 % of max I_o	10.8		12.5	V
	Idling voltage	$I_o = 0$ A	11.5		12.5	V
	Line regulation	max I_o , from min V_i to max V_i		0.2	0.6	V
	Load regulation	$V_i = 53$ V, from min I_o to max I_o		0.5	0.9	V
V_{tr}	Load transient voltage deviation	$V_i = 53$ V, Load step 25-75-25 % of max I_o , $di/dt = 5$ A/ μs see Note 1		± 1		V
t_{tr}	Load transient recovery time			0.1		ms
t_r	Ramp-up time (from 10-90 % of V_{oi})	max I_o	3	7	15	ms
t_s	Start-up time (from V_i connection to 90 % of V_{oi})		4	12	25	ms
t_f	V_i shut-down fall time (from V_i off to 10 % of V_o)	max I_o		0.1		ms
		$I_o = 0$ A		2.4		s
t_{RC}	RC start-up time	max I_o		10		ms
	RC shut-down fall time (from RC off to 10 % of V_o)	max I_o		6		ms
		$I_o = 0$ A		2.4		s
I_o	Output current		0		33	A
I_{lim}	Current limit threshold	$T_{ref} < \max T_{ref}$		41		A
I_{sc}	Short circuit current	$T_{ref} = 25^{\circ}\text{C}$, see Note 2		47		A
V_{Oac}	Output ripple & noise	See ripple & noise section, max I_o		200		mVp-p
OVP	Input over voltage protection			83		V
	Output over voltage protection			13.5		

 Note 1: Output filter 2 x 220 μF , 100 m Ω , tantalum + 33 μF , ceramic

Note 2: See Operating Information section

PKM 4000B PI series Intermediate Bus Converters
 Input 36-75 V, Output up to 33 A / 380 W

EN/LZT 146 305 R5C March 2010

© Ericsson AB

12 V/33 A Typical Characteristics

PKM 4304B PI

Efficiency

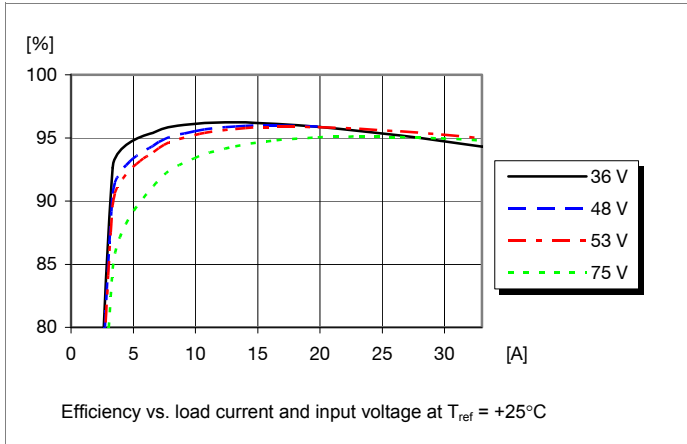

Power Dissipation

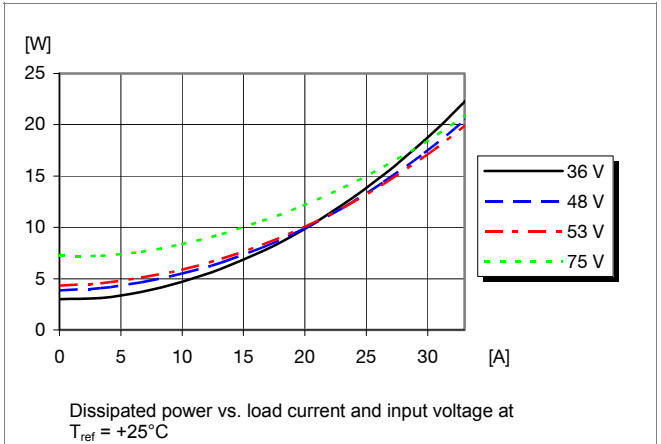

Output Characteristics

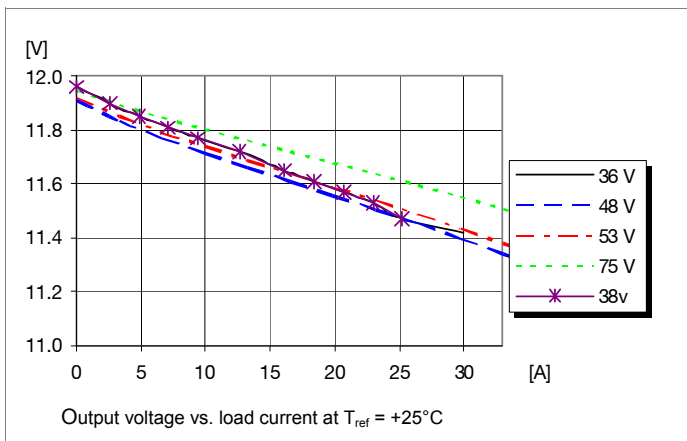

Current Limit Characteristics

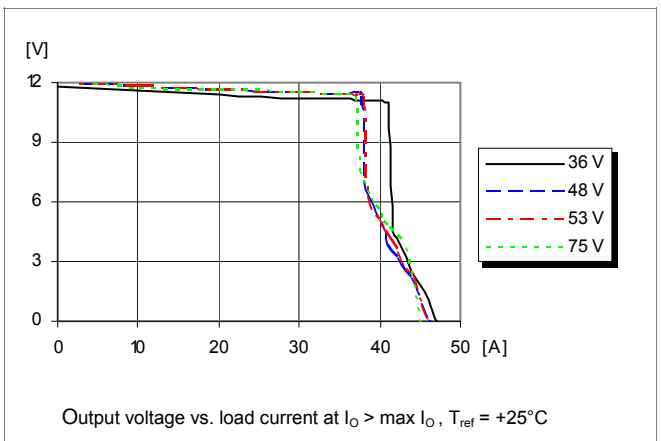

PKM 400B PI series Intermediate Bus Converters
 Input 36-75 V, Output up to 33 A / 380 W

EN/LZT 146 305 R5C March 2010

© Ericsson AB

12 V/33 A Typical Characteristics

PKM 4304B PI

Output Current Derating, open frame

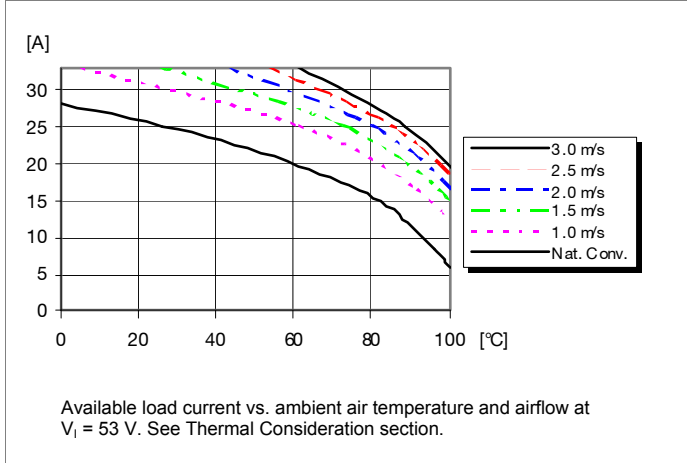

Thermal Resistance, open frame

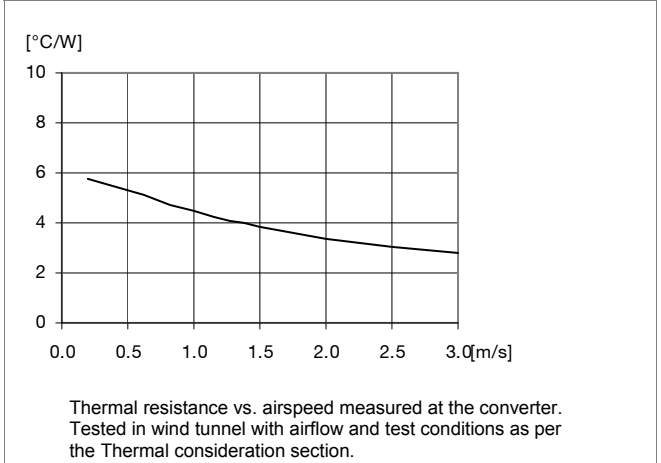

Output Current Derating, base plate option

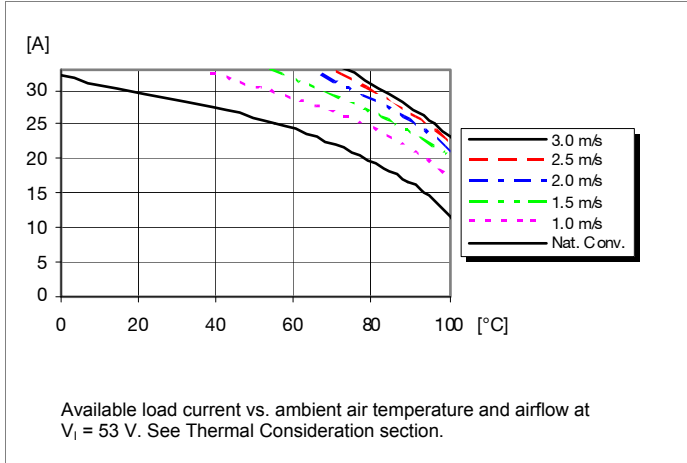

Thermal Resistance, base plate option

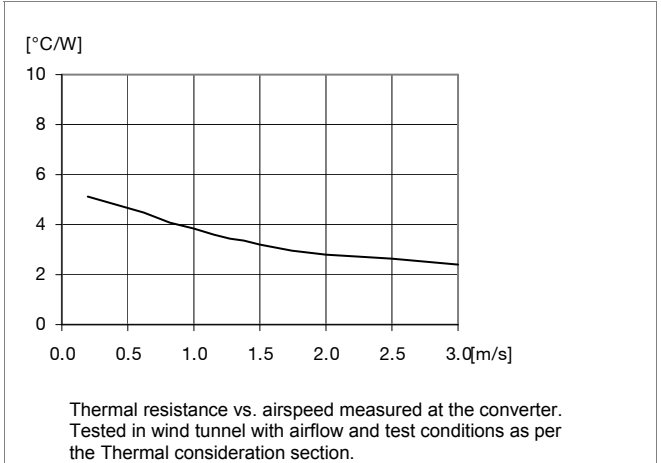

Output Current Derating, base plate option with heat sink*

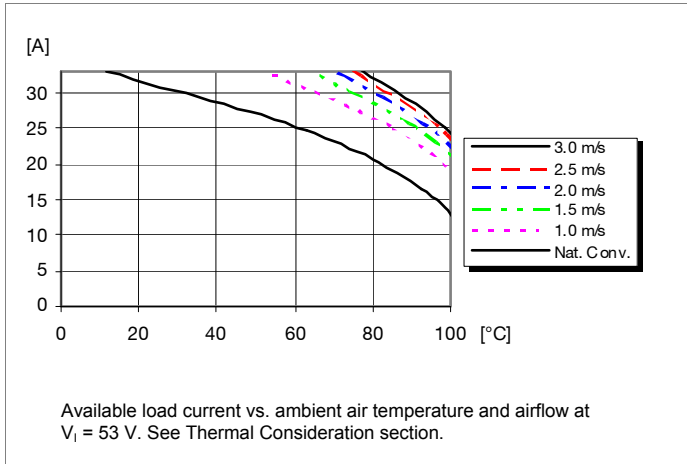

Thermal Resistance, base plate option with heat sink*

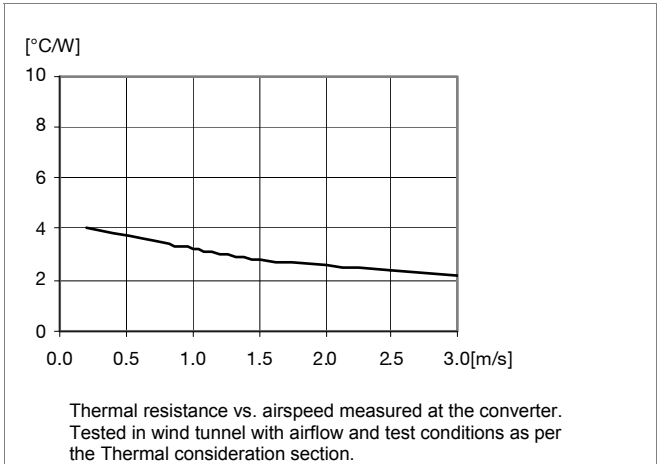

*¹) Heat sink: finned aluminium, height: 0.23"; Thermal pad: thermal conductivity: 6W/mK, thickness: 0.25mm; Mounting: two M3 screws, torque: 0.44Nm
 NOTE: the product is not mechanically tested with heat sink

PKM 4000B PI series Intermediate Bus Converters
 Input 36-75 V, Output up to 33 A / 380 W

EN/LZT 146 305 R5C March 2010

© Ericsson AB

12 V/33 A Typical Characteristics

PKM 4304B PI

Start-up

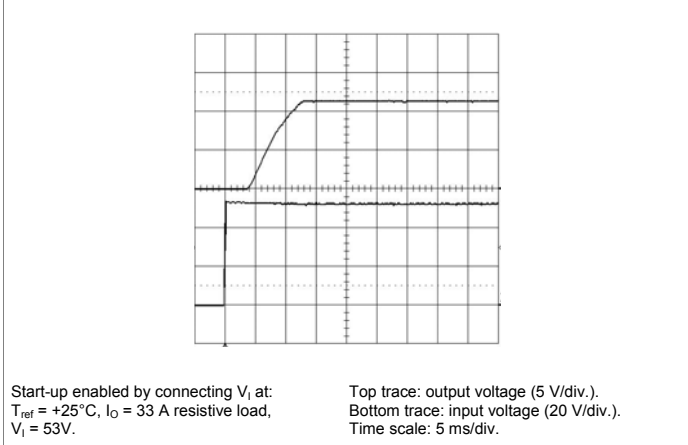

Shut-down

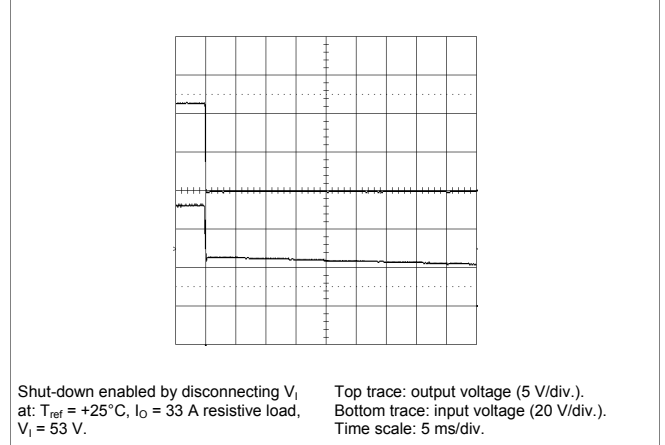

Output Ripple & Noise

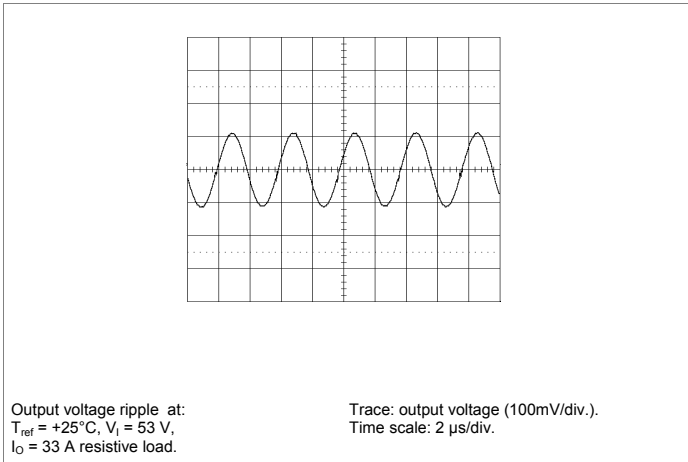

Output Load Transient Response

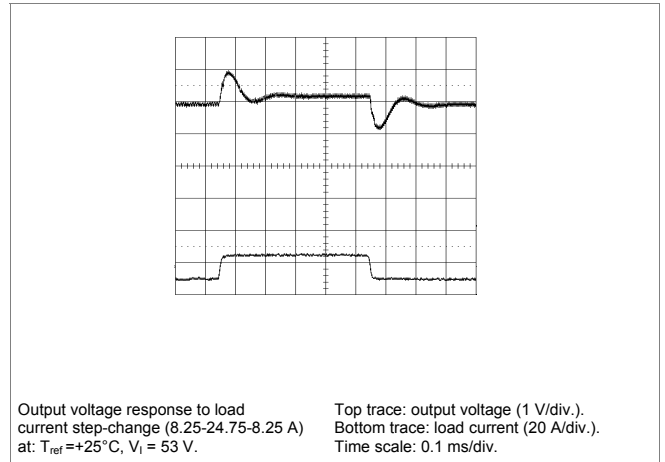

PKM 4000B PI series Intermediate Bus Converters
 Input 36-75 V, Output up to 33 A / 380 W

EN/LZT 146 305 R5C March 2010

© Ericsson AB

EMC Specification

Conducted EMI measured according to EN55022, CISPR 22 and FCC part 15J (see test set-up). See Design note 009 for detailed information.
 The fundamental switching frequency is 125 kHz for PKM 4304B PI @ $V_I = 53$ V, max I_O .

Conducted EMI Input terminal value (typ)

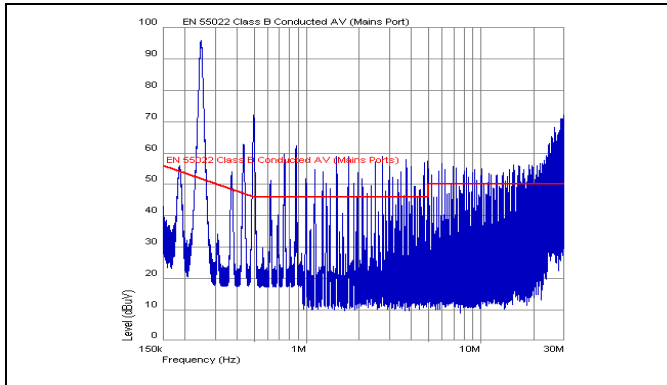

EMI without filter

External filter (class B)

Required external input filter in order to meet class B in EN 55022, CISPR 22 and FCC part 15J.

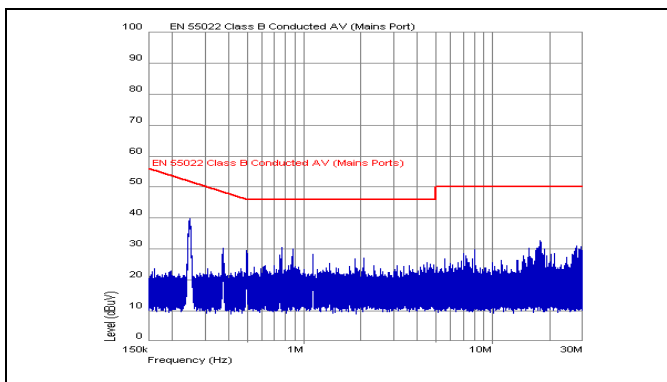
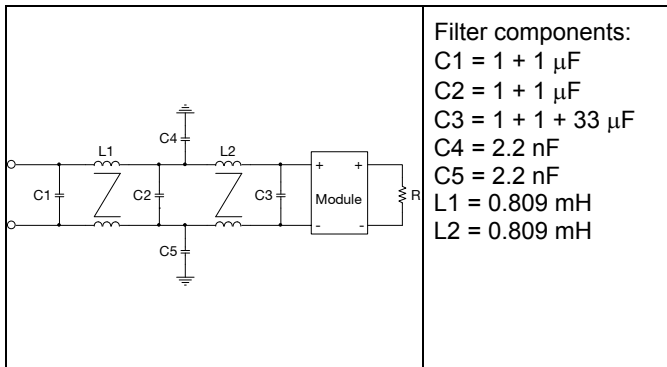

EMI with filter

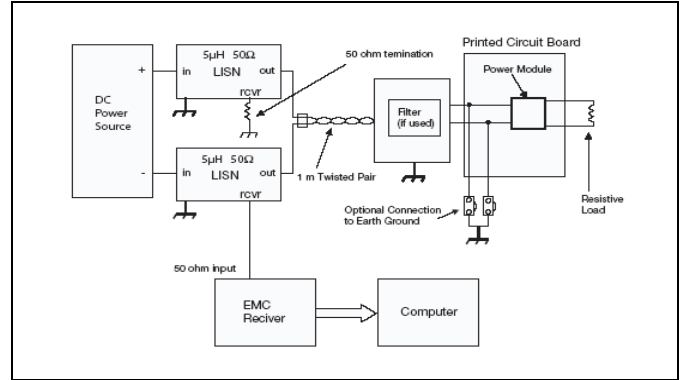

Test set-up

Layout recommendation

The radiated EMI performance of the DC/DC converter will depend on the PCB layout and ground layer design. It is also important to consider the stand-off of the DC/DC converter. If a ground layer is used, it should be connected to the output of the DC/DC converter and the equipment ground or chassis.

A ground layer will increase the stray capacitance in the PCB and improve the high frequency EMC performance.

Output ripple and noise

Output ripple and noise measured according to figure below. See Design Note 022 for detailed information.

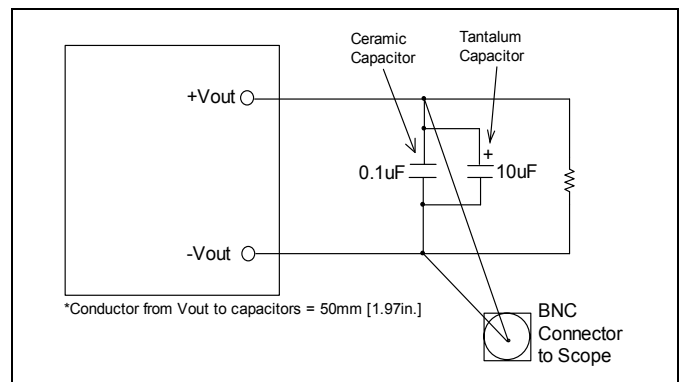

Output ripple and noise test setup

PKM 4000B PI series Intermediate Bus Converters
 Input 36-75 V, Output up to 33 A / 380 W

EN/LZT 146 305 R5C March 2010
 © Ericsson AB

Operating information

Input Voltage

The input voltage range 36 to 75 Vdc meets the requirements of the European Telecom Standard ETS 300 132-2 for normal input voltage range in -48 and -60 Vdc systems, -40.5 to -57.0 V and -50.0 to -72 V respectively. At input voltages exceeding 75 V, the power loss will be higher than at normal input voltage and T_{ref} must be limited to absolute max 115°C. The absolute maximum continuous input voltage is 80 Vdc.

Turn-off Input Voltage

The DC/DC converters monitor the input voltage and will turn on and turn off at predetermined levels. The minimum hysteresis between turn on and turn off input voltage is 1 V.

Remote Control (RC)

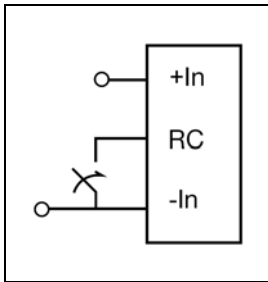

The products are fitted with a remote control function referenced to the primary negative input connection (- In), and positive logic options available. The RC function allows the DC/DC converter to be turned on/off by an external device like a semiconductor or mechanical switch. The RC pin has an internal pull up resistor to + In.

The maximum required sink current is 0.2 mA. When the RC pin is left open, the voltage generated on the RC pin is max 10 V. The second option is "positive logic" remote control, which can be ordered by adding the suffix "P" to the end of the part number. The DC/DC converter will turn on when the RC pin is left open. Turn off is achieved by connecting the RC pin to the - In. To ensure safe turn off the voltage difference between RC pin and the - In pin shall be less than 1V. The DC/DC converter will restart automatically when this connection is opened.

Input and Output Impedance

The impedance of both the input source and the load will interact with the impedance of the DC/DC converter. It is important that the input source has low characteristic impedance. The performance in some applications can be enhanced by addition of external capacitance as described under External Decoupling Capacitors. If the input voltage source contains significant inductance, the addition of a 330 µF capacitor across the input of the DC/DC converter will ensure stable operation.

External Decoupling Capacitors

When powering loads with significant dynamic current requirements, the voltage regulation at the point of load can be improved by addition of decoupling capacitors at the load. The most effective technique is to locate low ESR ceramic and electrolytic capacitors as close to the load as possible, using

several parallel capacitors to lower the effective ESR. The ceramic capacitors will handle high-frequency dynamic load changes while the electrolytic capacitors are used to handle low frequency dynamic load changes. Ceramic capacitors will also reduce any high frequency noise at the load. It is equally important to use low resistance and low inductance PWB layouts and cabling.

For semi-regulated or fixed turns ratio IBC (intermediate bus converters), there is no limit on the value of external output capacitance, but there are practical performance considerations that need to be made when using very large capacitor values such as ramp-up time of the DC/DC converter output voltage during start-up or turn-off discharge considerations. If there are any questions associated with a specific application configuration, please contact your local Ericsson representative for support.

Parallel Operation

The PKM 4000B Series DC/DC converters can be connected in parallel with a common input. Paralleling is accomplished by connecting the output voltage pins and input pins directly. No external components are necessary. Up to 90% of max output current can be used from each module. Layout considerations should be made to avoid unbalanced current sharing. For more details on paralleling, please consult your local Ericsson Power Modules representative.

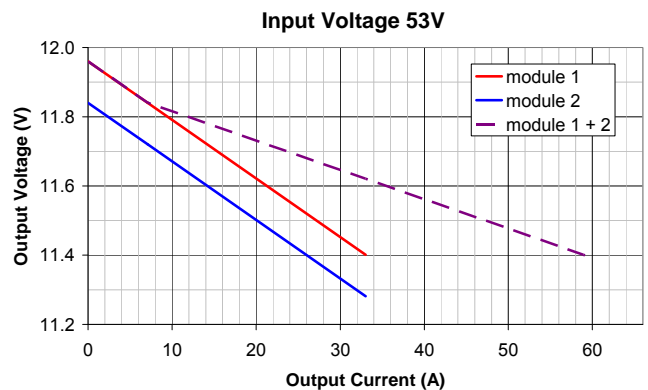

PKM 4000B PI series Intermediate Bus Converters
Input 36-75 V, Output up to 33 A / 380 W

EN/LZT 146 305 R5C March 2010

© Ericsson AB

Over Temperature Protection (OTP)

The DC/DC converters are protected from thermal overload by an internal over temperature shutdown circuit.

When T_{ref} as defined in thermal consideration section exceeds 125°C the DC/DC converter will shut down. The DC/DC converter will make continuous attempts to start up (non latching mode) We provide an optional variant of the product with a latching OTP. Add suffix "LP" to the standard product code to order the latching version. The latching OTP version has a latching OVP as well.

If the OTP/OVP is latched the module can be put in operation either by switching OFF and ON the input voltage or drive OFF and ON the RC (Remote Control) pin.

Over Voltage Protection (OVP)

The DC/DC converters have output over voltage protection that will shut down the DC/DC converter in over voltage conditions. The DC/DC converter will make continuous attempts to start up (non-latching mode) and resume normal operation automatically after removal of the over voltage condition.

Add suffix "LP" to the standard product code to order the latching version. The latching OVP version has a latching OTP as well.

If the OTP/OVP is latched the module can be put in operation either by switching OFF and ON the input voltage or drive OFF and ON the RC (Remote Control) pin.

Over Current Protection (OCP)

The DC/DC converters include current limiting circuitry for protection at continuous overload.

The output voltage will decrease towards zero when the output current exceeds max output current (max I_o).

Under output short circuit, when the output current is in excess of max output current (max I_o), the DC/DC Converter will enter a hiccup mode protection. The DC/DC converter will resume normal operation after removal of the overload or short circuit.

PKM 4000B PI series Intermediate Bus Converters
 Input 36-75 V, Output up to 33 A / 380 W

EN/LZT 146 305 R5C March 2010
 © Ericsson AB

Thermal Consideration

General

The product is designed to operate in various thermal environments and sufficient cooling must be provided to ensure reliable operation. Cooling is achieved mainly by conduction, from the pins to the host board, and convection. The size and copper thickness of the host board will have impact on the Conduction cooling. Convection cooling is dependant on the airflow across the DC/DC converter. Increased airflow enhances the cooling of the DC/DC converter.

The Output Current Derating graph found in the Output section for each model provides the available output current vs. ambient air temperature and air velocity at $V_{in} = 53 V$.

The DC/DC converter is tested on a 254 x 254 mm, 35 μm (1 oz), 16-layer test board mounted vertically in a wind tunnel with a cross-section of 305 x 305 mm.

Proper cooling of the DC/DC converter can be verified by measuring the temperature at reference point. The temperature at these positions should not exceed the max values provided in the table below.

Position	Device	Designation	max value
Reference	PCB	-	125°C

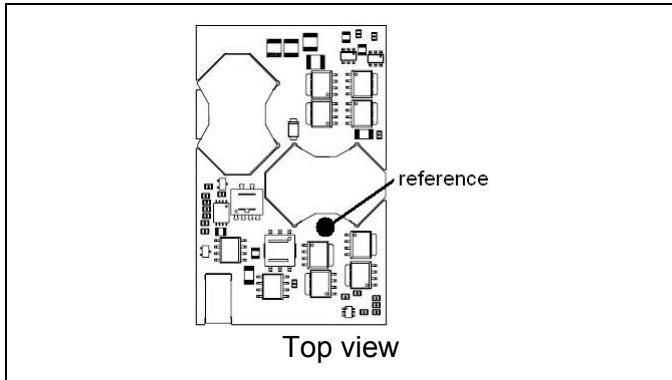

Definition of reference temperature (T_{ref})

The reference temperature is used to monitor the temperature limits of the product. Temperatures above maximum T_{ref} are not allowed and may cause degradation or permanent damage to the product. T_{ref} is also used to define the temperature range for normal operating conditions. T_{ref} is defined by the design and used to guarantee safety margins, proper operation and reliability of the module.

Ambient Temperature Calculation

By using the thermal resistance the estimated maximum allowed ambient temperature can be calculated.

1. The power loss is calculated by using the formula $((1/\eta) - 1) \times \text{output power} = \text{power losses (Pd)}$.
 η = efficiency of converter. E.g 96 % = 0.96
2. Find the thermal resistance (R_{th}) in the Thermal Resistance graph found in the Output section for each model. Calculate the temperature increase (ΔT).
 $T = R_{th} \times P_d$
3. Max allowed ambient temperature is:
 $T_a = \text{Max } T_{ref} - \Delta T$.

E.g. PKM4204B PI at 53Vin 20Aout 1.5 m/s

1. $((1/0.96) - 1) \times 240W = 10 W$
2. $10 W \times 3.5^\circ C = 35^\circ C$
3. $125^\circ C - 35^\circ C = \text{max ambient temperature is } 90^\circ C$

The actual temperature will be dependent on several factors such as the PCB size, number of layers and direction of airflow.

PKM 4000B PI series Intermediate Bus Converters
 Input 36-75 V, Output up to 33 A / 380 W

EN/LZT 146 305 R5C March 2010

© Ericsson AB

Connections

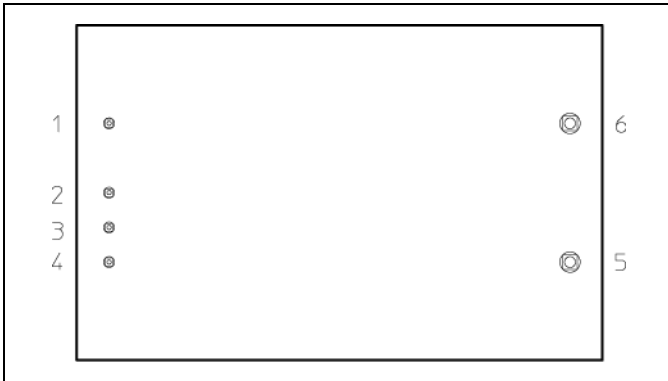

Pin	Designation	Function
1	+In	Positive input
2	RC	Remote control
3	Case	Case to GND (optional)
4	-In	Negative input
5	-Out	Negative output
6	+Out	Positive output

PKM 4000B PI series Intermediate Bus Converters
 Input 36-75 V, Output up to 33 A / 380 W

EN/LZT 146 305 R5C March 2010

© Ericsson AB

Mechanical Information

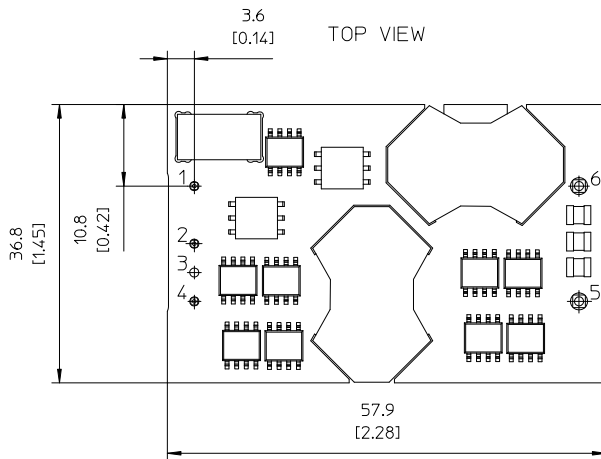
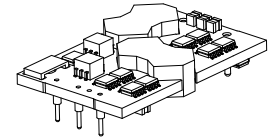
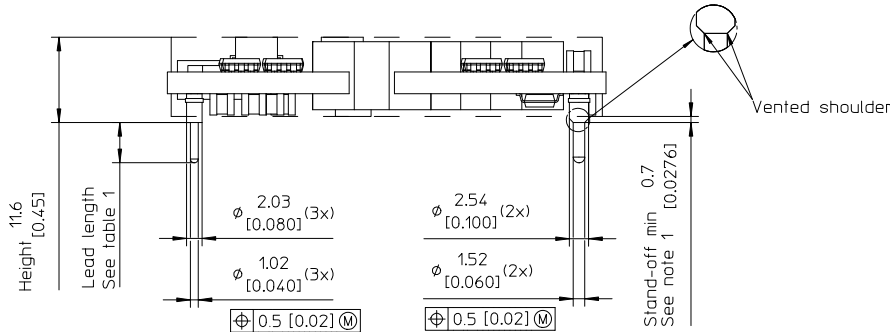

RECOMMENDED FOOTPRINT - TOP VIEW

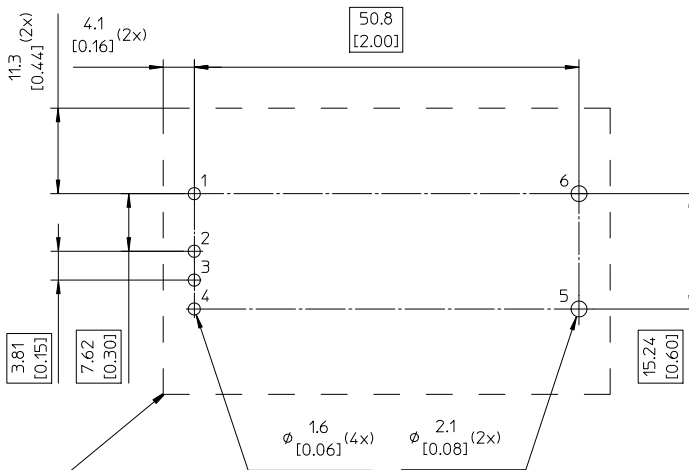

Recommended keep away area for user components.
 The standoff in combination with insulating material ensures that requirements as per IEC/EN/UL60950 are met and 1500 V isolation maintained even if open vias or traces are present under the DC/DC-converter.

Table 1

Pin option	Lead Length
Standard	5.33 [0.210]
LA	3.69 [0.145]
LB	4.57 [0.180]
LC	2.79 [0.110]

Pins:
 Material: Copper alloy
 Plating: 0.1 μm Gold over 2 μm Nickel
 Pin 3 is optional and only used for base plate connection

Notes
 1- Stand off to none conductive components min 0.7 [0.027]
 Stand off to conductive components min 0.95 [0.037]
 For details see safety section page 3.

Weight: Typical 48 g
 All dimensions in mm [inch].
 Tolerances unless specified
 x.x mm ±0.50 [0.02], x.xx mm ±0.25 [0.01]
 (not applied on footprint or typical values)

PKM 4000B PI series Intermediate Bus Converters
 Input 36-75 V, Output up to 33 A / 380 W

EN/LZT 146 305 R5C March 2010

© Ericsson AB

Mechanical Information- Base plate version

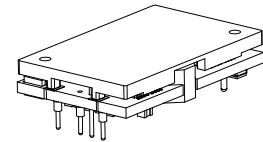
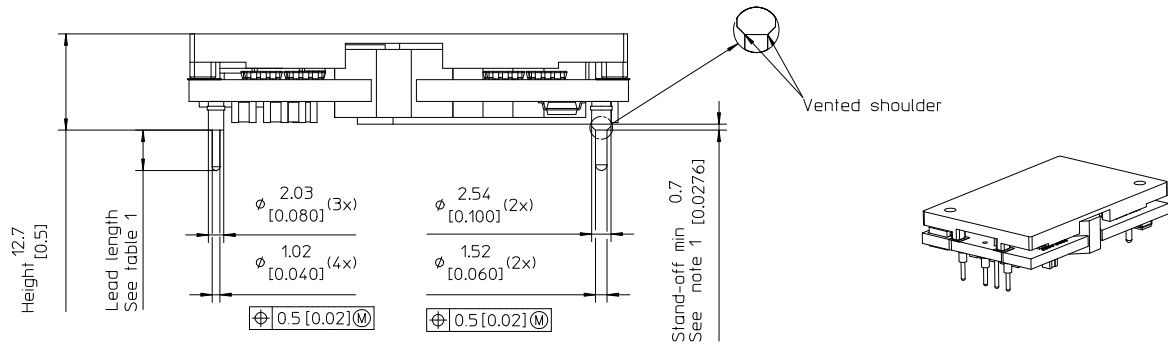

TOP VIEW

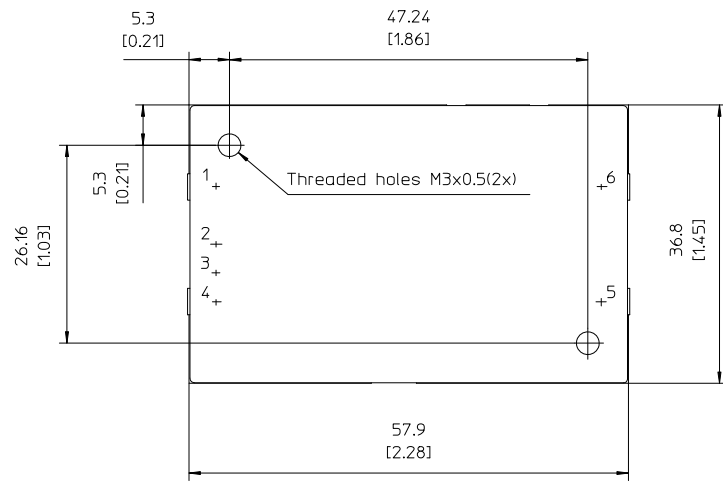

RECOMMENDED FOOTPRINT - TOP VIEW

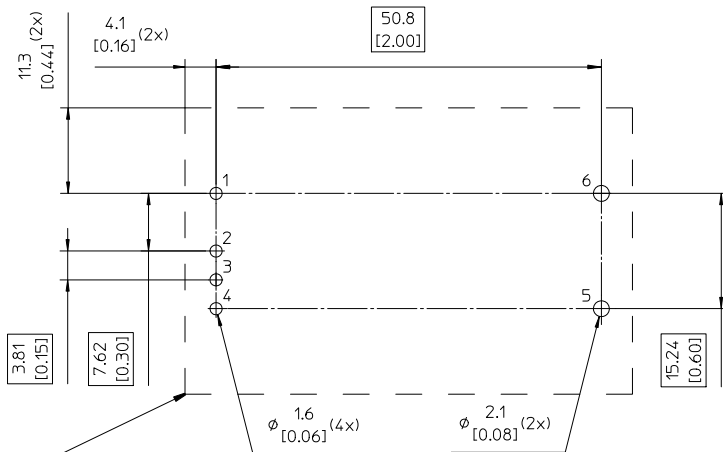

Recommended keep away area for user components.
 The standoff in combination with insulating material ensures that requirements as per IEC/EN/UL60950 are met and 1500 V isolation maintained even if open vias or traces are present under the DC/DC-converter.

Table 1

Pin option	Lead Length
Standard	5.33 [0.210]
LA	3.69 [0.145]
LB	4.57 [0.180]
LC	2.79 [0.110]

Case:

Material: Aluminium

- For screw attachment apply mounting torque of max 0.44 Nm [3.9 lbf in].
- M3 screws must not protrude more than 2.7 [0.106] in to the base plate.

Pins:

Material: Copper alloy

Plating: 0.1 µm Gold over 2 µm Nickel

Pin 3 is optional and only used

for base plate connection

Notes

- 1- Stand off to none conductive components min 0.7 [0.027]
- Stand off to conductive components min 0.95 [0.037]
- For details see safety section page 3.

Weight: Typical 67 g

All dimensions in mm [inch].

Tolerances unless specified

x.x mm ±0.50 [0.02], x.xx mm ±0.25 [0.01]

(not applied on footprint or typical values)



PKM 4000B PI series Intermediate Bus Converters
 Input 36-75 V, Output up to 33 A / 380 W

EN/LZT 146 305 R5C March 2010

© Ericsson AB

Soldering Information – Through Hole Mounting

The product is intended for through hole mounting in a PCB. When wave soldering is used, the temperature on the pins is specified to maximum 260 °C for maximum 10 seconds.

Maximum preheat rate of 4 °C/s and temperature of max 150 °C is suggested. When hands soldering care should be taken to avoid direct contact between the hot soldering iron tip and the pins for more than a few seconds in order to prevent overheating.

A no-clean (NC) flux is recommended to avoid entrapment of cleaning fluids in cavities inside of the DC/DC power module. The residues may affect long time reliability and isolation voltage.

Delivery package information

The products are delivered in antistatic trays.

Tray specifications	
Material	PE foam, dissipative
Surface resistance	10E5 to 10E12 ohms/square
Tray capacity	20 converters/tray
Box capacity	20 converters
Weight	Product - Open frame 1100 g full, 140 g empty Product – Base plate option 1480 g full, 140 g empty

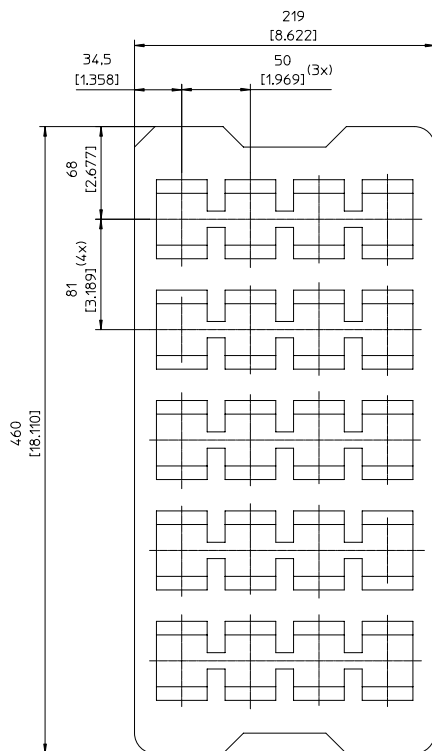

PKM 4000B PI series Intermediate Bus Converters
 Input 36-75 V, Output up to 33 A / 380 W

EN/LZT 146 305 R5C March 2010

© Ericsson AB

Product Qualification Specification

Characteristics			
External visual inspection	IPC-A-610		
Change of temperature (Temperature cycling)	IEC 60068-2-14 Na	Temperature range Number of cycles Dwell/transfer time	-40 to +100°C 1000 15 min/0-1 min
Cold (in operation)	IEC 60068-2-1 Ad	Temperature T _A Duration	-45°C 72 h
Damp heat	IEC 60068-2-67 Cy	Temperature Humidity Duration	+85°C 85 % RH 1000 hours
Dry heat	IEC 60068-2-2 Bd	Temperature Duration	+125°C 1000 h
Immersion in cleaning solvents	IEC 60068-2-45 XA Method 2	Water Glycol ether Isopropyl alcohol	+55 ±5°C +35 ±5°C +35 ±5°C
Mechanical shock	IEC 60068-2-27 Ea	Peak acceleration Duration Pulse shape Directions Number of pulses	100 g 6 ms Half sine 6 18 (3 + 3 in each perpendicular direction)
Operational life test	MIL-STD-202G method 108A with power cycling	T _{ref} Load Duration	125°C Nominal 1000 h
Resistance to soldering heat	IEC 60068-2-20 Tb	Solder temperature Duration	Max 270°C 10-13 s
Robustness of terminations	IEC 60068-2-21 Ua1	Tensile force	20 N for 10 s
Solderability	IEC 60068-2-20 Ta	Preconditioning Temperature, SnPb Eutectic Temperature, Pb free	Steam ageing 1 h ± 5 min 235 ±5°C 260 ±5°C
Vibration, broad band random	IEC 60068-2-64 Fh	Frequency Spectral density Duration	10 to 500 Hz 0.07 g ² /Hz 10 min in each 3 perpendicular directions