



Positronic  
connectpositronic.com

# MILITARY QUALITY FIXED AND REMOVABLE CONTACTS HIGH DENSITY D-SUBMINIATURE

D-Sub

Size 22 Signal and  
Thermocouple Contacts,  
Removable Crimp and  
Printed Board Mount

PosiBand® Closed Entry

MIL-DTL-24308 and SAE AS39029

UL Recognized  
File #E49351

CSA Recognized  
File #LR54219

Telecommunication  
UL File #E140980



Densi-D series connectors are military quality, high density connectors designed for use in sheltered, mildly corrosive environments having a wide range of temperature, pressure and humidity changes. Applicable connectors are qualified to MIL-DTL-24308 and SAE AS39029 (see page 82 for more information).

Densi-D series connectors utilize precision machined contacts with closed barrel crimp terminations, solder cup termi-

nations, straight and right angle (90°) printed board mount. All female contacts utilize Positronic's unique PosiBand closed entry design, see page 1 for details.

Six standard contact variants are offered in arrangements of 15, 26, 44, 62, 78 and 104 contacts. Densi-D series connectors are mateable and compatible with other high density D-subminiature connectors conforming to MIL-DTL-24308.

A wide variety of unique accessories are available.

## DENSI-D SERIES TECHNICAL CHARACTERISTICS

### MATERIALS AND FINISHES:

<b>Insulators:</b>	Glass filled polyester per ASTM D5927, UL 94V-0, blue color.
<b>Contacts:</b>	Precision machined copper alloy.
<b>Contact Plating:</b>	Military performance - 0.000050 inch [1.27 µ] gold over nickel plate. Industrial performance - gold flash over nickel plate. Other finishes available upon request.
<b>Shells:</b>	Steel with tin plate; zinc plate with chromate seal, stainless steel passivated. Other materials and finishes available upon request.
<b>Mounting Spacers:</b>	Nylon; copper alloy or steel with zinc plate and chromate seal or tin plate; phosphor bronze with tin plate; stainless steel, passivated.
<b>Push-On Fastener:</b>	Phosphor bronze or beryllium copper with tin plate.
<b>Vibration Lock Systems:</b>	Slide lock and lock tabs, steel with nickel plate.
<b>Jackscrew Systems:</b>	Brass or steel with zinc plate and chromate seal or clear zinc plate or tin plate; stainless steel, passivated.
<b>Hoods:</b>	Composite and plastic, UL 94V-0; brass or steel with zinc plate and chromate seal. Aluminum; aluminum with electroless nickel plate. For aluminum hoods, zinc content is 1% maximum. Die cast zinc.

Low magnetic versions are available, contact Technical Sales.

### MECHANICAL CHARACTERISTICS:

<b>Removable Contacts:</b>	Insert contact to rear face of insulator and release from rear face of insulator. Size 22 contacts, male - 0.030 inch [0.76mm] mating diameter. Female contacts - PosiBand closed entry design, see page 1 for details.
<b>Contact Retention In Insulator:</b>	9 lbs. [40 N].
<b>Contact Terminations:</b>	Closed barrel crimp, wire sizes 22 AWG

[0.3mm<sup>2</sup>] through 30 AWG [0.05mm<sup>2</sup>] per IEC 352-2.

Right Angle (90°) Printed Board Mount contact terminations.

<b>Shells:</b>	Male shells may be dimpled for EMI/ESD ground paths.
<b>Polarization:</b>	Trapezoidally shaped shells and polarized jackscrews.
<b>Mounting To Angle Brackets:</b>	Jackscrews and riveted fasteners with 0.120 inch [3.05mm] clearance hole, and threaded riveted fasteners with 4-40 threads and polyester lock inserts.
<b>Mounting To Printed Board:</b>	Rapid installation push-on fasteners and mounting posts.
<b>Locking Systems:</b>	Jackscrews and vibration locking systems.
<b>Mechanical Operations:</b>	1000 operations minimum per IEC 60512-5.

### ELECTRICAL CHARACTERISTICS:

#### Contact Current Rating, Tested per UL 1977:

12 amperes, 2 contacts energized.
10 amperes, 6 contacts energized.
7.5 amperes, 26 contacts energized.
6.5 amperes, 62 contacts energized.
5.0 amperes, 104 contacts energized.

See temperature rise curves on page 2 for details.

<b>Initial Contact Resistance:</b>	0.005 ohms maximum.
<b>Proof Voltage:</b>	1000 V r.m.s.
<b>Insulation Resistance:</b>	5 G ohms.
<b>Clearance and Creepage Distance [minimum]:</b>	0.042 inch [1.06mm].
<b>Working Voltage:</b>	300 V r.m.s.

### CLIMATIC CHARACTERISTICS:

<b>Temperature Range:</b>	-55°C to +125°C.
<b>Damp Heat, Steady State:</b>	21 days.

### THERMOCOUPLE CONTACTS:

Size 22 crimp contacts are available, see page 56 for details.

Printed circuit board mount contacts are available, please Consult Accessories D-subminiature catalog for details.



CONTACT VARIANTS

FACE VIEW OF MALE OR REAR VIEW OF FEMALE

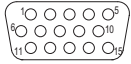

DD 15

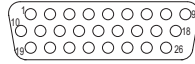

DD 26

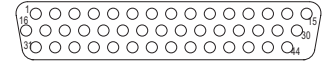

DD 44

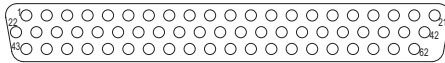

DD 62

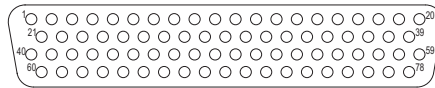

DD 78

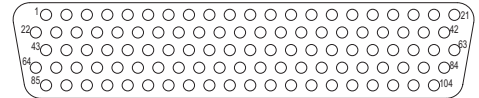

DD 104

STANDARD SHELL ASSEMBLY

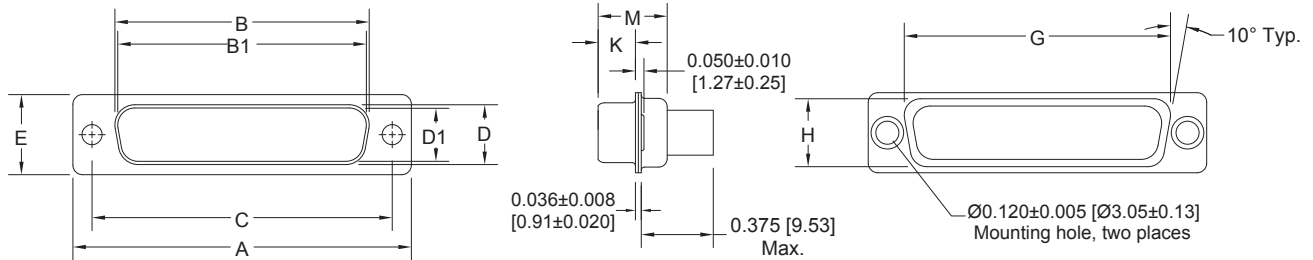

OPTIONAL SHELL ASSEMBLY (0, 02)

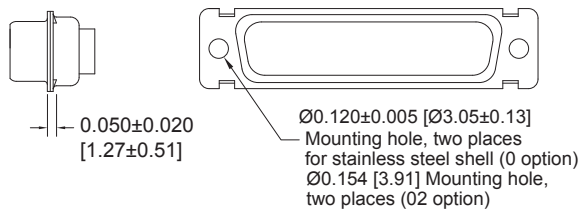

OPTIONAL SHELL ASSEMBLY WITH UNIVERSAL FLOAT MOUNTS (F)

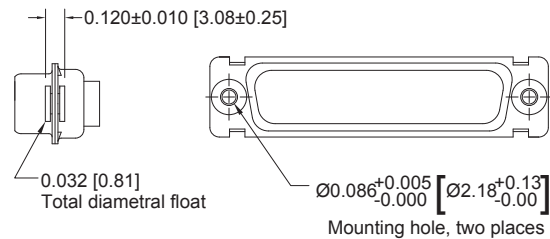

CONNECTOR VARIANT SIZES	A ±0.015 [0.38]	B ±0.005 [0.13]	B1 ±0.005 [0.13]	C ±0.005 [0.13]	D ±0.005 [0.13]	D1 ±0.005 [0.13]	E ±0.015 [0.38]	G ±0.010 [0.25]	H ±0.010 [0.25]	K ±0.005 [0.13]	M ±0.010 [0.25]
DD 15 M	1.213 [30.81]		0.666 [16.92]	0.984 [24.99]		0.329 [8.36]	0.494 [12.55]	0.759 [19.28]	0.422 [10.72]	0.233 [5.92]	0.422 [10.72]
DD 15 S	1.213 [30.81]	0.643 [16.33]		0.984 [24.99]	0.311 [7.90]		0.494 [12.55]	0.759 [19.28]	0.422 [10.72]	0.243 [6.17]	0.429 [10.90]
DD 26 M	1.541 [39.14]		0.994 [25.25]	1.312 [33.32]		0.329 [8.36]	0.494 [12.55]	1.083 [27.51]	0.422 [10.72]	0.233 [5.92]	0.422 [10.72]
DD 26 S	1.541 [39.14]	0.971 [24.66]		1.312 [33.32]	0.311 [7.90]		0.494 [12.55]	1.083 [27.51]	0.422 [10.72]	0.243 [6.17]	0.429 [10.90]
DD 44 M	2.088 [53.04]		1.534 [38.96]	1.852 [47.04]		0.329 [8.36]	0.494 [12.55]	1.625 [41.28]	0.422 [10.72]	0.230 [5.84]	0.426 [10.82]
DD 44 S	2.088 [53.04]	1.511 [38.38]		1.852 [47.04]	0.311 [7.90]		0.494 [12.55]	1.625 [41.28]	0.422 [10.72]	0.243 [6.17]	0.429 [10.90]
DD 62 M	2.729 [69.32]		2.182 [55.42]	2.500 [63.50]		0.329 [8.36]	0.494 [12.55]	2.272 [57.71]	0.422 [10.72]	0.230 [5.84]	0.426 [10.82]
DD 62 S	2.729 [69.32]	2.159 [54.84]		2.500 [63.50]	0.311 [7.90]		0.494 [12.55]	2.272 [57.71]	0.422 [10.72]	0.243 [6.17]	0.429 [10.90]
DD 78 M	2.635 [66.93]		2.079 [52.81]	2.406 [61.11]		0.441 [11.20]	0.605 [15.37]	2.178 [55.32]	0.534 [13.56]	0.230 [5.84]	0.426 [10.82]
DD 78 S	2.635 [66.93]	2.064 [52.43]		2.406 [61.11]	0.423 [10.74]		0.605 [15.37]	2.178 [55.32]	0.534 [13.56]	0.243 [6.17]	0.429 [10.90]
DD 104 M	2.729 [69.32]		2.212 [56.18]	2.500 [63.50]		0.503 [12.78]	0.668 [16.97]	2.302 [58.47]	0.596 [15.14]	0.230 [5.84]	0.426 [10.82]
DD 104 S	2.729 [69.32]	2.189 [55.60]		2.500 [63.50]	0.485 [12.32]		0.668 [16.97]	2.302 [58.47]	0.596 [15.14]	0.243 [6.17]	0.429 [10.90]



Positronic  
connectpositronic.com

# MILITARY QUALITY FIXED AND REMOVABLE CONTACTS HIGH DENSITY D-SUBMINIATURE

D-Sub

## REMOVABLE CRIMP CONTACT

CODE 1

CONTACTS MAY BE SUPPLIED WITH CONNECTOR OR ORDERED SEPARATELY.

QUALIFIED TO SAE AS39029

### \*MILITARY SPECIFICATION CONTACTS

**STANDARD FINISH:**  
per SAE AS39029 specifications

**COLOR CODE:**

**MALE CONTACT:**  
ORANGE/BLUE/BLACK

**FEMALE CONTACT:**  
ORANGE/GREEN/YELLOW

Note: Connectors can be kitted with all applicable crimp/solder contacts, contact Technical Sales for connector part number.

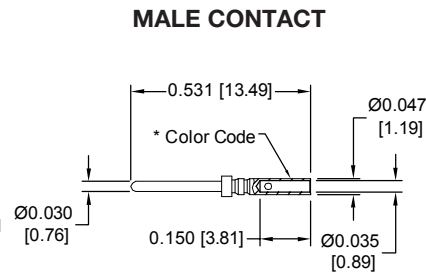
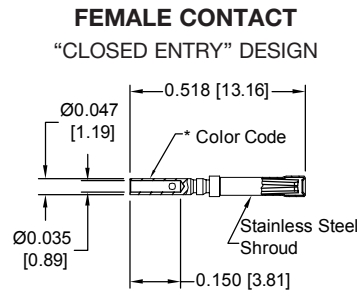

FEMALE PART NUMBER	WIRE SIZE AWG/[mm <sup>2</sup> ]
*M39029/57-354	22 / 24 / 26 / 28 [0.3/0.25/0.12/0.08]
Positronic is qualified to supply the legacy design, as well as, the PosiBand design. If the requirement is for the PosiBand design exclusively, notify sales at time of quotation for order placement when requesting M39029 contacts.	

MALE PART NUMBER	WIRE SIZE AWG/[mm <sup>2</sup> ]
*M39029/58-360	22 / 24 / 26 / 28 [0.3/0.25/0.12/0.08]

## REMOVABLE CRIMP CONTACT

CODE 1

CONTACTS MAY BE SUPPLIED WITH CONNECTOR OR ORDERED SEPARATELY.



Authentic POSITRONIC

PosiBand®

These contacts utilize authentic Positronic PosiBand® technology.  
Protected by U.S. Patent 7,115,002

Note: Connectors can be kitted with all applicable crimp/solder contacts, contact Technical Sales for connector part number.

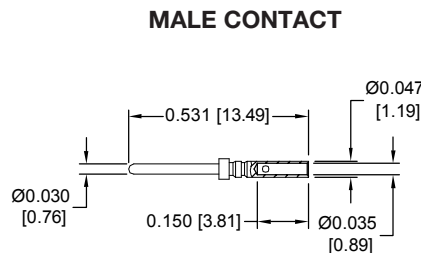
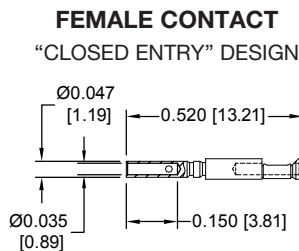

FEMALE PART NUMBER	WIRE SIZE AWG/[mm <sup>2</sup> ]
FC8022D2	22 / 24 / 26 / 28 / 30 [0.3/0.25/0.12/0.08/0.05]

MALE PART NUMBER	WIRE SIZE AWG/[mm <sup>2</sup> ]
MC8022D	22 / 24 / 26 / 28 / 30 [0.3/0.25/0.12/0.08/0.05]

**PLATING:**

**STANDARD FINISH:** Gold flash over nickel plate.

**OPTIONAL FINISHES:** 0.000030 [0.76] gold over nickel by adding "-14" suffix onto part number. Example: FC8022D2-14

0.000050 inch [1.27] gold over nickel by adding "-15" suffix onto part number. Example: MC8022D-15

For information regarding **CRIMP TOOLS & CRIMPING TOOL TECHNIQUES**, see page 78.



Authentic POSITRONIC  
**PosiBand**

These contacts utilize authentic Positronic PosiBand technology.  
Protected by U.S. Patent 7,115,002

**REMOVABLE CRIMP CONTACT**  
**20 AWG CONTACTS**  
20 AWG [0.5 mm<sup>2</sup>]

The crimp area of this contact is not protected when fully seated in the connector molding. These contacts require shrink tubing after installation. Wire cannot be removed from molding after insertion. Not suitable for fully loaded connector.

CONTACTS MAY BE SUPPLIED WITH CONNECTOR OR ORDERED SEPARATELY.

**Note: FC8020D2 and MC8020D contacts can be used in the ODD series.**

*Note: Connectors can be kitted with all applicable crimp/solder contacts, contact Technical Sales for connector part number.*

**FEMALE CONTACT**  
"CLOSED ENTRY" DESIGN

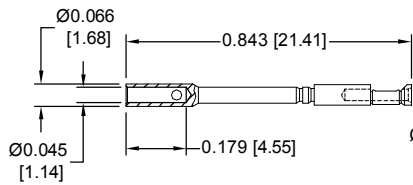

**MALE CONTACT**

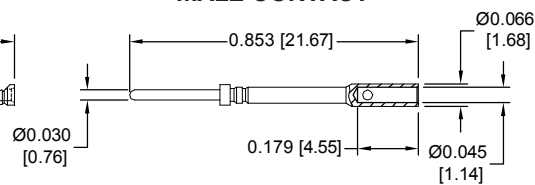

Crimp area extends above connector molding.

FEMALE PART NUMBER	WIRE SIZE AWG/[mm <sup>2</sup> ]
FC8020D2	20 [0.5] max

MALE PART NUMBER	WIRE SIZE AWG/[mm <sup>2</sup> ]
MC8020D	20 [0.5] max

**PLATING:**

**STANDARD FINISH:** Gold flash over nickel plate.

**OPTIONAL FINISHES:** 0.000030 [0.76] gold over nickel by adding "-14" suffix onto part number. Example: FC8020D2-14  
0.000050 inch [1.27] gold over nickel by adding "-15" suffix onto part number. Example: MC8020D-15

**REMOVABLE THERMOCOUPLE CRIMP CONTACT**

CONTACTS MAY BE SUPPLIED WITH CONNECTOR OR ORDERED SEPARATELY.

*Note: Connectors can be kitted with all applicable crimp/solder contacts, contact Technical Sales for connector part number.*



Authentic POSITRONIC  
**PosiBand**

These contacts utilize authentic Positronic PosiBand technology.  
Protected by U.S. Patent 7,115,002

**FEMALE CONTACT**  
"CLOSED ENTRY" DESIGN

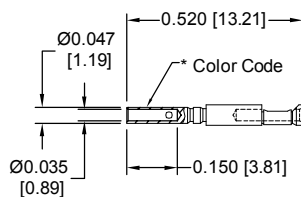

**MALE CONTACT**

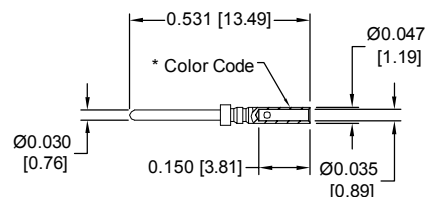

TYPE	MATERIAL	FEMALE PART NUMBER	MALE PART NUMBER	COLOR CODE*	WIRE SIZE AWG [mm <sup>2</sup> ]
K	CHROMEL (+)	FC8022D2CH	MC8022DCH	WHITE	22 / 24 / 26 [ 0.3 / 0.25 / 0.12 ]
	ALUMEL (-)	FC8022D2AL	MC8022DAL	GREEN	22 / 24 / 26 [ 0.3 / 0.25 / 0.12 ]
T	COPPER (+)	FC8022D2CU	MC8022DCU	RED	22 / 24 / 26 [ 0.3 / 0.25 / 0.12 ]
	CONSTANTAN (-)	FC8022D2CO	MC8022DCO	YELLOW	22 / 24 / 26 [ 0.3 / 0.25 / 0.12 ]
E	CHROMEL (+)	FC8022D2CH	MC8022DCH	WHITE	22 / 24 / 26 [ 0.3 / 0.25 / 0.12 ]
	CONSTANTAN (-)	FC8022D2CO	MC8022DCO	YELLOW	22 / 24 / 26 [ 0.3 / 0.25 / 0.12 ]

For more information on the availability of Type J thermocouple contacts, please contact Technical Sales.

For more information about thermocouple contacts with printed circuit board solder termination, please contact Technical Sales.

Chromel® and Alumel® are registered trademarks of Hoskins Manufacturing Company

For information regarding **CRIMP TOOLS & CRIMPING TOOL TECHNIQUES**, see page 78.



Positronic  
connectpositronic.com

# MILITARY QUALITY FIXED AND REMOVABLE CONTACTS HIGH DENSITY D-SUBMINIATURE

D-Sub

## REMOVABLE SOLDER CUP CONTACTS CODE 2

CONTACTS MAY BE SUPPLIED WITH CONNECTOR OR ORDERED SEPARATELY.



Note: Connectors can be kitted with all applicable crimp/solder contacts, contact Technical Sales for connector part number.

### FEMALE CONTACT "CLOSED ENTRY" DESIGN

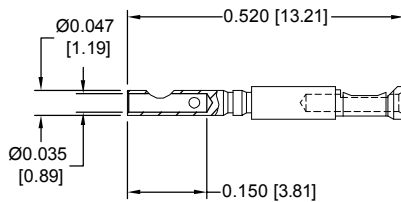

FEMALE PART NUMBER	WIRE SIZE AWG/[mm <sup>2</sup> ]
FS8022D2	22 [0.3] max

### MALE CONTACT

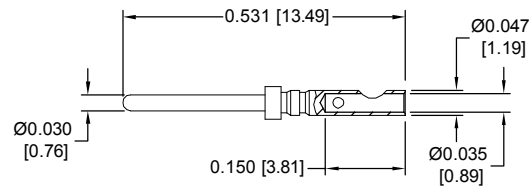

MALE PART NUMBER	WIRE SIZE AWG/[mm <sup>2</sup> ]
MS8022D	22 [0.3]max

#### PLATING:

**STANDARD FINISH:** Gold flash over nickel plate.

**OPTIONAL FINISHES:** 0.000030 [0.76] gold over nickel by adding "-14" suffix onto part number. Example: FS8022D2-14  
0.000050 inch [1.27] gold over nickel by adding "-15" suffix onto part number. Example: MS8022D-15

For information regarding *INSERTION & REMOVAL TOOLS*, see page 78.

## STRAIGHT PRINTED BOARD MOUNT TERMINATION

CODE 3, 32 AND 33

CODE NUMBER	L
3	0.150 [3.81]
32	0.300 [7.62]
33	0.500 [12.70]

For straight printed board mount contacts specify code no. in step 4 of ordering information.

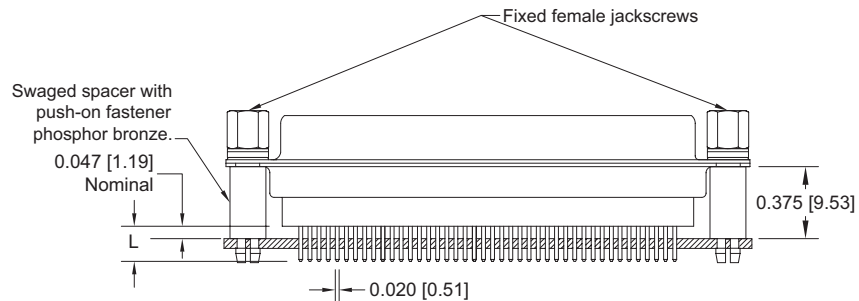

Typical Part Number: DD62S3S60T2X

DD SERIES



**RIGHT ANGLE (90°) PRINTED BOARD MOUNT TERMINATION**  
CODE 4, 0.450 [11.43] CONTACT EXTENSION

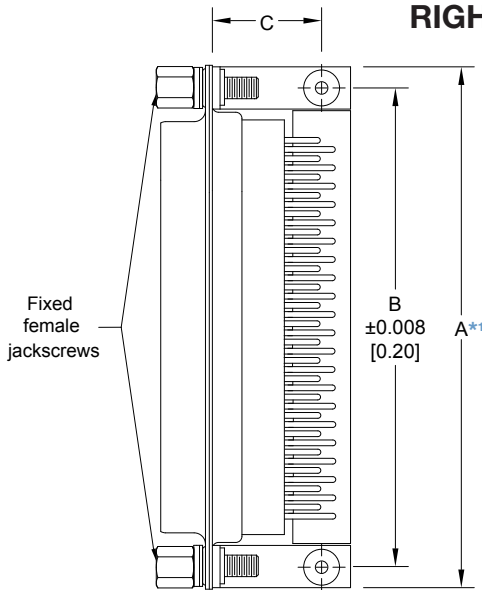

DD**4*** 0.450 [11.43] CONTACT EXTENSION				
PART NUMBER	A*1	B	C	D
DD15*4***	1.204 [30.58]	0.984 [24.99]	0.528 [13.41]	0.450 [11.43]
DD26*4***	1.532 [38.91]	1.312 [33.32]	0.528 [13.41]	0.450 [11.43]
DD44*4***	2.072 [52.63]	1.852 [47.04]	0.528 [13.41]	0.450 [11.43]
DD62*4***	2.720 [69.09]	2.500 [63.50]	0.528 [13.41]	0.450 [11.43]
DD78*4***	2.626 [66.70]	2.406 [61.11]	0.573 [14.55]	0.450 [11.43]

**NOTE:**

\*1 "A" dimension applies for metal angle brackets only. Consult Accessories D-subminiature catalog for "A" dimension when plastic brackets are used.

Specify code 4 in step 4 of ordering information

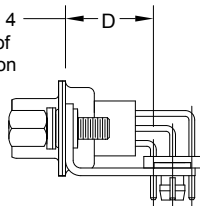

Typical Part Number:  
DD44M4R7NT2X

0.078 [1.98] Typ.  
0.078 [1.98] Typ.

Numbering shown is rear view of male and face view of female.

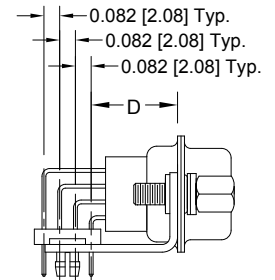
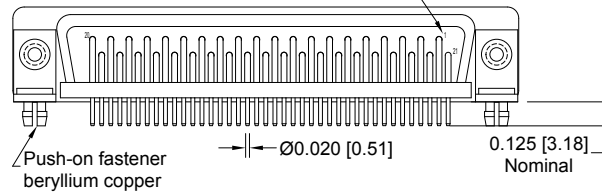

Typical Part Number:  
DD78M4R7NT2X

**RIGHT ANGLE (90°) PRINTED BOARD MOUNT TERMINATION, SIZE 104**  
CODE 4, 0.450 [11.43] CONTACT EXTENSION

**NOTE:**

\*1 Dimension applies for metal angle brackets only. Consult Accessories D-subminiature catalog for dimension when plastic brackets are used.

Typical Part Number: DD104M4R7NT20

Specify code 4 in step 4 of ordering information

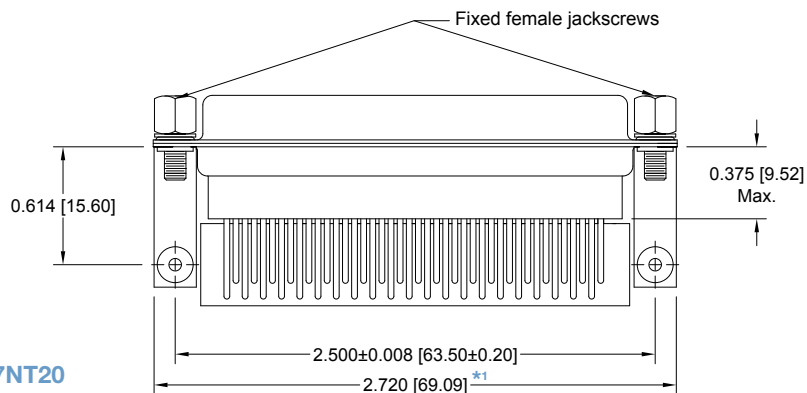
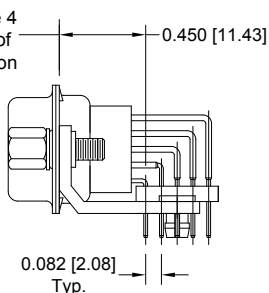

Numbering shown is rear view of male and face view of female

Push-on fastener beryllium copper

0.125 [3.17] Nominal  
Ø0.020 [0.51]

DIMENSIONS ARE IN INCHES [MILLIMETERS].  
ALL DIMENSIONS ARE SUBJECT TO CHANGE.



**RIGHT ANGLE (90°) AND STRAIGHT PRINTED BOARD CONTACT HOLE PATTERN**  
MOUNT CONNECTOR WITH MATING FACE POSITIONED TO FOLLOW DIRECTION OF ARROWS.

**DD15 MALE**

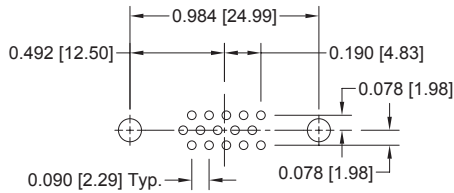

**DD15 FEMALE**

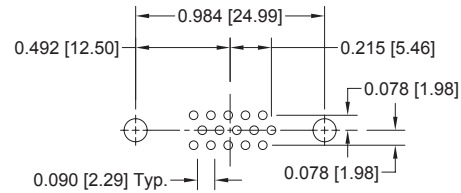

**DD 26 MALE**

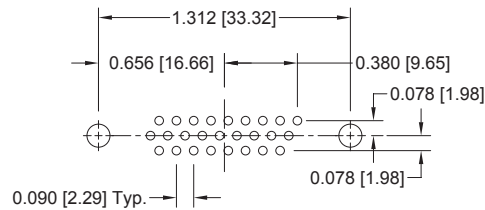

**DD 26 FEMALE**

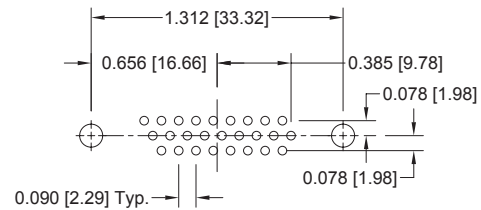

**DD44 MALE**

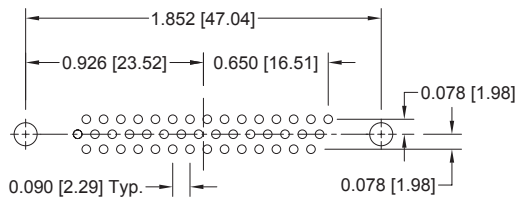

**DD44 FEMALE**

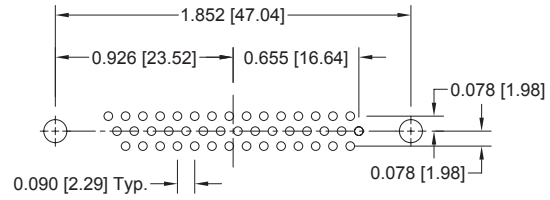

**DD62 MALE**

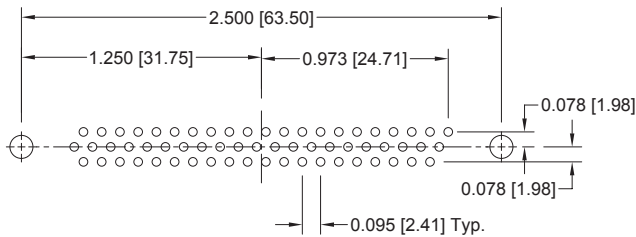

**DD62 FEMALE**

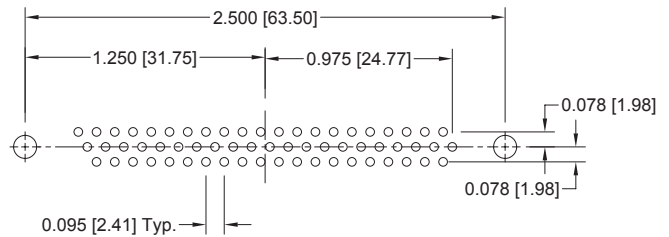

**DD78 MALE**

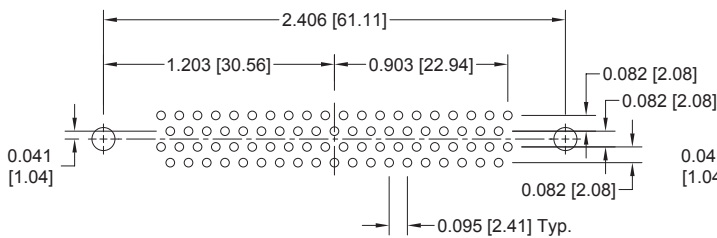

**DD78 FEMALE**

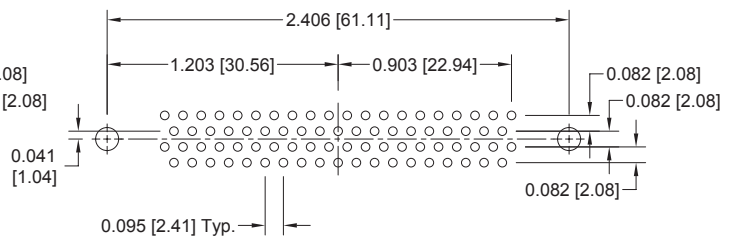

**DD104 MALE**

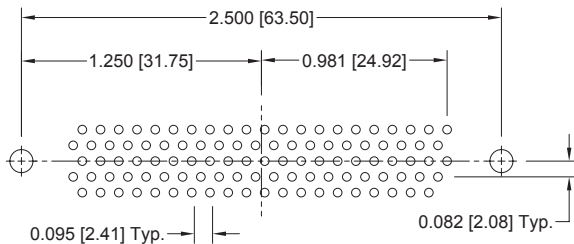

**DD104 FEMALE**

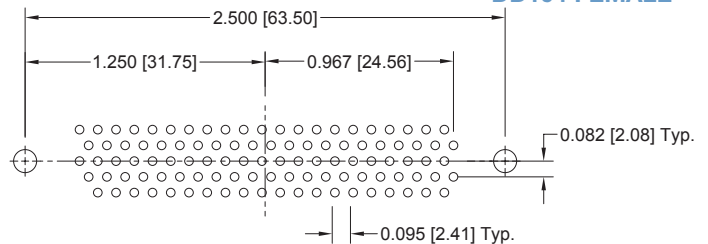

**SUGGESTED PRINTED BOARD HOLE SIZES:**

Suggest 0.035 [0.89] Ø hole for contact termination positions.

Suggest 0.123 ±0.003 [3.12 ±0.08] Ø hole for mounting connector with push-on fasteners.



## ORDERING INFORMATION - CODE NUMBERING SYSTEM

Specify Complete Connector By Selecting An Option From Step 1 Through 8

STEP	1	2	3	4	5	6	7	8	9	10
EXAMPLE	DD	62	S	4	R7	N	T6	S	/AA	-50
<b>STEP 1 - BASIC SERIES</b> DD series										<b>STEP 10 - SPECIAL OPTIONS</b> -14 - 0.000030 [0.76µ] gold over nickel. -15 - 0.000050 [1.27µ] gold over nickel. -50 - 0.000050 [1.27µ] gold over copper. <b>CONTACT TECHNICAL SALES FOR ORDERING DETAILS OF THE FOLLOWING:</b> Other Special Requirements. Straight and Right Angle (90°) Thermocouple printed circuit board mount contacts
<b>STEP 2 - CONNECTOR VARIANTS</b> 15, 26, 44, 62, 78, 104										<b>STEP 9 - ENVIRONMENTAL COMPLIANCE OPTIONS</b> /AA - RoHS Compliant  <b>NOTE:</b> If compliance to environmental legislation is not required, this step will not be used. Example: DD62S4R7NT6S
<b>STEP 3 - CONNECTOR GENDER</b> M - Male S - Female - PosiBand closed entry contacts										<b>STEP 8 - SHELL OPTIONS</b> 0 - Zinc plated with chromate seal. *S - Stainless steel, passivated. X - Tin plated. Z - Tin plated and dimpled (male connectors only). C - Cadmium with chromate seal.
<b>STEP 4 - CONTACT TERMINATION TYPE</b> 0 - Contacts ordered separately, see pages 55-57. 1 - Crimp, 22 AWG-30 AWG [0.3mm <sup>2</sup> -0.05mm <sup>2</sup> ]. 2 - Removable, Solder cup, 22 AWG-30 AWG [0.3mm <sup>2</sup> -0.05mm <sup>2</sup> ]. 3 - Solder, Straight Printed Board Mount with 0.150 [3.81] Tail Length. 32 - Solder, Straight Printed Board Mount with 0.300 [7.62] Tail Length. 33 - Solder, Straight Printed Board Mount with 0.500 [12.70] Tail Length. 4 - Solder, Right Angle (90°) Printed Board Mount with 0.450 [11.43] Contact Extension.										<b>*1 STEP 7 - LOCKING AND POLARIZING SYSTEMS</b> 0 - None. *3 V3 - Lock Tab, connector front panel mounted. *3 V5 - Lock Tab, connector rear panel mounted. *3 VL - Lock Lever, used with Hoods only. T - Fixed Female Jackscrews. T2 - Fixed Female Jackscrews. T6 - Fixed Male and Female Polarized Jackscrews. E - Rotating Male Jackscrews. E2 - Rotating Male Screw Locks. E3 - Rotating Male with internal hex for 3/32 hex drives E6 - Rotating Male and Female Polarized Jackscrews.
<b>*1 STEP 5 - MOUNTING STYLE</b> 0 - Mounting Hole, 0.120 [3.05] Ø. 02 - Mounting Hole, 0.154 [3.91] Ø. B3 - Bracket, Mounting, Right Angle (90°) Metal with Cross Bar. B8 - Bracket, Mounting, Right Angle (90°) Plastic with Cross Bar. F - Float Mounts, Universal. P - Threaded Post, Brass, 0.375 [9.53] Length. P2 - Threaded Post, Nylon, 0.375 [9.53] Length. R2 - Bracket, Mounting, Right Angle (90°) Metal, Swaged to Connector with 4-40 Thread Fixed Female Jackscrews with Cross Bar. R6 - Bracket, Mounting, Right Angle (90°) Metal, Swaged to Connector with 0.120 [3.05] Ø Mounting Hole with Cross Bar. R7 - Bracket, Mounting, Right Angle (90°) Metal, Swaged to Connector with 4-40 Threads with Cross Bar. R8 - Bracket, Mounting, Right Angle (90°) Metal, Swaged to Connector with 4-40 Locknut with Cross Bar. S - Swaged Spacer, 4-40 Threads, 0.375 [9.53] Length. S2 - Swaged Spacer, 4-40 Threads, 0.125 [3.18] Length. S5 - Swaged Locknut, 4-40 Threads. S6 - Swaged Spacer with Push-on Fasteners, 4-40 Threads, 0.375 [9.53] Length. S7 - Swaged Spacer with Push-on Fastener for use with Ferrite Inductor, 4-40 Threads, 0.515 [13.08] Length.										<b>*1 STEP 6 - HOODS AND PUSH-ON FASTENERS</b> 0 - None. J - Hood, Top Opening, Plastic. L - Hood, Side Opening, Plastic. Y - Hood, Top Opening, Plastic with Rotating Male Jackscrews. Available in size 78 and 104 only. Y6 - Hood, Top Opening, Plastic with Rotating Male and Female Polarized Jackscrews. Available in size 78 and 104 only. Z - Hood, Top or Side Opening, Robust and Extended Height, Composite and Plastic with Rotating Male Jackscrews. Available in size 15, 26, 44, 62, and 78 only. H - Hood, Top Opening, Metal. Available in size 26, 44, 62, and 78 only. G - Hood, EMI/RFI, Die Cast Zinc. AN - Lightweight Aluminum Hood, nickel finish. AC - Lightweight Aluminum Hood, no finish. W - Hood, Top or Side Opening, Plastic. Available in size 15, 26, and 44 only. N - Push-on Fastener, for Right Angle (90°) Mounting Brackets. *2F - Ferrite Inductor
<b>*1 For additional information on accessories listed in steps 5, 6 and 7, see Accessory Catalog.</b> <b>*2 Ferrite inductor is available on contact types 32 and 33 only. For more information on ferrite inductors, see page 7.</b> <b>*3 VL, V3 and V5 locking systems are not available for connector variants 62, 78 and 104. Jackscrews are highly recommended to minimize damage to contacts on variants with high mating forces.</b> <b>*4 For stainless steel dimpled male versions contact Technical Sales.</b>										

For information regarding **CRIMP TOOLS & CRIMPING TOOL TECHNIQUES**, see page 78.