

LINEAR

L-OA28
 μ AF111, μ AF211, μ AF311,
 μ A111, μ A211, μ A311

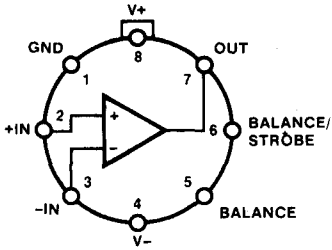

Metal Can and Mini-Dip
 Connection Shown

L-OA29
 μ AF111, μ AF211, μ AF311,
 μ A111, μ A211, μ A311

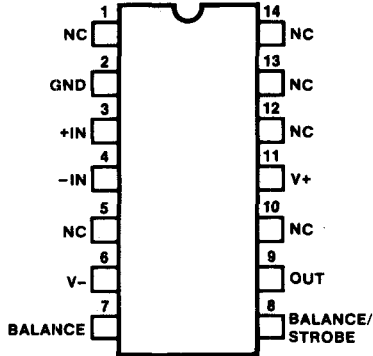

L-OA30
 μ A139/A, μ A239/A, μ A339/A,
 μ A775, μ A2901, μ A7302

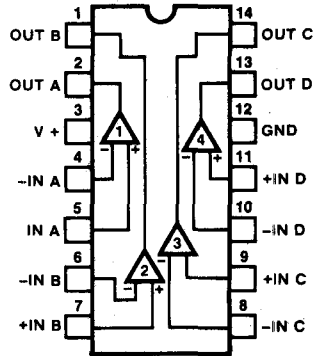

L-OA31
 μ A710

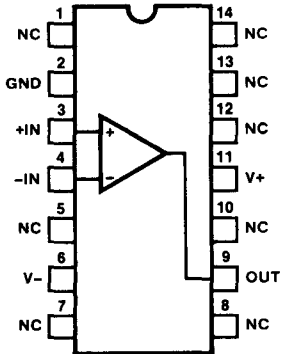

L-OA32
 μ A710

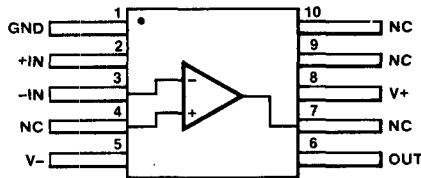

L-OA33
 μ A710

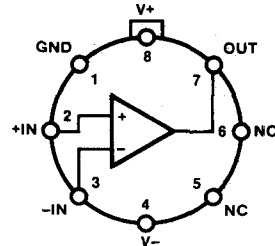

L-OA34
 μ A711

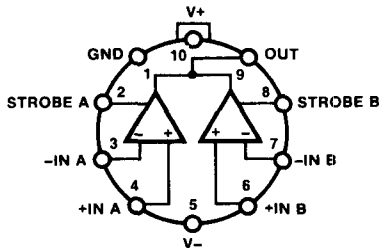

L-OA35
 μ A711

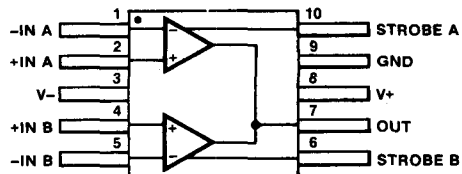

FAIRCHILD LINEAR

OPERATIONAL AMPLIFIERS

VOLTAGE COMPARATORS (Cont'd)

Item	DEVICE NO.	Description	Input Bias Current ⁽¹⁾ μA (Max)	Input Offset Current ⁽¹⁾ μA (Max)	Input Offset Voltage ⁽¹⁾	Voltage Gain (Typ)
1	μA111	Voltage Comparator (Strobed Inputs, Single Supply, Low I _B)	0.1	0.04	0.7	200K
2	μA211	Voltage Comparator (Strobed Inputs, Single Supply, Low I _B)	0.1	0.04	0.7	200K
3	μA311	Voltage Comparator (Strobed Inputs, Single Supply, Low I _B)	0.25	0.06	2.0	200K
4	μA139	Quad Comparator (Single Supply, MRR incl. gnd)	0.1	0.025	5.0	200K
5	μA139A	Quad Comparator (Single Supply, MRR incl. gnd)	0.1	0.025	2.0	200K
6	μA239	Quad Comparator (Single Supply, MRR incl. gnd)	0.25	0.05	5.0	200K
7	μA239A	Quad Comparator (Single Supply, MRR incl. gnd)	0.25	0.05	2.0	200K
8	μA339	Quad Comparator (Single Supply, MRR incl. gnd)	0.25	0.05	5.0	200K
9	μA339A	Quad Comparator (Single Supply, MRR incl. gnd)	0.25	0.05	2.0	200K
10	μA710	Voltage Comparator	20/25	3.0/5.0	2.0/5.0	1.75K
11	μA711	Dual Comparator	75/100	10/15	3.5/5.0	1.5K
12	μA734	Precision Comparator (Low Drift -3.5μV/°C)	0.15	0.025/0.05	5.0/3.0	25K
13	μA760	High Speed Differential Comparator	60	7.5	6.0	5K
14	μA775	Quad Comparator (Single Supply, MRR incl. gnd)	0.3	0.07	9.0	200K
15	μA2901	Quad Comparator (Single Supply, MRR incl. gnd)	0.25	0.05	7.0	200K
16	μA7302	Quad Comparator (Single Supply, MRR incl. gnd)	0.1	0.03	5.0	200K

1. Measured at T_A = 25°C

2. Response time is specified for 100 mV step input with 5.0 mV overdrive.

3. M = Military temperature range, -55°C to +125°C; A = Automotive temperature range, -40°C to +85°C;

C = Commercial temperature range, 0°C to +70°C.

FAIRCHILD LINEAR

Supply Voltage V (Typ)	Response Time ⁽²⁾ ns (Typ)	DTL/TTL Fanout	Temperature Range ⁽³⁾	Logic/Connection Diagram	Package(s)
0, +5 to ±15	200	5	M	L-OA28,29	TO-99, 6T
0, +5 to ±15	200	5	A	L-OA28,29	TO-99, 6T
0, +5 to ±15	200	5	C	L-OA28,29	TO-99, 6T
±1 to ±18, gnd to +2 or gnd to +36	1300	1	M	L-OA30	6A
±1 to ±18, gnd to +2 or gnd to +36	1300	1	M	L-OA30	6A
±1 to ±18, gnd to +2 or gnd to +36	1300	1	A	L-OA30	6A, 9A
±1 to ±18, gnd to +2 or gnd to +36	1300	1	A	L-OA30	6A, 9A
±1 to ±18, gnd to +2 or gnd to +36	1300	1	C	L-OA30	6A, 9A
±1 to ±18, gnd to +2 or gnd to +36	1300	1	C	L-OA30	6A
+12, -6	40	1	M, C	L-OA31, 32, 33	TO-99, 3F, 6A, 9A
+12, -6	40	1	M, C	L-OA34, 35, 36	TO-100, 3F, 6A, 9A
±5 to ±15	200	2	M, C	L-OA37, 38	TO-100, 6A
±4.5 to ±6.5	25	2	M, C	L-OA39, 40	TO-99, 6A
±1 to ±18, gnd to +2 or gnd to +36	1300	1	M, C	L-OA30	6A, 9A
±1 to ±18, gnd to +2 or gnd to +36	1300	1	A	L-OA30	9A
±1 to ±18, gnd to +2 or gnd to +36	1300	1	C	L-OA30	6A, 9A

7