

φ3-31

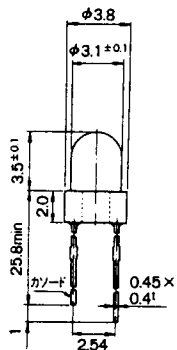

φ3-32

一般公差 ±0.2
リードセンターズル ±0.4
単位: mm

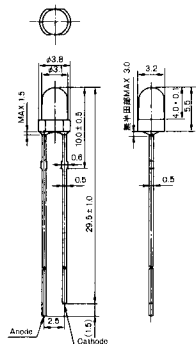

φ3-33

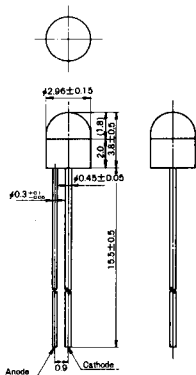

φ3-34

一般公差 ±0.2
リードセンターズル ±0.4
単位: mm

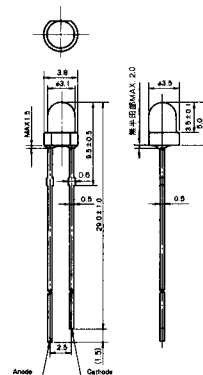

φ3-35

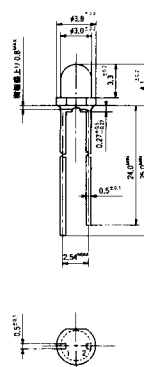

1. Anode
2. Cathode

φ3-36

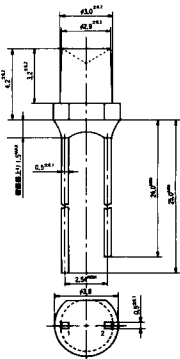

1. Anode
2. Cathode

φ3-37

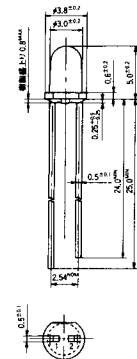

1. Anode
2. Cathode

φ3-38

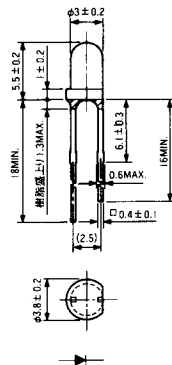

φ3-39

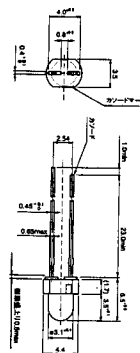

φ3-40

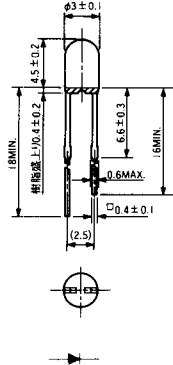

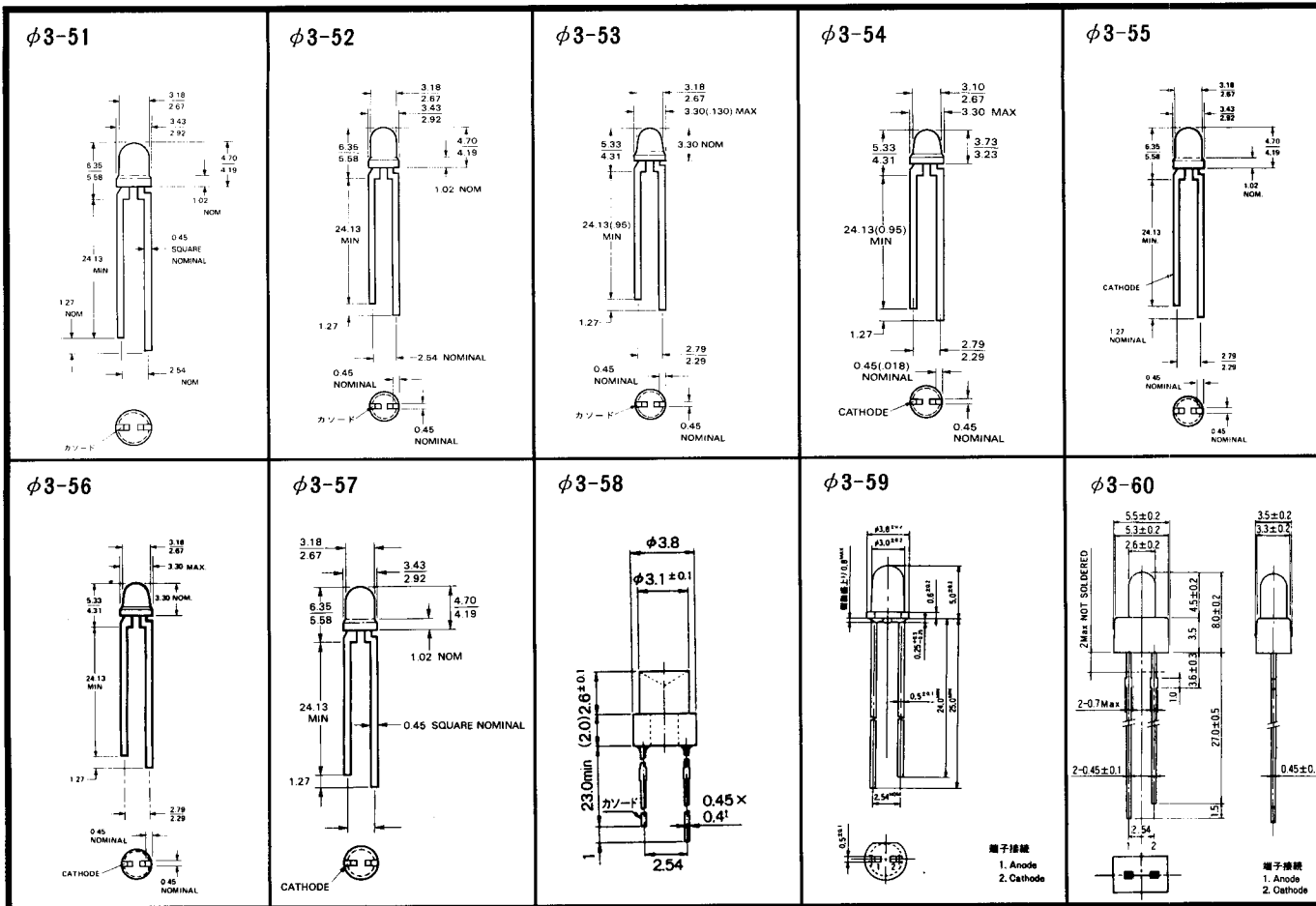

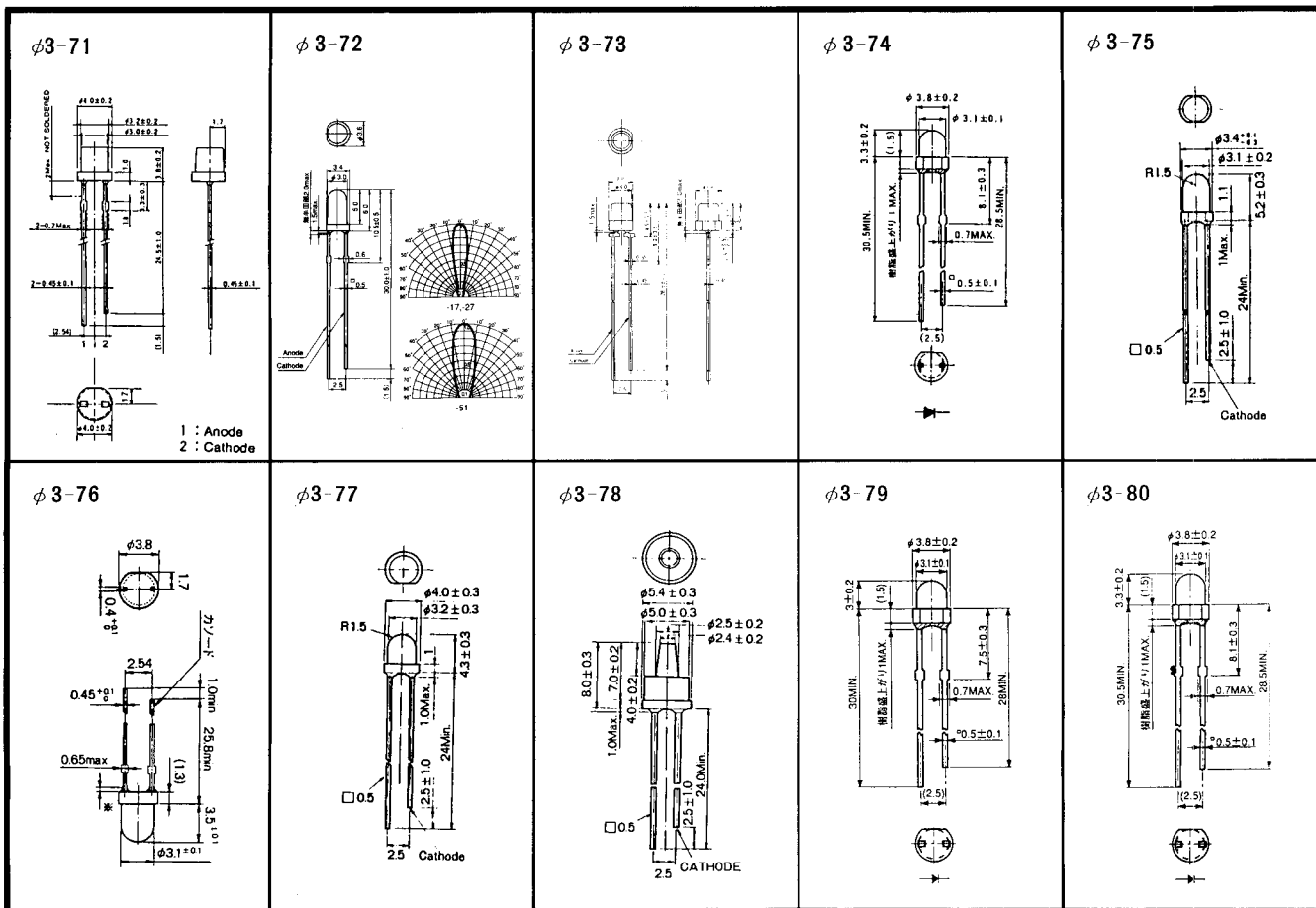

φ3-81

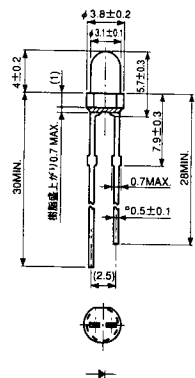

φ3-82

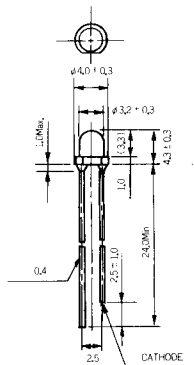

φ3-83

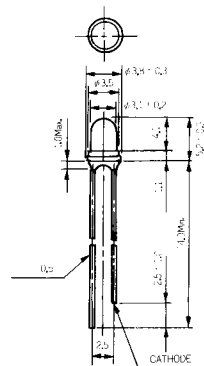

φ3-84

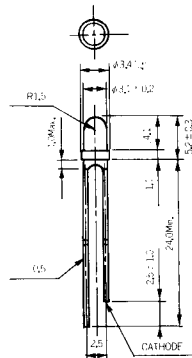

φ3-85

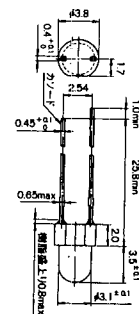

φ3-86

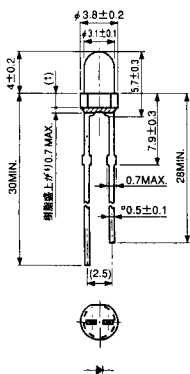

φ3-87

φ3-88

φ3-89

φ3-90

