

PACKAGE DIMENSIONS

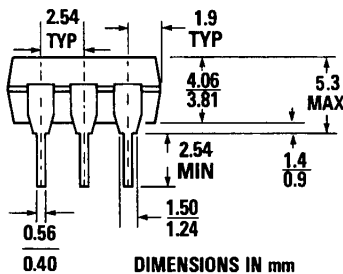

ST1603A

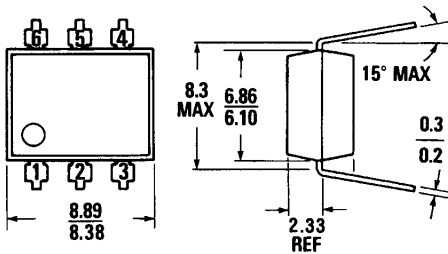
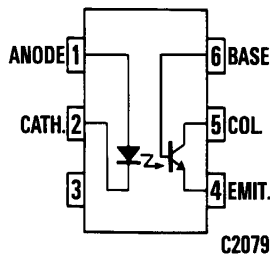

Equivalent Circuit

DESCRIPTION

The MCT520X are high performance logic compatible phototransistor type optically coupled isolator products. They are constructed using a very low degradation and high-efficiency AlGaAs, 890 nm infrared emitter, coupled to a high speed NPN phototransistor, in a six-pin dual-in-line package. They provide a very high current transfer ratio (CTR), high switching speed and 5300 VAC RMS withstand test voltage performance. The critical circuit design parameters of CTR_{CE} and CTR_{CB} are guaranteed over a temperature range of 0-70°C resulting in guaranteed switching propagation delays when interfaced to LSTTL logic.

The MCT5201 has a minimum saturated CTR of 120% for a LED input current of 5 mA. Maximum LSTTL interface propagation delays of 30 μ s are guaranteed with the use of an external 330K resistor between the base and emitter. The MCT5200 is specified for a minimum saturated CTR of 75% for an input current of 10 mA.

FEATURES

- High $CTR_{CE(SAT)}$ comparable to Darlington
- Guaranteed switching speed with LSTTL load
- Performance guaranteed over 0°C to 70°C
- High common mode rejection—5 kV/ μ s
- Data rates up to 150 kbits/s (NRZ)
- Underwriters Laboratory (UL) recognized file #E90700

APPLICATIONS

- LSTTL digital logic isolation
- IEEE 488 isolated inputs
- Switching power supply
- High speed industrial interfaces
- Isolated microprocessor inputs

ABSOLUTE MAXIMUM RATINGS

TOTAL PACKAGE	
Storage temperature	-55°C to 150°C
Operating temperature	-55°C to 100°C
Lead temperature (soldering, 10 sec)	260°C
Total package, power dissipation (LED plus detector)	260 mW
Derate linearly from 25°C	3.5 mW/°C

INPUT DIODE	
Forward DC current	40 mA
Reverse voltage	6 V
Peak forward current (1 μ s pulse, 300 pps)	1.0 A
Power dissipation	54 mW
Derate linearly from 25°C	0.7 mW/°C

OUTPUT TRANSISTOR	
Power dissipation	200 mW
Derate linearly from 25°C	2.67 mW/°C



HIGH-PERFORMANCE AlGaAs PHOTOTRANSISTOR OPTOCOUPLEDERS

INDIVIDUAL COMPONENT CHARACTERISTICS ($T_A=25^\circ\text{C}$ Unless Otherwise Specified)								
CHARACTERISTIC	SYMBOL	MIN.	TYP.	MAX.	UNITS	TEST CONDITIONS	FIG.	NOTE
INPUT DIODE								
Forward voltage	V_F		1.3	1.5	V	$I_F=5\text{ mA}$	1	
Forward voltage coefficient	$\Delta V_F/\Delta T_A$		-1.9		mV/°C	$I_F=2\text{ mA}$	1	
Reverse voltage	V_R	6			V	$I_R=10\ \mu\text{A}$		
Junction capacitance	C_J		18		pF	$V_F=0\text{ V}, f=1\text{ MHz}$ $V_F=1\text{ V}, f=1\text{ MHz}$		
			112					
OUTPUT TRANSISTOR								
DC forward current gain	$h_{FE(SAT)}$		400	—		$V_{CE}=0.4\text{ V},$ $I_{CE}=6\text{ mA}$	8,9	
Breakdown voltage								
Collector to emitter	BV_{CEO}	30	45		V	$I_C=1.0\text{ mA}, I_F=0$		
Collector to base	BV_{CBO}	30	70		V	$I_C=10\ \mu\text{A}, I_F=0$		
Emitter to base	BV_{EBO}	5	7		V	$I_E=10\ \mu\text{A}$		
Leakage								
Collector to emitter	I_{CER}		5	100	nA	$V_{CE}=10\text{ V}, I_F=0,$ $R_{BE}=1\text{ M}\Omega$	11	
Capacitance								
Collector to emitter	C		8		pF	$V_{CE}=0, f=1\text{ MHz}$		
Collector to base			20		pF	$V_{CB}=5, f=1\text{ MHz}$	12	
Emitter to base			7		pF	$V_{EB}=0, f=1\text{ MHz}$		

TRANSFER CHARACTERISTICS (Over Recommended Temperature, $T_A=0^\circ\text{C}$ to 70°C Unless Otherwise Specified)									
DC CHARACTERISTICS	SYMBOL	DEVICE	MIN.	TYP.*	MAX.	UNITS	TEST CONDITIONS	FIG.	NOTE
Saturated current transfer ratio (collector to emitter)	$CTR_{CE(SAT)}$	MCT5200	75	150		%	$I_F=10\text{ mA}, V_{CE}=0.4\text{ V}$	2, 3, 4	1
		MCT5201	120	225		%	$I_F=5.0\text{ mA}, V_{CE}=0.4\text{ V}$	2, 3, 5	
Current transfer ratio (collector to emitter)	CTR_{CE}	MCT5200		200		%	$I_F=10\text{ mA}, V_{CE}=5.0\text{ V}$		1
		MCT5201		300		%	$I_F=5\text{ mA}, V_{CE}=5.0\text{ V}$		
Current transfer ratio (collector to base)	CTR_{CB}	MCT5200	0.2	0.3		%	$I_F=10\text{ mA}, V_{CB}=4.3\text{ V}$		2
		MCT5201	0.28	0.5		%	$I_F=5.0\text{ mA}, V_{CB}=4.3\text{ V}$	6,7	
Saturation voltage (collector to emitter)	$V_{CE(SAT)}$	MCT5200		0.2	0.4	V	$I_F=10\text{ mA}, I_{CE}=7.5\text{ mA}$		
		MCT5201		0.2	0.4	V	$I_F=5\text{ mA}, I_{CE}=6\text{ mA}$		

*All typicals $T_A=25^\circ\text{C}$



HIGH-PERFORMANCE AlGaAs PHOTOTRANSISTOR OPTOCOUPLEDERS

SWITCHING CHARACTERISTICS (Over Recommended Temperature, $T_A=0^\circ\text{C}$ to 70°C Unless Otherwise Specified)							
AC CHARACTERISTICS	SYMBOL	MIN.	TYP.*	MAX.	UNITS	TEST CONDITIONS	FIG. NOTE
MCT-5200							
Delay time	t_d		3	7	μS		
Rise time	t_r		2	6	μS	$I_f=10\text{ mA}$, $V_{CE}=0.4\text{ V}$ $R_L=1.0\text{ K}$, $R_{BE}=330\text{ K}$ $V_{CC}=5.0\text{ V}$	15,18 3,4 5,6
Storage time	t_s		12	18	μS		
Fall time	t_f		17	30	μS		
Propagation delay H→L	t_{PHL}	μS	5	12	μS	$I_f=10\text{ mA}$, $V_{CE}=0.4\text{ V}$ $V_{CC}=5.0\text{ V}$, $R_L=(\text{Fig. 18})$ $R_{BE}=330\text{ K}$	7
Propagation delay L→H	t_{PLH}	μS	13	20	μS		
MCT-5201							
Delay time	t_d		7	15	μS		
Rise time	t_r		6	20	μS	$I_f=5\text{ mA}$, $V_{CE}=0.4\text{ V}$ $R_L=1.0\text{ K}$, $R_{BE}=330\text{ K}$ $V_{CC}=5.0\text{ V}$	13,18 3,4 5,6
Storage time	t_s		8	13	μS		
Fall time	t_f		19	30	μS		
Propagation delay H→L	t_{PHL}		12	30	μS	$I_f=5\text{ mA}$, $V_{CE}=0.4\text{ V}$ $V_{CC}=5.0\text{ V}$, $R_L=(\text{Fig. 18})$ $R_{BE}=330\text{ K}$	7
Propagation delay L→H	t_{PLH}		8	13	μS		

*All typicals $T_A=25^\circ\text{C}$

ISOLATION CHARACTERISTICS ($T_A=25^\circ\text{C}$ Unless Otherwise Specified)							
CHARACTERISTICS	SYMBOL	MIN.	TYP.	MAX.	UNITS	TEST CONDITIONS	FIG. NOTE
Common mode rejection—output high	CM_H		5000		$\text{V}/\mu\text{S}$	$V_{CM}=50\text{ V}_{p-p}$ $R_L=1\text{ K}\Omega$, $I_f=0$	17
Common mode rejection—output low	CM_L		5000		$\text{V}/\mu\text{S}$	$V_{CM}=50\text{ V}_{p-p}$ $R_L=1\text{ K}\Omega$, $I_f=5\text{ mA}$	
Common mode coupling capacitor	C_{cm}		0.2		pF		8
Package capacitance input/output	C_{i-o}		0.7		pF	$V_{i-o}=0$, $f=1\text{ MHz}$	9
Withstand insulation test voltage	V_{ISO}	5300			$V_{AC(RMS)}$	$I_{i-o}\leq 1\text{ }\mu\text{A}$, 1 minute	10 8
	V_{ISO}	7500			$V_{AC(Peak)}$	$I_{i-o}\leq 1\text{ }\mu\text{A}$, 1 minute	10 8
Insulation resistance	R_{ISO}	10^{11}			Ohms	$V_{i-o}=500\text{ V}$	

NOTES

1. DC current transfer ratio (CTR_{DC}) is defined as the transistor collector current (I_{CE}) divided by input LED current (I_f) $\times 100\%$, at a specified voltage collector to emitter (V_{CE}).
2. Current transfer ratio is defined as the collector to base photocurrent (I_{CB}) divided by the input LED current (I_f) times 100%.
3. Switching delay time (t_d) is measured for 50% of LED current to 90% falling edge of V_o .
4. Rise time (t_r) is measured from the 90% to 10% of V_o falling edge.
5. Storage time (t_s) is measured from 50% of falling edge of LED current to 10% of rise edge of V_o .
6. Fall time (t_f) is measured from the 10% to 90% of the rising edge of V_o .
7. The t_{PLH} propagation delay is measured from 50% point on the falling edge of the input pulse to the 1.3 V point on the rising edge of the output pulse. The t_{PHL} propagation delay is measured from 50% point on the rising edge of input to 1.3 V point on falling edge of output pulse.
8. Device considered a two terminal device: Pins 1, 2, and 3 are shorted together. Pins 4, 5, and 6 are shorted together.

TYPICAL ELECTRO-OPTICAL CHARACTERISTICS ($T_A = 25^\circ\text{C}$ Unless Otherwise Specified)

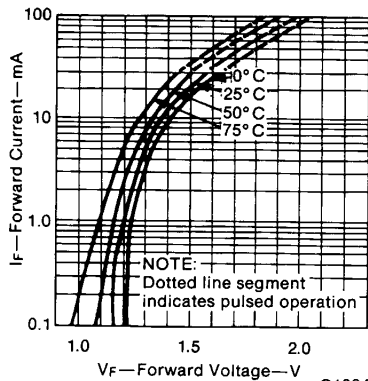

Fig. 1. Forward Voltage vs. Forward Current

C1804

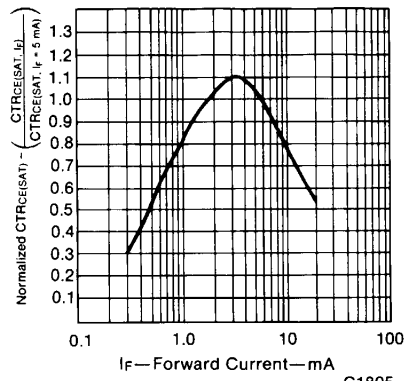

Fig. 2. Normalized Current Transfer Ratio vs. Forward Current

C1805

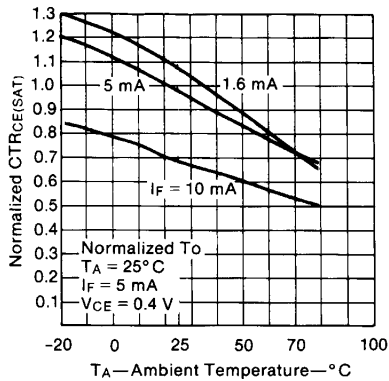

Fig. 3. Normalized CTR vs. Temperature

C1806

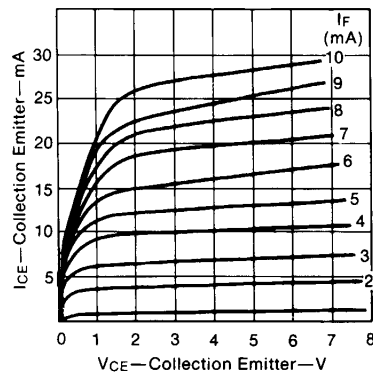

Fig. 4. MCT5200 Collector Current vs. Collector to Emitter Voltage

C1807

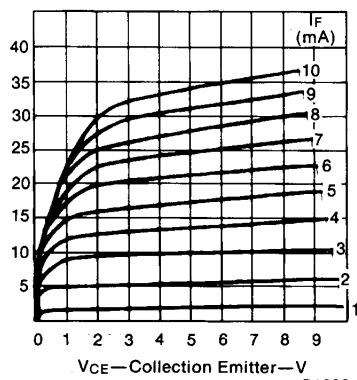

Fig. 5. MCT5201 Collector Current vs. Collector to Emitter Voltage

C1808

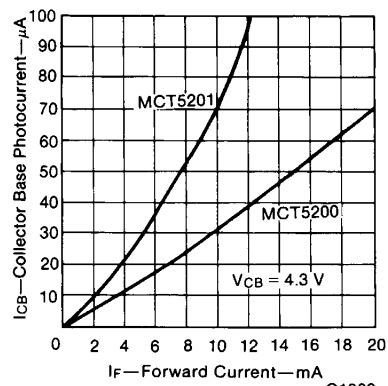

Fig. 6. Collector Base Photocurrent vs. Forward Current

C1809

TYPICAL ELECTRO-OPTICAL CHARACTERISTICS

($T_A=25^\circ\text{C}$ Unless Otherwise Specified) (Cont'd)

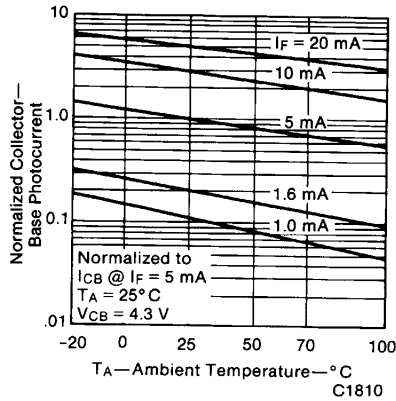

Fig. 7. Normalized Collector Base Photocurrent vs. Ambient Temperature

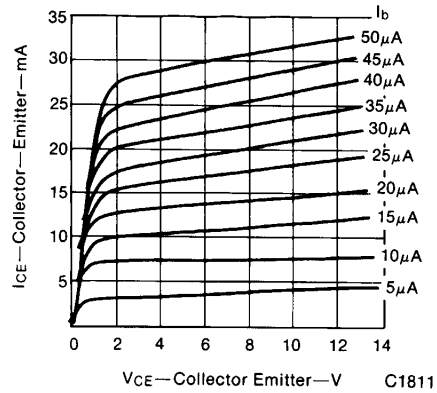

Fig. 8. Collector Current vs. Collector to Emitter Voltage

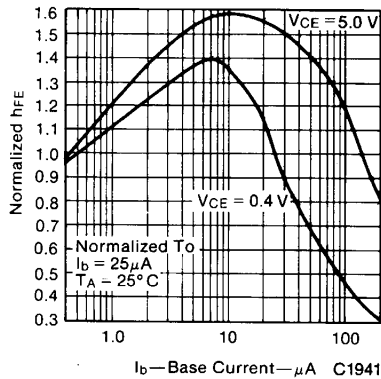

Fig. 9. Normalized h_{FE} vs. Base Current

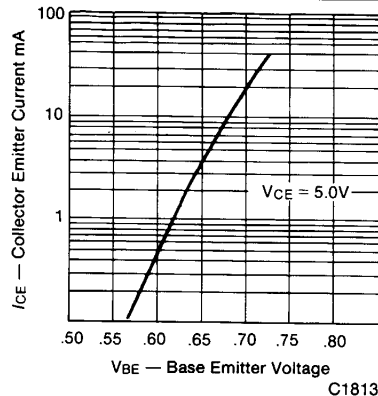

Fig. 10. Collector Current (I_{CE}) vs. Base Emitter Voltage (V_{BE})

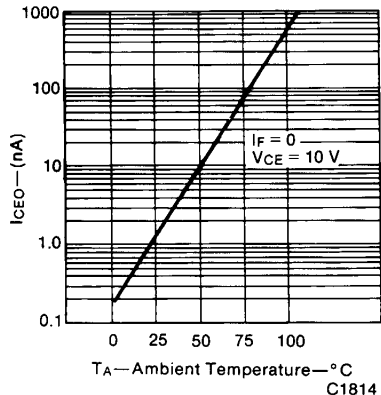

Fig. 11. Collector to Emitter Leakage Current vs. Temperature

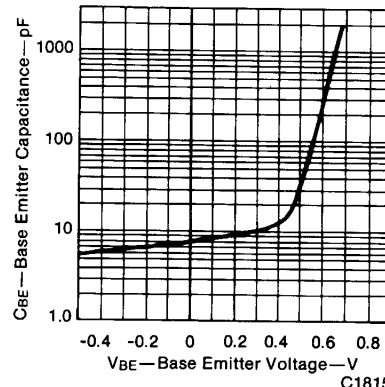

Fig. 12. Base Emitter Capacitance vs. Base Emitter Voltage

TYPICAL ELECTRO-OPTICAL CHARACTERISTICS

($T_A = 25^\circ\text{C}$ Unless Otherwise Specified) (Cont'd)

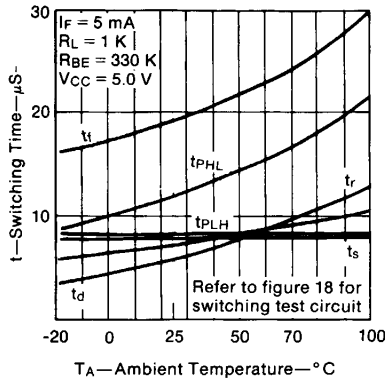

Fig. 13. Switching Time vs. Temperature
 $I_F = 5 \text{ mA } R_{BE} = 330 \text{ K}$

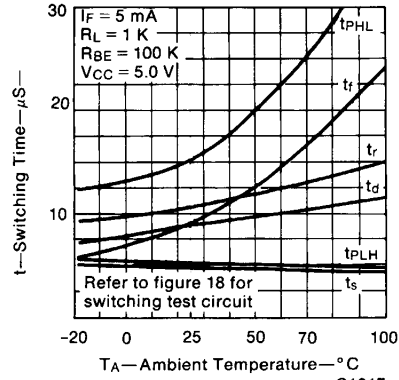

Fig. 14. Switching Speed vs. Temperature
 $I_F = 5 \text{ mA } R_{BE} = 100 \text{ K}$

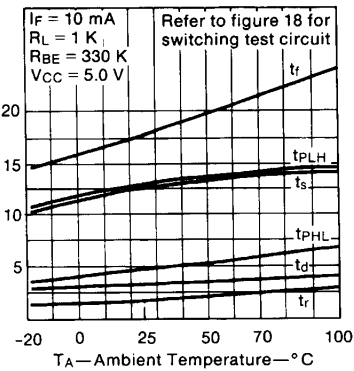

Fig. 15. Switching Speed vs. Temperature
 $I_F = 10 \text{ mA } R_{BE} = 330 \text{ K}$

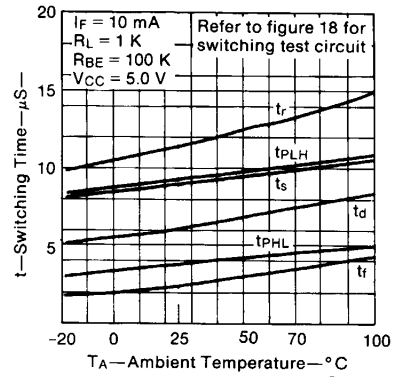

Fig. 16. Switching Speed vs. Temperature
 $I_F = 10 \text{ mA } R_{BE} = 100 \text{ K}$

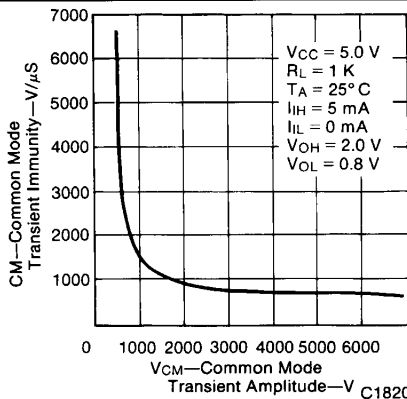

Fig. 17. Common Mode Transient Rejection vs. Common Mode Transient Voltage

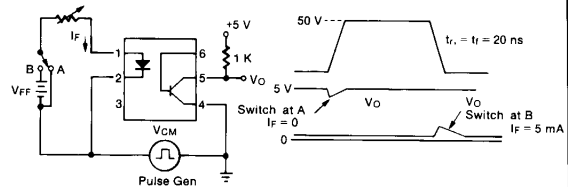
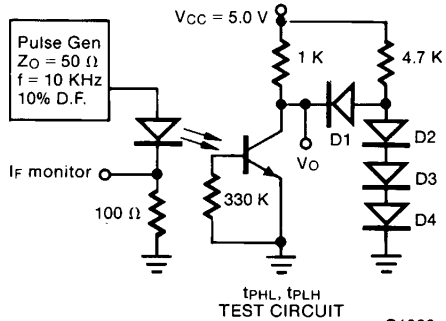
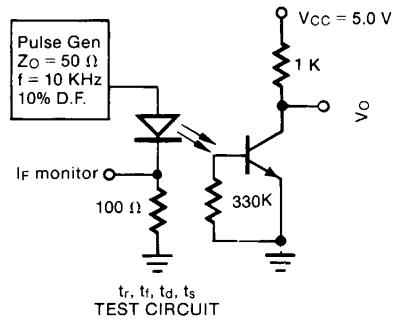

Fig. 18. Text Circuit for Transient Immunity and Typical Waveforms

TYPICAL ELECTRO-OPTICAL CHARACTERISTICS

($T_A = 25^\circ\text{C}$ Unless Otherwise Specified) (Cont'd)



C1822

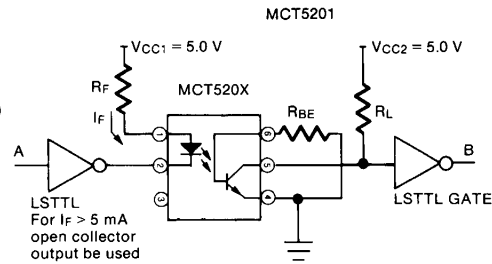
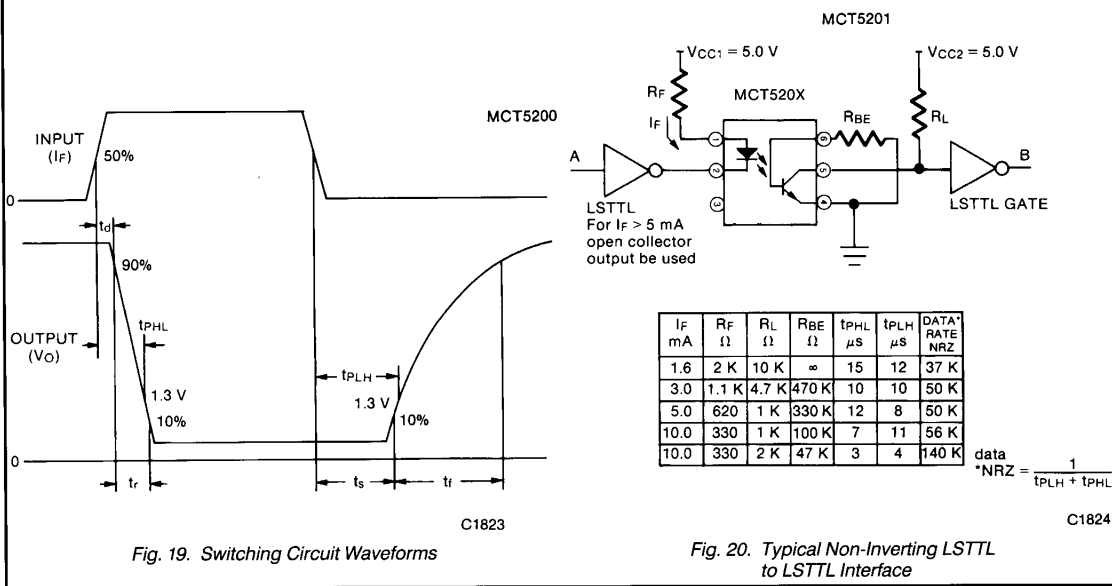

I_F mA	R_F Ω	R_L Ω	R_{BE} Ω	t_{PHL} μs	t_{PLH} μs	DATA RATE NRZ
1.6	2 K	10 K	∞	15	12	37 K
3.0	1.1 K	4.7 K	470 K	10	10	50 K
5.0	620	1 K	330 K	12	8	50 K
10.0	330	1 K	100 K	7	11	56 K
10.0	330	2 K	47 K	3	4	140 K

data
*NRZ = $\frac{1}{t_{PLH} + t_{PHL}}$

C1824

**Fig. 20. Typical Non-Inverting LSTTL
to LSTTL Interface**