

# MPF930, MPF960, MPF990

Preferred Device

## Small Signal MOSFET 2 Amps, 35, 60, 90 Volts N-Channel TO-92



ON Semiconductor

<http://onsemi.com>

**2 AMPERES**  
**35, 60, 90 VOLTS**  
 **$R_{DS(on)} = 0.7 \Omega$  (MPF930)**  
 **$R_{DS(on)} = 0.8 \Omega$  (MPF960)**  
 **$R_{DS(on)} = 1.2 \Omega$  (MPF990)**

### MAXIMUM RATINGS

Rating	Symbol	MPF930	MPF960	MPF990	Unit
Drain-Source Voltage	$V_{DS}$	35	60	90	Vdc
Drain-Gate Voltage	$V_{DG}$	35	60	90	Vdc
Gate-Source Voltage - Continuous - Non-repetitive ( $t_p \leq 50 \mu s$ )	$V_{GS}$ $V_{GSM}$		$\pm 20$ $\pm 40$		Vdc Vpk
Drain Current Continuous (Note 1.) Pulsed (Note 2.)	$I_D$ $I_{DM}$		2.0 3.0		Adc
Total Device Dissipation @ $T_A = 25^\circ C$ Derate above $25^\circ C$	$P_D$		1.0 8.0		Watts mW/ $^\circ C$
Operating and Storage Junction Temperature Range	$T_J, T_{stg}$		-55 to 150		$^\circ C$
Thermal Resistance	$\theta_{JA}$		125		$^\circ C/W$

1. The Power Dissipation of the package may result in a lower continuous drain current.
2. Pulse Test: Pulse Width  $\leq 300 \mu s$ , Duty Cycle  $\leq 2.0\%$ .

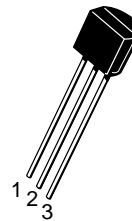
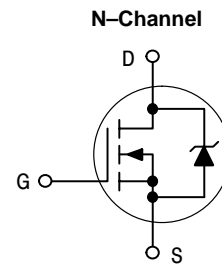

TO-92  
CASE 29  
Style 22

### MARKING DIAGRAM & PIN ASSIGNMENT

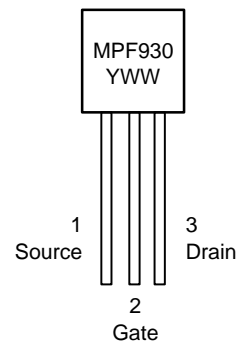

Y = Year  
WW = Work Week

### ORDERING INFORMATION

See detailed ordering and shipping information in the package dimensions section on page 3 of this data sheet.

**Preferred** devices are recommended choices for future use and best overall value.

# MPF930, MPF960, MPF990

## ELECTRICAL CHARACTERISTICS (T<sub>A</sub> = 25°C unless otherwise noted)

Characteristic	Symbol	Min	Typ	Max	Unit
----------------	--------	-----	-----	-----	------

### OFF CHARACTERISTICS

Drain-Source Breakdown Voltage (V <sub>GS</sub> = 0, I <sub>D</sub> = 10 μAdc)	MPF930 MPF960 MPF990	V <sub>(BR)DSX</sub>	35 60 90	- - -	- - -	Vdc
Gate Reverse Current (V <sub>GS</sub> = 15 Vdc, V <sub>DS</sub> = 0)		I <sub>GSS</sub>	-	-	50	nAdc

### ON CHARACTERISTICS (Note 2.)

Zero-Gate-Voltage Drain Current (V <sub>DS</sub> = Maximum Rating, V <sub>GS</sub> = 0)		I <sub>DSS</sub>	-	-	10	μAdc	
Gate Threshold Voltage (I <sub>D</sub> = 1.0 mAdc, V <sub>DS</sub> = V <sub>GS</sub> )		V <sub>GS(Th)</sub>	1.0	-	3.5	Vdc	
Drain-Source On-Voltage (V <sub>GS</sub> = 10 Vdc) (I <sub>D</sub> = 0.5 Adc)	MPF930	V <sub>DS(on)</sub>	-	0.4	0.7	Vdc	
	MPF960		-	0.6	0.8		
	MPF990		-	0.6	1.2		
	(I <sub>D</sub> = 1.0 Adc)		MPF930	-	0.9		1.4
			MPF960	-	1.2		1.7
			MPF990	-	1.2		2.4
	(I <sub>D</sub> = 2.0 Adc)		MPF930	-	2.2		3.0
			MPF960	-	2.8		3.5
			MPF990	-	2.8		4.8
Static Drain-Source On Resistance (V <sub>GS</sub> = 10 Vdc, I <sub>D</sub> = 1.0 Adc)	MPF930 MPF960 MPF990	r <sub>DS(on)</sub>	- - -	0.9 1.2 1.2	1.4 1.7 2.0	Ω	
On-State Drain Current (V <sub>DS</sub> = 25 Vdc, V <sub>GS</sub> = 10 Vdc)		I <sub>D(on)</sub>	1.0	2.0	-	Amps	

### SMALL-SIGNAL CHARACTERISTICS

Input Capacitance (V <sub>DS</sub> = 25 Vdc, V <sub>GS</sub> = 0, f = 1.0 MHz)		C <sub>iss</sub>	-	70	-	pF
Reverse Transfer Capacitance (V <sub>DS</sub> = 25 Vdc, V <sub>GS</sub> = 0, f = 1.0 MHz)		C <sub>rss</sub>	-	20	-	pF
Output Capacitance (V <sub>DS</sub> = 25 Vdc, V <sub>GS</sub> = 0, f = 1.0 MHz)		C <sub>oss</sub>	-	49	-	pF
Forward Transconductance (V <sub>DS</sub> = 25 Vdc, I <sub>D</sub> = 0.5 Adc)		g <sub>fs</sub>	200	380	-	mmhos

### SWITCHING CHARACTERISTICS

Turn-On Time	t <sub>on</sub>	-	7.0	15	ns
Turn-Off Time	t <sub>off</sub>	-	7.0	15	ns

2. Pulse Test: Pulse Width ≤ 300 μs, Duty Cycle ≤ 2.0%.

# MPF930, MPF960, MPF990

## RESISTIVE SWITCHING

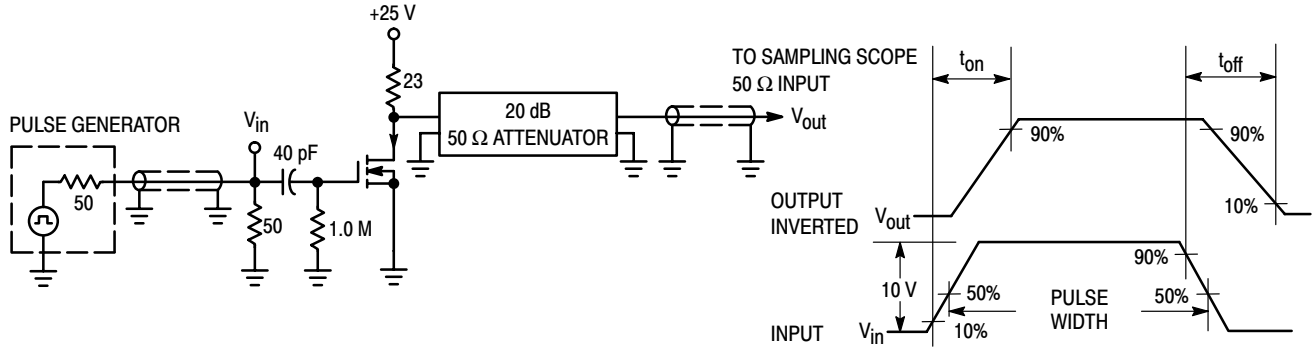

Figure 1. Switching Test Circuit

Figure 2. Switching Waveforms

## ORDERING INFORMATION

Device	Package	Shipping
MPF930	TO-92	1000 Unit/Box
MPF930RLRE	TO-92	2000 Tape & Reel
MPF930A	TO-92	1000 Unit/Box
MPF930ARLRE	TO-92	2000 Tape & Reel
MPF960	TO-92	1000 Unit/Box
MPF960RLRA	TO-92	2000 Tape & Reel
MPF990	TO-92	1000 Unit/Box
MPF990RLRA	TO-92	2000 Tape & Reel
MPF990RLRP	TO-92	2000 Ammo Pack

# MPF930, MPF960, MPF990

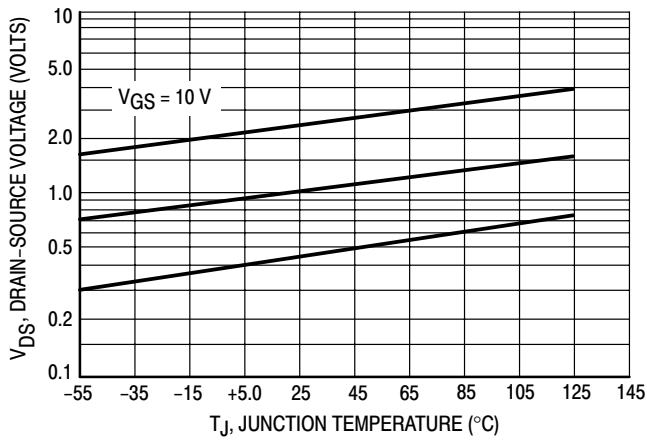

Figure 3. On Voltage versus Temperature

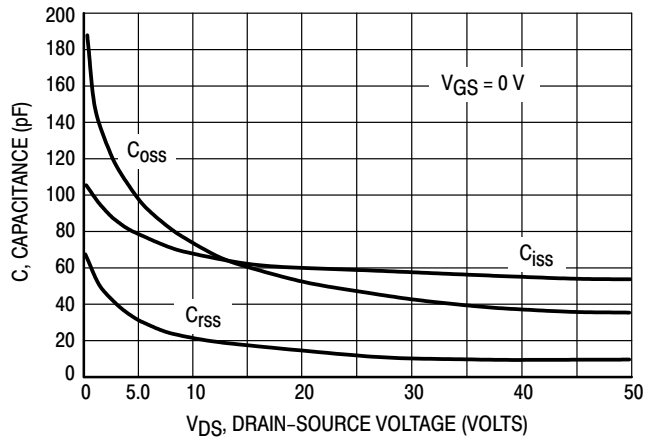

Figure 4. Capacitance Variation

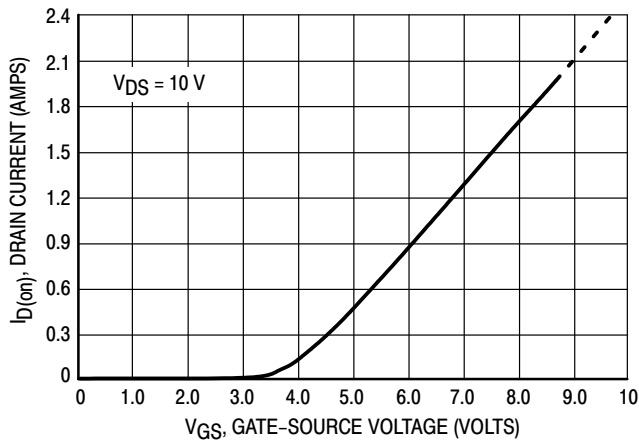

Figure 5. Transfer Characteristic

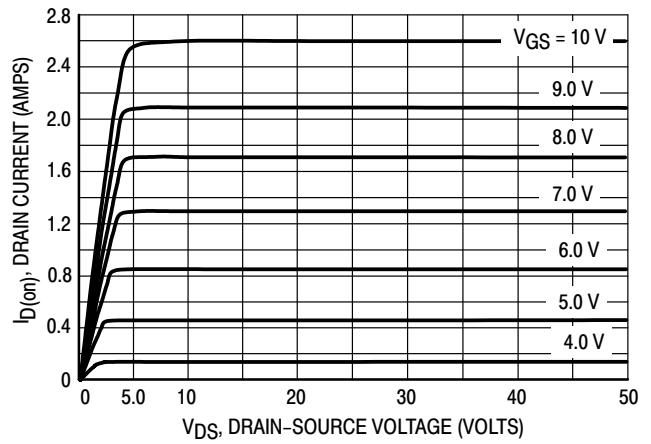

Figure 6. Output Characteristic

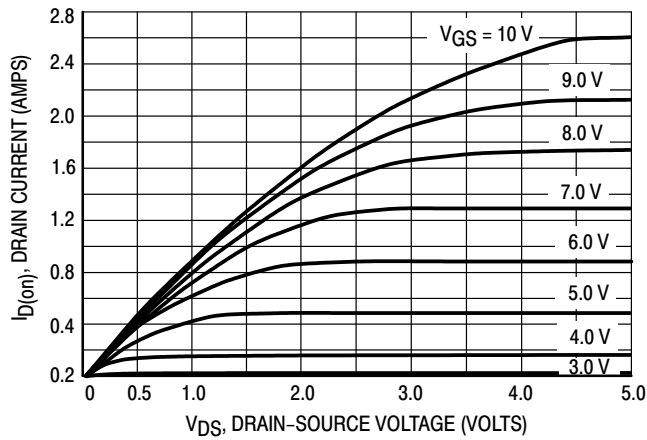
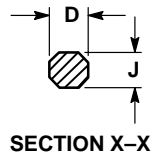
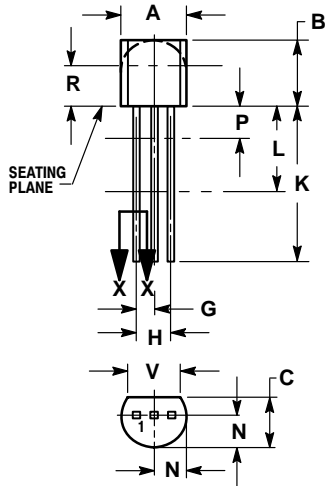

Figure 7. Saturation Characteristic

# MPF930, MPF960, MPF990

## PACKAGE DIMENSIONS

TO-92  
CASE 29-11  
ISSUE AL



### NOTES:

1. DIMENSIONING AND TOLERANCING PER ANSI Y14.5M, 1982.
2. CONTROLLING DIMENSION: INCH.
3. CONTOUR OF PACKAGE BEYOND DIMENSION R IS UNCONTROLLED.
4. LEAD DIMENSION IS UNCONTROLLED IN P AND BEYOND DIMENSION K MINIMUM.

DIM	INCHES		MILLIMETERS	
	MIN	MAX	MIN	MAX
A	0.175	0.205	4.45	5.20
B	0.170	0.210	4.32	5.33
C	0.125	0.165	3.18	4.19
D	0.016	0.021	0.407	0.533
G	0.045	0.055	1.15	1.39
H	0.095	0.105	2.42	2.66
J	0.015	0.020	0.39	0.50
K	0.500	---	12.70	---
L	0.250	---	6.35	---
N	0.080	0.105	2.04	2.66
P	---	0.100	---	2.54
R	0.115	---	2.93	---
V	0.135	---	3.43	---

### STYLE 22:

- PIN 1. SOURCE
- GATE
- DRAIN

**Notes**

## Notes

# MPF930, MPF960, MPF990

**ON Semiconductor** and  are trademarks of Semiconductor Components Industries, LLC (SCILLC). SCILLC reserves the right to make changes without further notice to any products herein. SCILLC makes no warranty, representation or guarantee regarding the suitability of its products for any particular purpose, nor does SCILLC assume any liability arising out of the application or use of any product or circuit, and specifically disclaims any and all liability, including without limitation special, consequential or incidental damages. "Typical" parameters which may be provided in SCILLC data sheets and/or specifications can and do vary in different applications and actual performance may vary over time. All operating parameters, including "Typicals" must be validated for each customer application by customer's technical experts. SCILLC does not convey any license under its patent rights nor the rights of others. SCILLC products are not designed, intended, or authorized for use as components in systems intended for surgical implant into the body, or other applications intended to support or sustain life, or for any other application in which the failure of the SCILLC product could create a situation where personal injury or death may occur. Should Buyer purchase or use SCILLC products for any such unintended or unauthorized application, Buyer shall indemnify and hold SCILLC and its officers, employees, subsidiaries, affiliates, and distributors harmless against all claims, costs, damages, and expenses, and reasonable attorney fees arising out of, directly or indirectly, any claim of personal injury or death associated with such unintended or unauthorized use, even if such claim alleges that SCILLC was negligent regarding the design or manufacture of the part. SCILLC is an Equal Opportunity/Affirmative Action Employer.

## PUBLICATION ORDERING INFORMATION

### NORTH AMERICA Literature Fulfillment:

Literature Distribution Center for ON Semiconductor  
P.O. Box 5163, Denver, Colorado 80217 USA  
**Phone:** 303-675-2175 or 800-344-3860 Toll Free USA/Canada  
**Fax:** 303-675-2176 or 800-344-3867 Toll Free USA/Canada  
**Email:** ONlit@hibbertco.com  
Fax Response Line: 303-675-2167 or 800-344-3810 Toll Free USA/Canada

**N. American Technical Support:** 800-282-9855 Toll Free USA/Canada

**EUROPE:** LDC for ON Semiconductor – European Support

**German Phone:** (+1) 303-308-7140 (Mon-Fri 2:30pm to 7:00pm CET)  
**Email:** ONlit-german@hibbertco.com  
**French Phone:** (+1) 303-308-7141 (Mon-Fri 2:00pm to 7:00pm CET)  
**Email:** ONlit-french@hibbertco.com  
**English Phone:** (+1) 303-308-7142 (Mon-Fri 12:00pm to 5:00pm GMT)  
**Email:** ONlit@hibbertco.com

**EUROPEAN TOLL-FREE ACCESS\*: 00-800-4422-3781**

\*Available from Germany, France, Italy, UK, Ireland

### CENTRAL/SOUTH AMERICA:

**Spanish Phone:** 303-308-7143 (Mon-Fri 8:00am to 5:00pm MST)  
**Email:** ONlit-spanish@hibbertco.com  
**Toll-Free from Mexico:** Dial 01-800-288-2872 for Access –  
then Dial 866-297-9322

**ASIA/PACIFIC:** LDC for ON Semiconductor – Asia Support

**Phone:** 303-675-2121 (Tue-Fri 9:00am to 1:00pm, Hong Kong Time)  
**Toll Free from Hong Kong & Singapore:**  
**001-800-4422-3781**

**Email:** ONlit-asia@hibbertco.com

**JAPAN:** ON Semiconductor, Japan Customer Focus Center

4-32-1 Nishi-Gotanda, Shinagawa-ku, Tokyo, Japan 141-0031  
**Phone:** 81-3-5740-2700  
**Email:** r14525@onsemi.com

**ON Semiconductor Website:** <http://onsemi.com>

For additional information, please contact your local Sales Representative.