

## Two-stage performance filter

## FN 670

- Current ratings from 1.8 to 10A
- Very high differential and common mode attenuation
- Good high frequency attenuation
- Nennströme von 1,8 bis 10A
- Sehr hohe differentielle und Gleichtakt-Dämpfung
- Gute Hochfrequenzdämpfung
- Courants de service de 1,8 à 10A
- Très bonne atténuation en modes différentiel et commun
- Bonne atténuation à des hautes fréquences



### Filter selection table

Choose the family FN xxx with the required current rating and features, and add /?? to determine input/output (line/load) connection style. Example: FN 670-3/06 is a 3A filter with fast-on connections.

### Approvals



Family	Connections		Current ratings at 40°C (25°) A	Inductance L/L1 mH	Housing	Weight g	
	/06	/07				/06	/07
FN 670 -1.8 /??	/06	/07	1.6 (1.8)	7.2/7.2	K2	225	240
FN 670 -3 /??	/06	/07	2.5 (3)	12.2/1.8	K2	240	245
FN 670 -6 /??	/06	/07	5 (6)	7/7	K2	245	260
FN 670 -10 /??	/06	/07	8.0 (10)	10.4/2.7	L1	570	620

### Additional specifications

Filter type	Capacitance		Res. R MΩ	Maximum leakage μA/phase	Maximum operating voltage		Operating frequency Hz	Hipot test voltage	
	Cx/Cx1 nF	Cy nF			VAC	Hz		PN→E VAC	P→N VAC
Standard types	470/150	2.2	0.47	190	250	50/60	DC to 400	2000	1700

MTBF at 40°C, 230V, per Mil-HB-217F: 300,000 hours (for VDE-approved current ratings).

## FN 670 insertion loss

Per CISPR 17; A = 50Ω/50Ω sym, B = 50Ω/50Ω asym, C = 0.1Ω/100Ω sym, D = 100Ω/0.1Ω sym

### 1.8 amp types

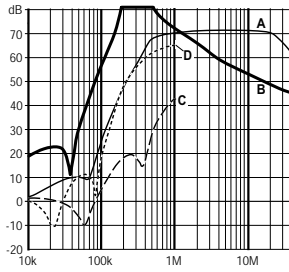

### 3 amp types

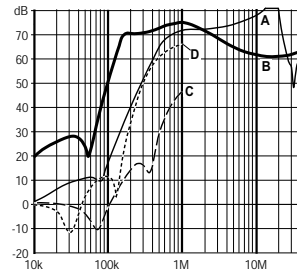

### 6 amp types

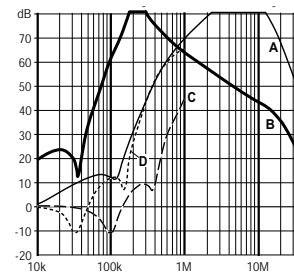

### 10 amp types

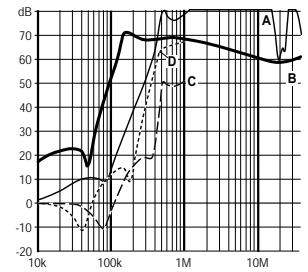

## Electrical schematic

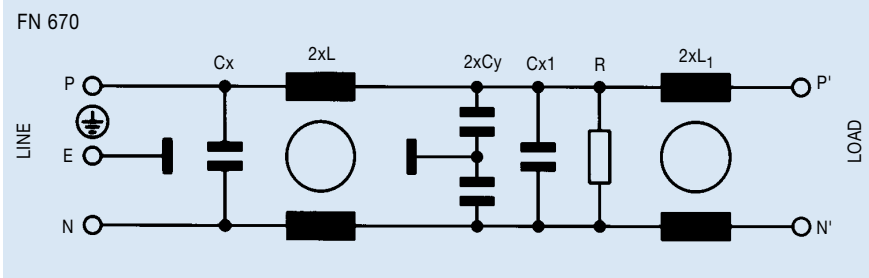

See tables for component values.

## Mechanical data

	FN 670-1.8 /-3/-6	FN 670-10	Tol.* mm
	K2	L1	
<b>A</b>	85	105	± 0.5
<b>B</b>	54	99.5 ± 1	± 0.5
<b>C</b>	40	38	± 1
<b>D</b>	65	84.5	± 1
<b>E</b>		79	± 0.5
<b>F</b>	75	95	± 0.2
<b>G</b>		51	± 0.1
<b>J</b>	27	40	± 0.5
<b>K</b>	12	9.5	± 0.5
<b>L</b>	29.5	19	± 0.5
<b>M</b>	5.3	4.4	± 0.1
<b>N</b>	6.3	6	± 0.1
<b>Y</b>		6	± 1
<b>Z</b>		140	+ 5

\* Measurements share this common tolerance unless otherwise stated.

### Front view

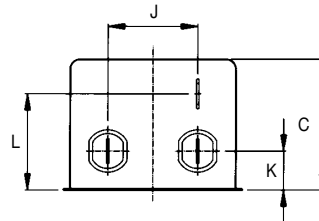

Housing K2

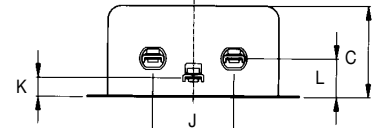

Housing L1

### Top view

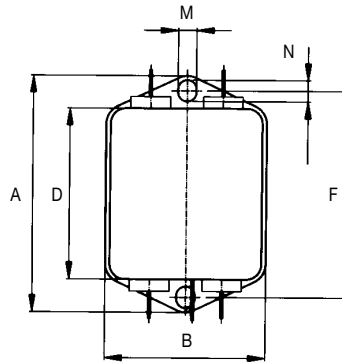

Housing K2

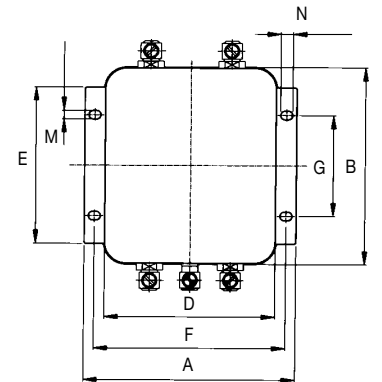

Housing L1

All dimensions in mm; 1 inch = 25.4 mm