

SOC product name ST5 “Rated current”

Certification	UL198G Listed	Rated currents 100 mA–8 A
	UL248-1, UL248-14 Recognized	Rated currents 8.1 A–30 A
	CSA C22.2 No. 59.2 Certified	Rated currents 100 mA–8 A
	CSA C22.2 No. 248.1, CSA C22.2 No. 248.14	Rated currents 8.1 A–30 A
	Component Acceptance	

Dimensions and construction

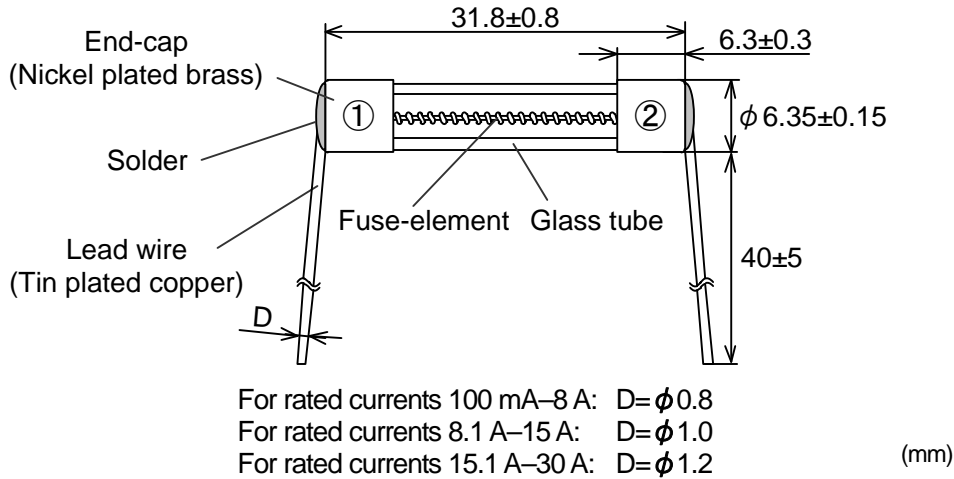

Marking

<Rated currents 100 mA–8 A>	Marking ①: SOC ST5	Marking ②: 125V “Rated current”
<Rated currents 8.1 A–30 A>	Marking ①: SOC ST5	Marking ②: 125V “Rated current”

Electrical characteristics

Certification	Rated voltage	Rated current (I _N)	Rated breaking current		Temperature rise	Current carrying capacity	Overload operation
UL CSA	AC 125 V	100 mA–8 A	10000 A	PF= 0.7–0.8	Not more than 70 K at 1.1 I _N	1.1 I _N for not less than 15 min after temperature stabilization.	Within 60 min at 1.35 I _N
	DC 125V	8.1 A–30 A	500 A	Resistive circuit	Not more than 200 K at 1.0 I _N	1.0 I _N until temperature stabilization occurs.	Within 2 min at 2.0 I _N

Rated currents

Your part number	SOC product name	Rated currents	Remarks	Your part number	SOC product name	Rated currents	Remarks
	ST5 100mA	100 mA	*1		ST5 2.5A	2.5 A	*1
	ST5 160mA	160 mA	*1		ST5 3.15A	3.15 A	*1
	ST5 200mA	200 mA	*1		ST5 4A	4 A	*1
	ST5 250mA	250 mA	*1		ST5 5A	5 A	*1
	ST5 315mA	315 mA	*1		ST5 6.3A	6.3 A	*1
	ST5 400mA	400 mA	*1		ST5 8A	8 A	*1
	ST5 500mA	500 mA	*1		ST5 10A	10 A	*2
	ST5 630mA	630 mA	*1		ST5 12A	12 A	*2
	ST5 800mA	800 mA	*1		ST5 15A	15 A	*2
	ST5 1A	1 A	*1		ST5 20A	20 A	*2
	ST5 1.25A	1.25 A	*1		ST5 25A	25 A	*2
	ST5 1.6A	1.6 A	*1		ST5 30A	30 A	*2
	ST5 2A	2 A	*1				

Environment-related substances

For the products marked with *1 in the remarks column, the six hazardous substances (lead, mercury, cadmium, hexavalent chromium, polybrominated biphenyls (PBB), and polybrominated biphenyl ethers (PBDE)) specified in the EU RoHS Directive are not used intentionally. These products conform to the EU RoHS Directive 2011/65/EU. Lead content as impurities is not more than 0.1 wt%.

For the products marked with *2 in the remarks column, the six hazardous substances are not used intentionally, except high melting temperature type solders, containing 85 wt% or more lead, that are exempted from the Directive. These products conform to the EU RoHS Directive 2011/65/EU.



Safety Precautions When Selecting and Using Fuses

WARNING: Read and follow these precautions before selecting and using fuses. Failure to properly select, install, and use fuses can result in serious injury, death, or property damage. Before final fuse selection, always test the proposed fuse in your actual equipment to ensure that the fuse satisfies all your operational and safety requirements.



Use the fuses within the specification requirements. Exceeding specification requirements may result in injury, death, or fire.

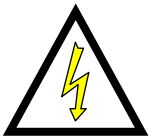

Shut down the power before touching the fuse. Failure to do so may result in electrocution or serious burns.

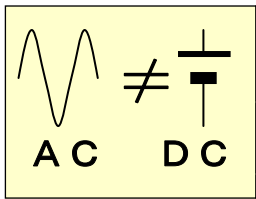

Be aware that the breaking ability of a fuse will differ depending on whether the circuit is an AC or a DC circuit. Fuses intended for use in AC circuits should therefore not be employed in DC circuits, and vice versa, as this may result in accidents such as explosions, property damage, and serious injury.

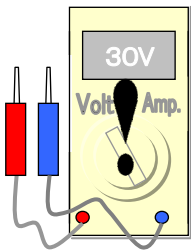

Check if the circuit voltage is large enough for fuse operation. When the circuit voltage is too small, the fuse may not operate even though an abnormal current passes through it as the current decreases due to the increase of the fuse resistance.

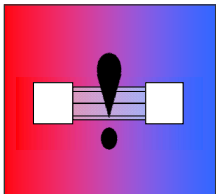

Consider the effect of the ambient temperature when you use the fuse. The electrical performance of the fuse may vary depending on the temperature.

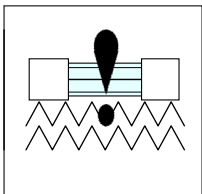

Use the fuse in a place where the vibration and impact levels are within the specified limits. Exceeding these limits may result in disconnection of the fuse-element.

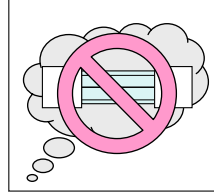

Do not use the fuse where it is exposed to high humidity, and corrosive and flammable gases. Doing so may result in nuisance operations, disconnection of the fuse-element, or explosions.

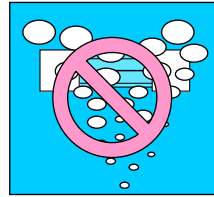

Do not apply ultrasonic cleaning to the fuse. Ultrasonic cleaning may result in disconnection of the fuse-element.

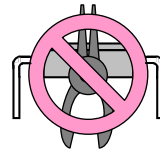

Do not form the lead when the temperature of the fuse is greater than or equal to 40 °C. Lead forming at these temperatures may result in disconnection of the fuse-element as the load is applied to it.

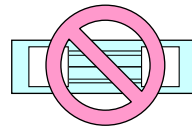

Do not apply coating or potting to the fuse. Doing so may result in disconnection of the fuse-element or a change in the fuse's characteristics.

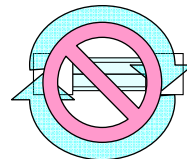

Use sample fuses only for evaluation. Do not reuse fuses. Properly dispose of used fuses.



When inserting a fuse into a fuseholder, avoid applying excessive force as this may result in the fuse cracking or contact failure which will significantly reduce its ability to work properly or shorten its life.

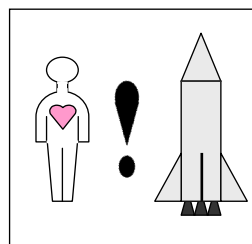

When the fuse is used for a life support system or equipment that requires high reliability, examine and evaluate the fuse in actual circuit conditions more carefully than is necessary for other general electronic equipment.

FOR REFERENCE ONLY (ご参考)

I-t Curve

このI-t特性図は、弊社が試験条件を特定して測定した実測値の平均値だけをプロットしてあります。参考値であり保証値ではありません。
ヒューズの特性はその使用条件により変化しますので、お客様にヒューズのご使用条件下で、ヒューズがお客様のご要求を満足しているかを実際にご確認頂く必要があります。

This I-t curve is a plot of the average values of the measurements obtained under conditions specified by our company. These data are for reference only and are not intended to infer any guaranteed values. The characteristics of the fuse may vary depending on the usage conditions. Always test the fuse under the actual circuit conditions.

Type: ST5

Control No.: 130508

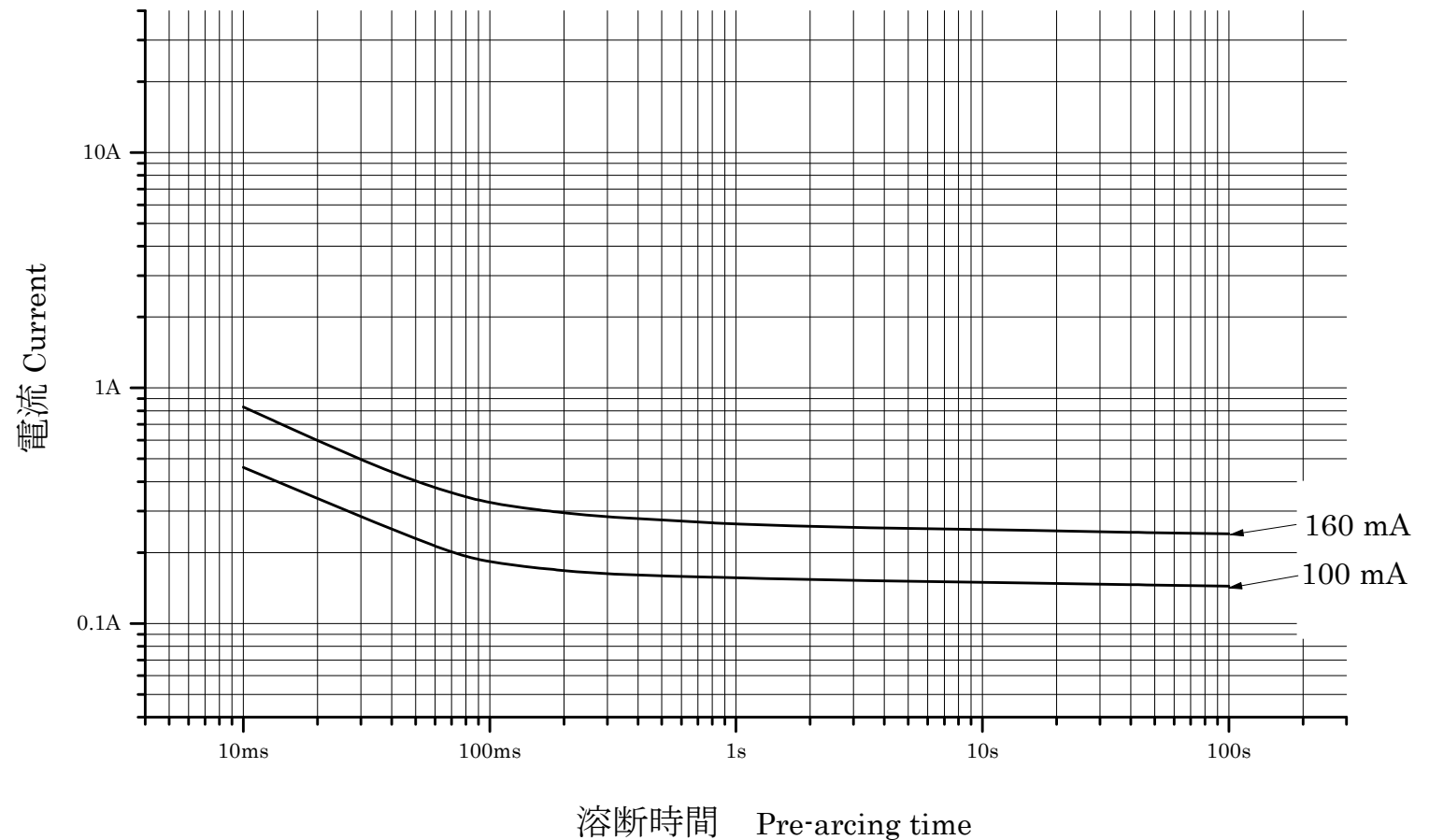

FOR REFERENCE ONLY (ご参考)

I-t Curve

このI-t特性図は、弊社が試験条件を特定して測定した実測値の平均値だけをプロットしてあります。参考値であり保証値ではありません。
ヒューズの特性はその使用条件により変化しますので、お客様にヒューズのご使用条件下で、ヒューズがお客様のご要求を満足しているかを実際にご確認頂く必要があります。

This I-t curve is a plot of the average values of the measurements obtained under conditions specified by our company. These data are for reference only and are not intended to infer any guaranteed values. The characteristics of the fuse may vary depending on the usage conditions. Always test the fuse under the actual circuit conditions.

Type: ST5

Control No.: 050401

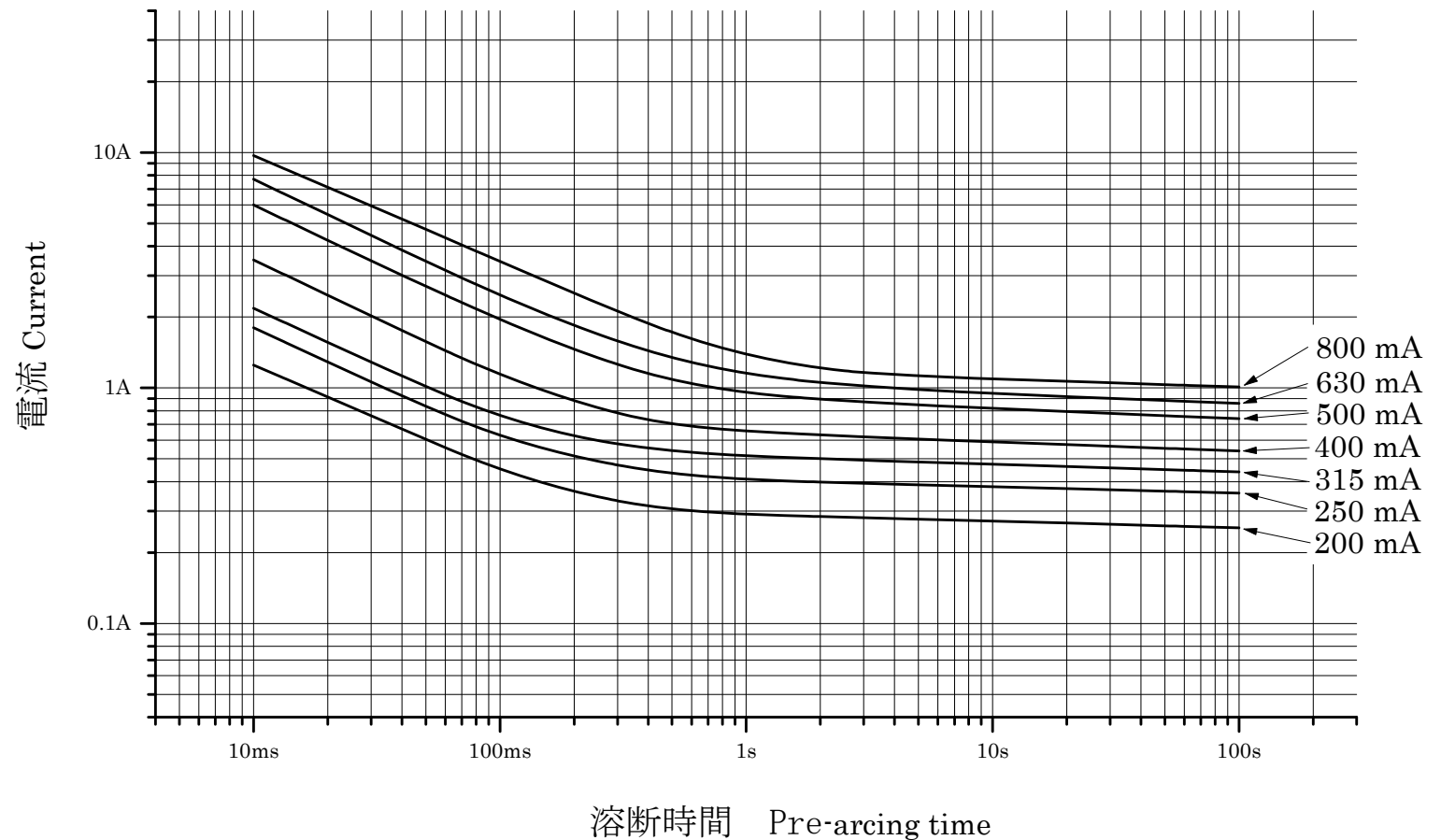

FOR REFERENCE ONLY (ご参考)

I-t Curve

このI-t特性図は、弊社が試験条件を特定して測定した実測値の平均値だけをプロットしてあります。参考値であり保証値ではありません。
ヒューズの特性はその使用条件により変化しますので、お客様にヒューズのご使用条件下で、ヒューズがお客様のご要求を満足しているかを実際にご確認頂く必要があります。

This I-t curve is a plot of the average values of the measurements obtained under conditions specified by our company. These data are for reference only and are not intended to infer any guaranteed values. The characteristics of the fuse may vary depending on the usage conditions. Always test the fuse under the actual circuit conditions.

Type: ST5

Control No.: 050401

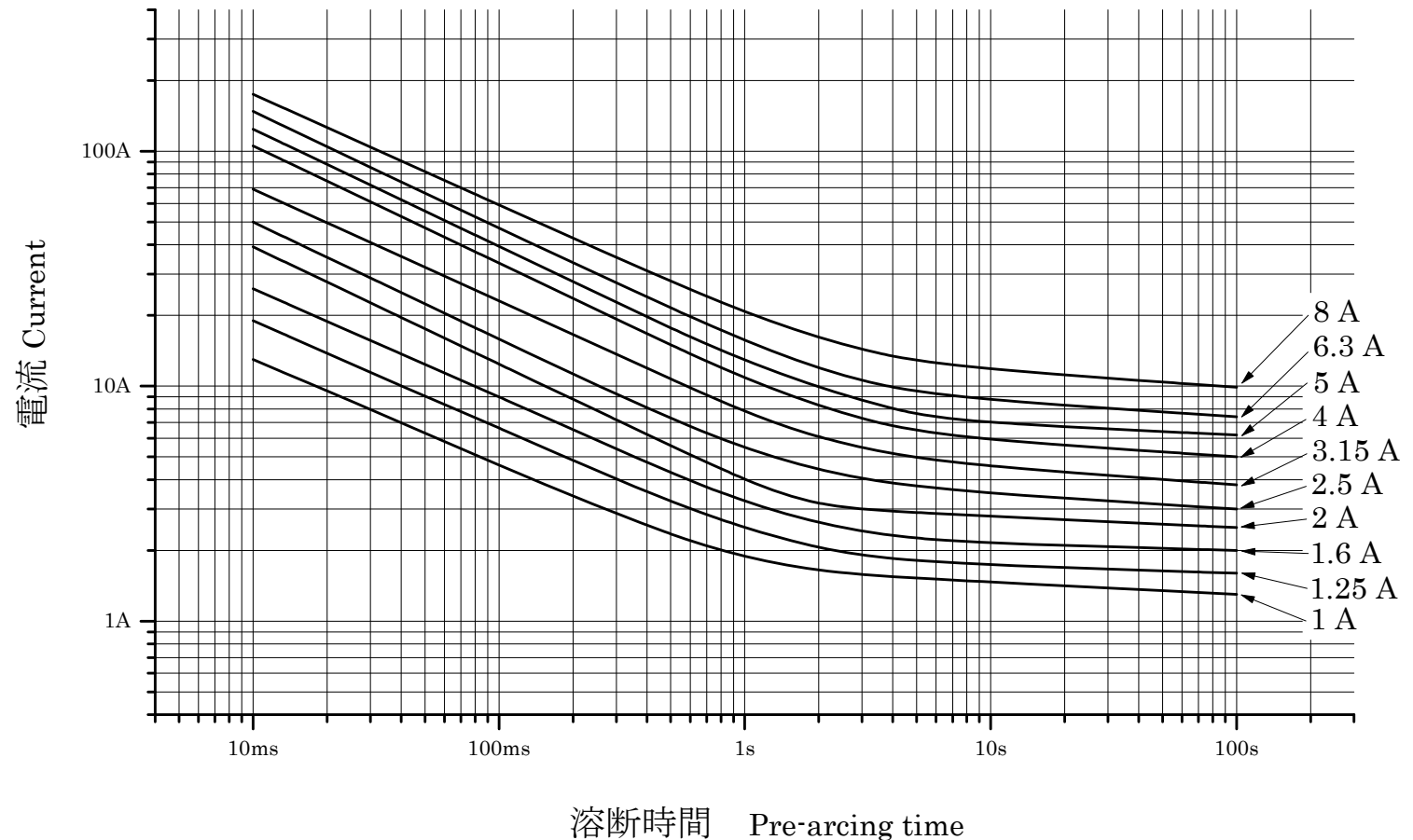

FOR REFERENCE ONLY (ご参考)

I-t Curve

このI-t特性図は、弊社が試験条件を特定して測定した実測値の平均値だけをプロットしてあります。参考値であり保証値ではありません。
ヒューズの特性はその使用条件により変化しますので、お客様にヒューズのご使用条件下で、ヒューズがお客様のご要求を満足しているかを実際にご確認頂く必要があります。

This I-t curve is a plot of the average values of the measurements obtained under conditions specified by our company. These data are for reference only and are not intended to infer any guaranteed values. The characteristics of the fuse may vary depending on the usage conditions. Always test the fuse under the actual circuit conditions.

Type: ST5

Control No.: 050401

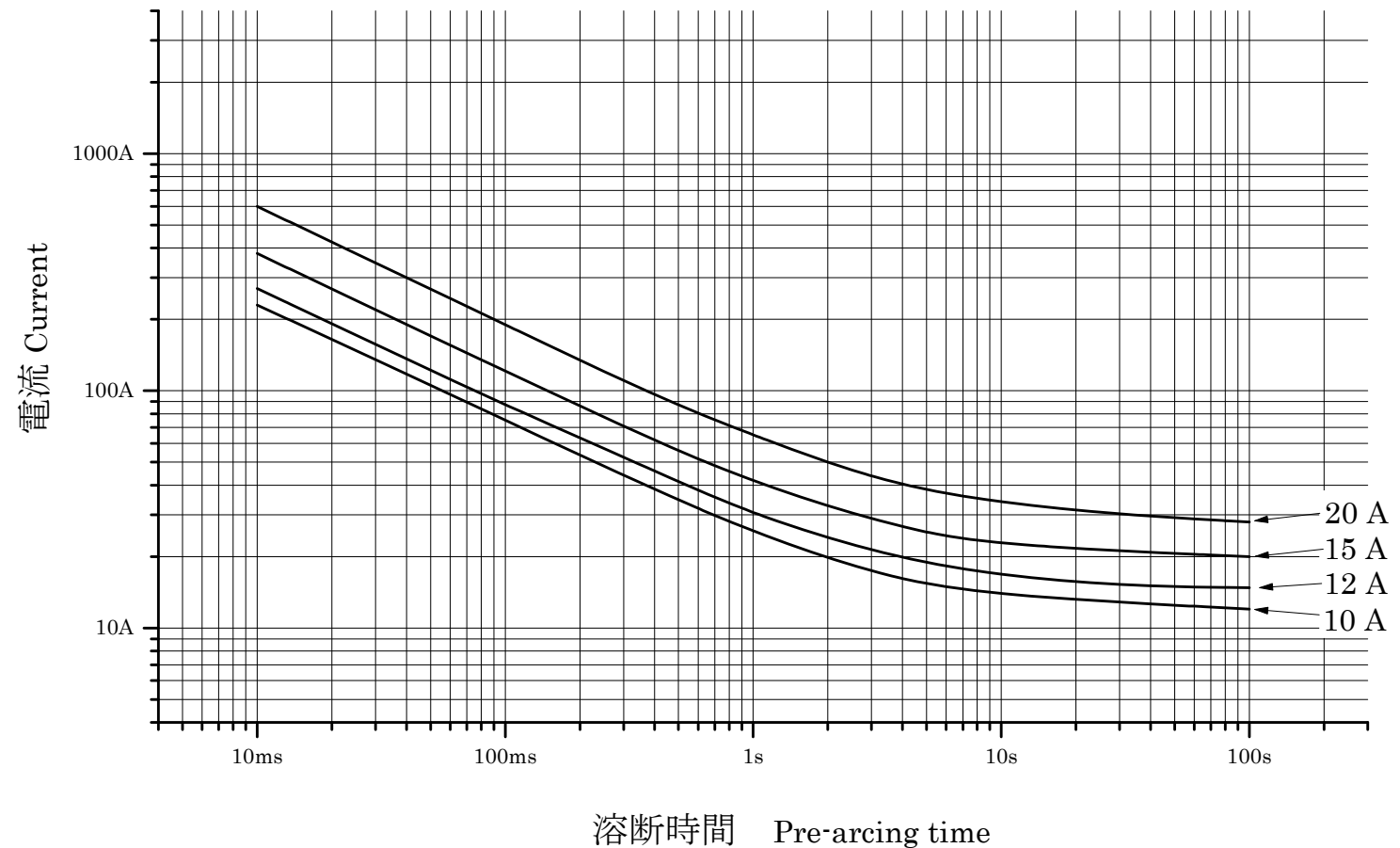

FOR REFERENCE ONLY (ご参考)

I-t Curve

このI-t特性図は、弊社が試験条件を特定して測定した実測値の平均値だけをプロットしてあります。参考値であり保証値ではありません。
ヒューズの特性はその使用条件により変化しますので、お客様にヒューズのご使用条件下で、ヒューズがお客様のご要求を満足しているかを実際にご確認頂く必要があります。

This I-t curve is a plot of the average values of the measurements obtained under conditions specified by our company. These data are for reference only and are not intended to infer any guaranteed values. The characteristics of the fuse may vary depending on the usage conditions. Always test the fuse under the actual circuit conditions.

Type: ST5

Control No.: 050401

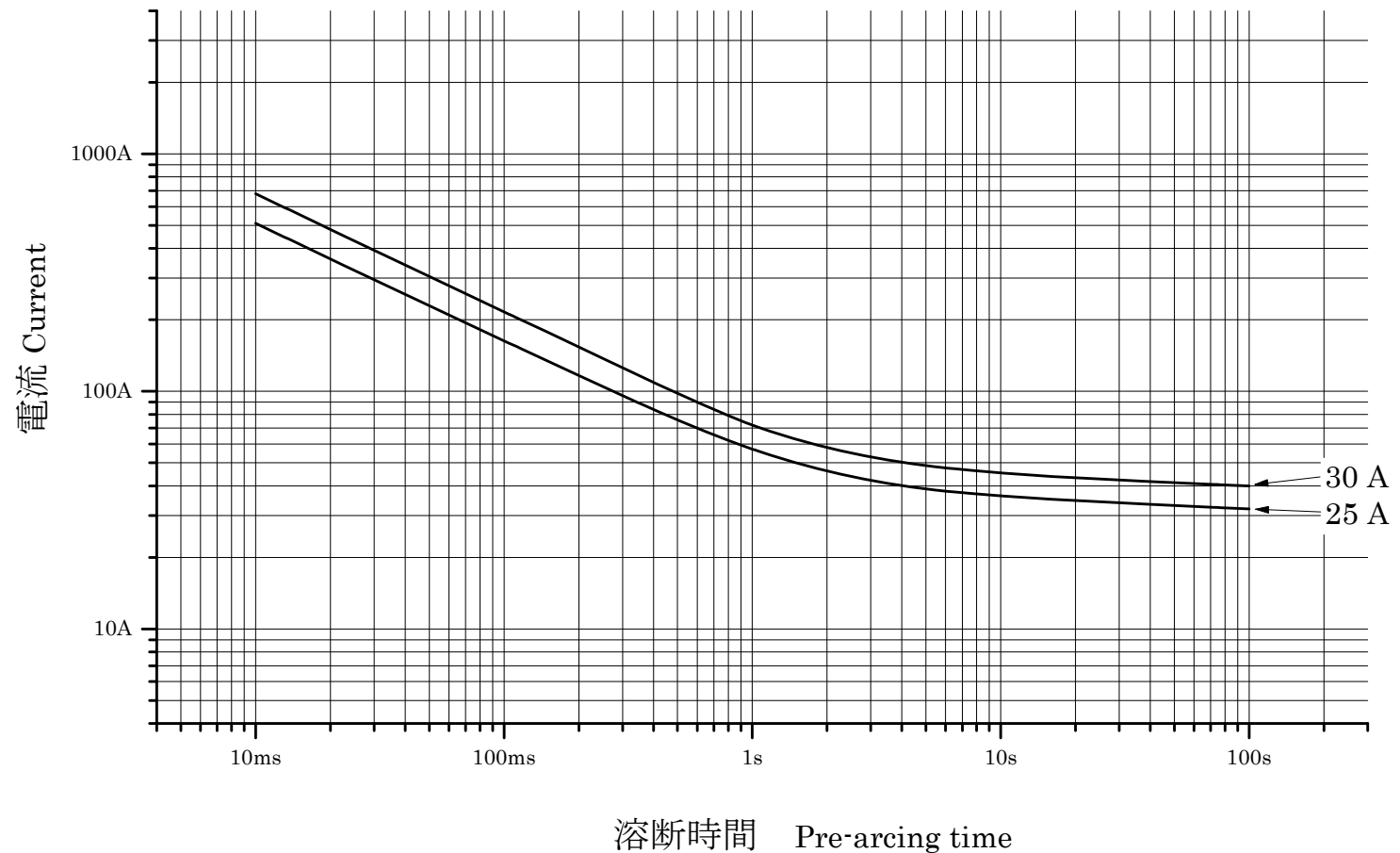

I²t-t Curve

FOR REFERENCE ONLY (ご参考)

このI²t-t特性図は、弊社が試験条件を特定して測定した実測値の平均値だけをプロットしてあります。参考値であり保証値ではありません。ヒューズの特性はその使用条件により変化しますので、お客様にヒューズのご使用条件下で、ヒューズがお客様のご要求を満足しているかを実際にご確認頂く必要があります。

This I²t-t curve is a plot of the average values of the measurements obtained under the conditions specified by our company. These data are for reference only and are not intended to infer any guaranteed values. The characteristics of the fuse may vary depending on the usage conditions. Always test the fuse under the actual circuit conditions.

Type: ST5

Control No.: 130508

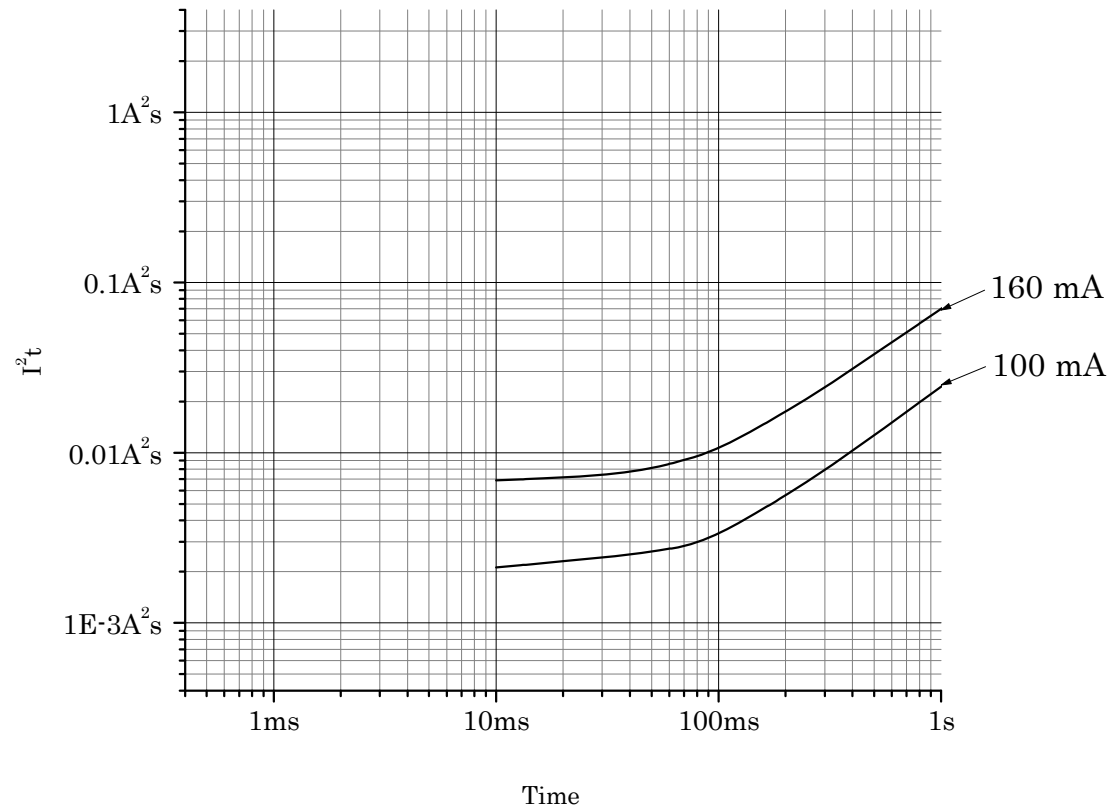

I²t-t Curve

FOR REFERENCE ONLY (ご参考)

このI²t-t特性図は、弊社が試験条件を特定して測定した実測値の平均値だけをプロットしてあります。参考値であり保証値ではありません。ヒューズの特性はその使用条件により変化しますので、お客様にヒューズのご使用条件下で、ヒューズがお客様のご要求を満足しているかを実際にご確認頂く必要があります。

This I²t-t curve is a plot of the average values of the measurements obtained under the conditions specified by our company. These data are for reference only and are not intended to infer any guaranteed values. The characteristics of the fuse may vary depending on the usage conditions. Always test the fuse under the actual circuit conditions.

Type: ST5

Control No.: 050401

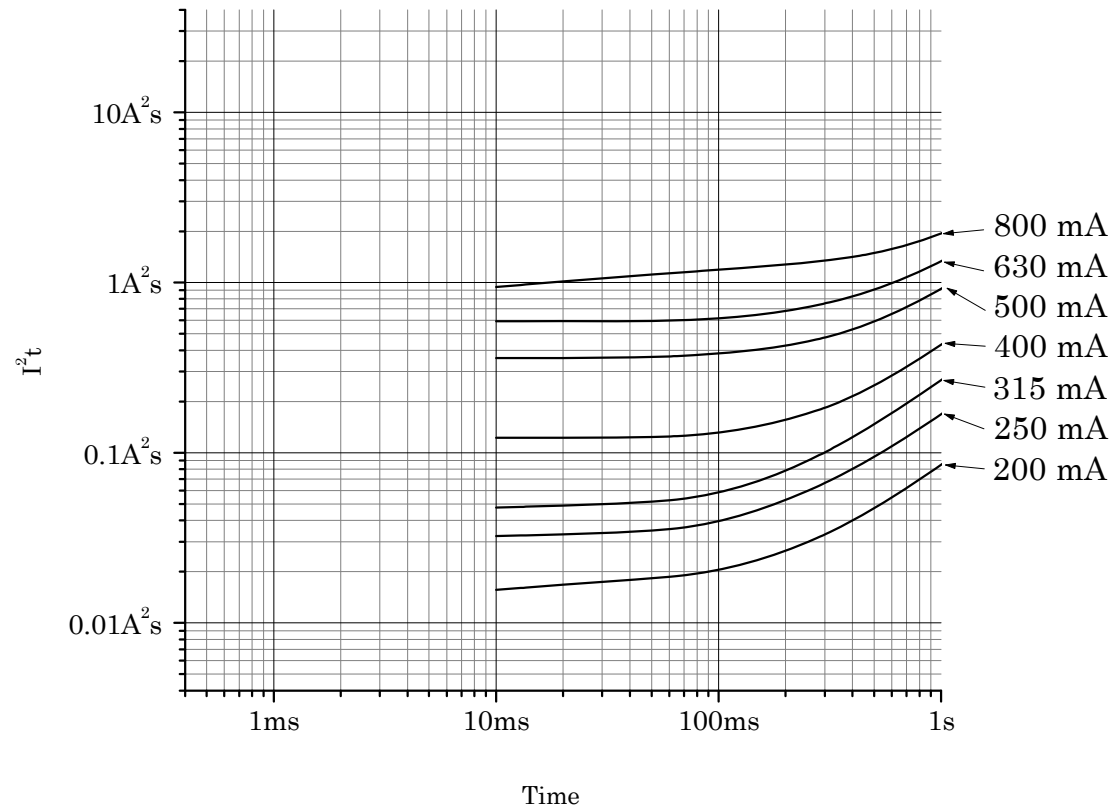

I²t-t Curve

FOR REFERENCE ONLY (ご参考)

このI²t-t特性図は、弊社が試験条件を特定して測定した実測値の平均値だけをプロットしてあります。参考値であり保証値ではありません。
ヒューズの特性はその使用条件により変化しますので、お客様にヒューズのご使用条件下で、ヒューズがお客様のご要求を満足しているかを実際にご確認頂く必要があります。

This I²t-t curve is a plot of the average values of the measurements obtained under the conditions specified by our company. These data are for reference only and are not intended to infer any guaranteed values. The characteristics of the fuse may vary depending on the usage conditions. Always test the fuse under the actual circuit conditions.

Type: ST5

Control No.: 050401

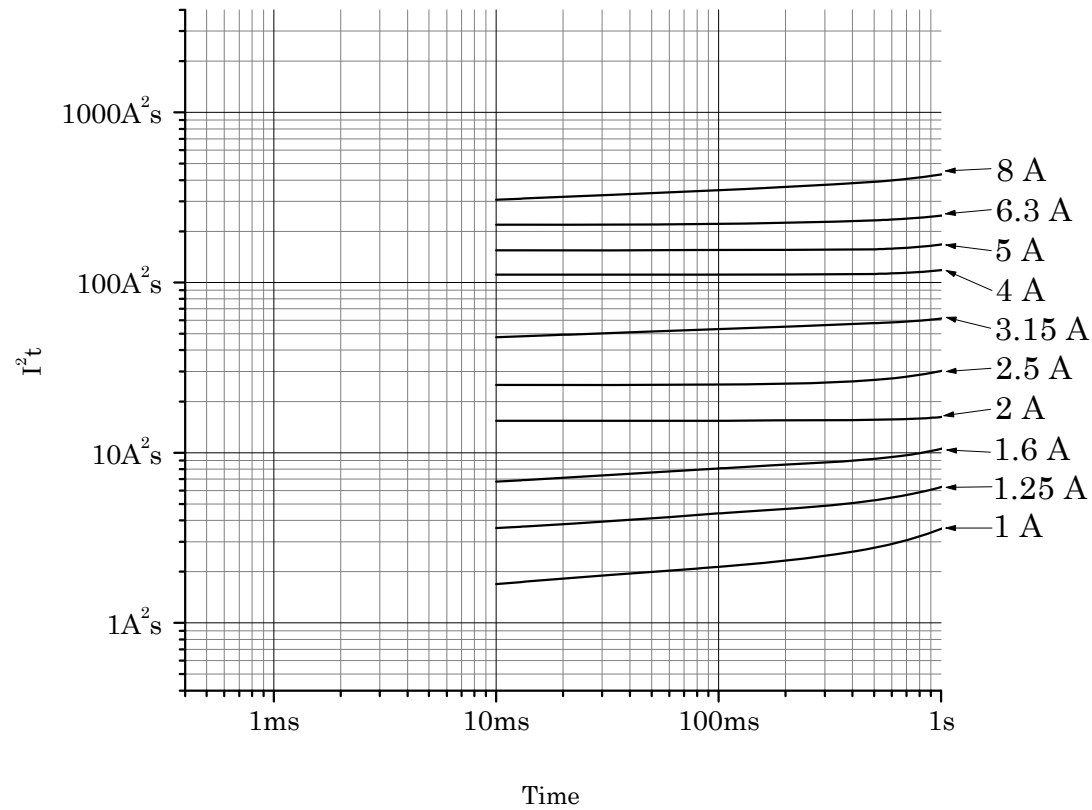

I²t-t Curve

FOR REFERENCE ONLY (ご参考)

このI²t-t特性図は、弊社が試験条件を特定して測定した実測値の平均値だけをプロットしてあります。参考値であり保証値ではありません。ヒューズの特性はその使用条件により変化しますので、お客様にヒューズのご使用条件下で、ヒューズがお客様のご要求を満足しているかを実際にご確認頂く必要があります。

This I²t-t curve is a plot of the average values of the measurements obtained under the conditions specified by our company. These data are for reference only and are not intended to infer any guaranteed values. The characteristics of the fuse may vary depending on the usage conditions. Always test the fuse under the actual circuit conditions.

Type: ST5

Control No.: 050401

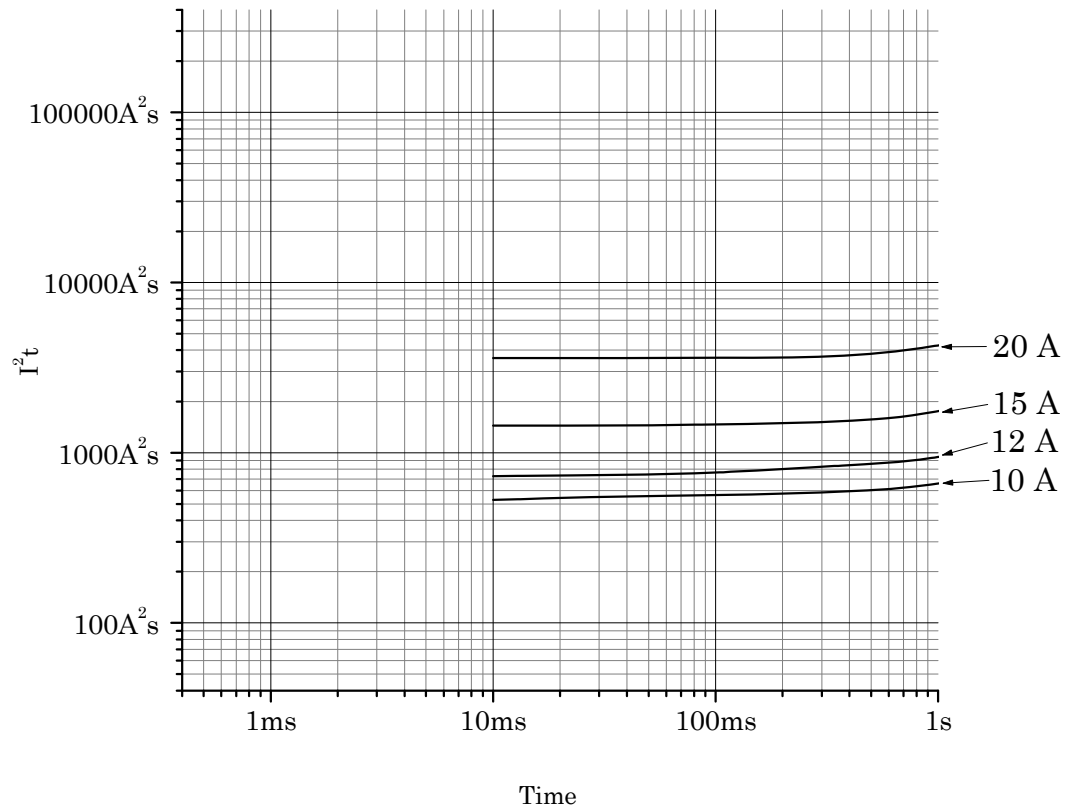

I²t-t Curve

FOR REFERENCE ONLY (ご参考)

このI²t-t特性図は、弊社が試験条件を特定して測定した実測値の平均値だけをプロットしてあります。参考値であり保証値ではありません。ヒューズの特性はその使用条件により変化しますので、お客様にヒューズのご使用条件下で、ヒューズがお客様のご要求を満足しているかを実際にご確認頂く必要があります。

This I²t-t curve is a plot of the average values of the measurements obtained under the conditions specified by our company. These data are for reference only and are not intended to infer any guaranteed values. The characteristics of the fuse may vary depending on the usage conditions. Always test the fuse under the actual circuit conditions.

Type: ST5

Control No.: 050401

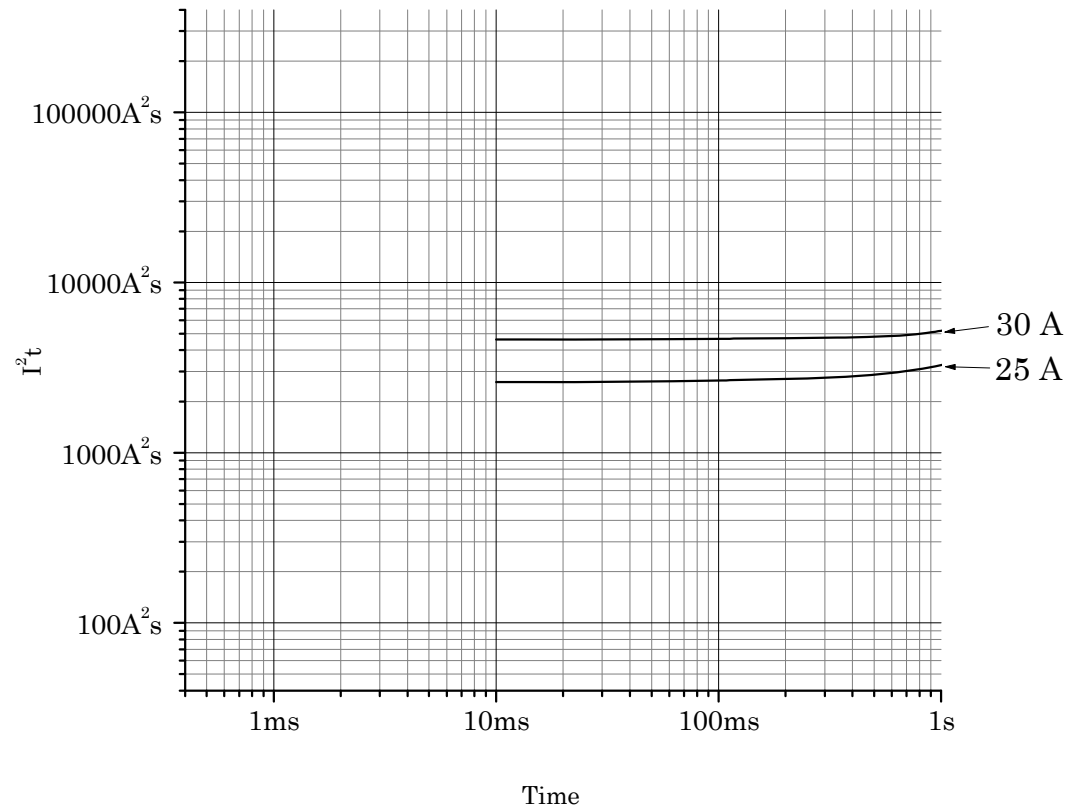

周囲温度の影響－定格電流値のリレーティング Influence of Ambient Temperature - The Re-rating of the Rated Current

この周囲温度に対する定格電流の変化を示すグラフは、周囲温度-40℃、25℃及び85℃に於いて弊社が特定した条件で測定した3点の実測値であり、お客様での実使用条件を考慮したものではありません。ヒューズの特性はその使用条件により変化しますので、お客様にヒューズのご使用条件下で、ヒューズがお客様のご要求を満足しているかを実際にご確認頂く必要があります。

This chart is a plot of the measurements obtained at the ambient temperatures of -40℃, 25℃ and 85℃ under conditions specified by SOC. The conditions of your actual application are not considered in this chart. These data are for reference purposes only and are not intended to infer any guaranteed values. Fuse characteristics may vary depending on the usage conditions. Always test the fuse under the actual circuit conditions.

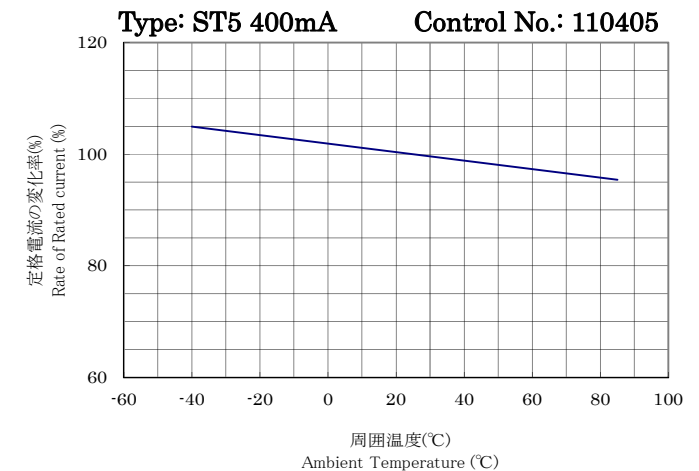
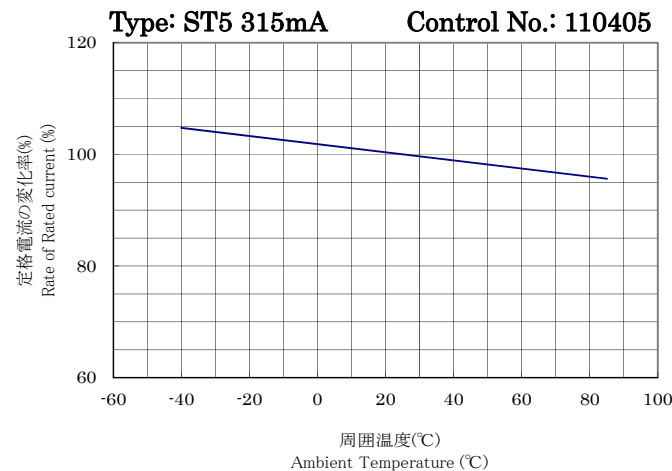
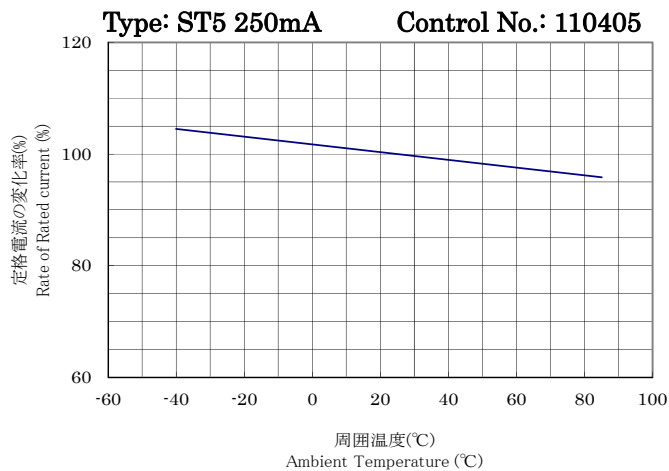
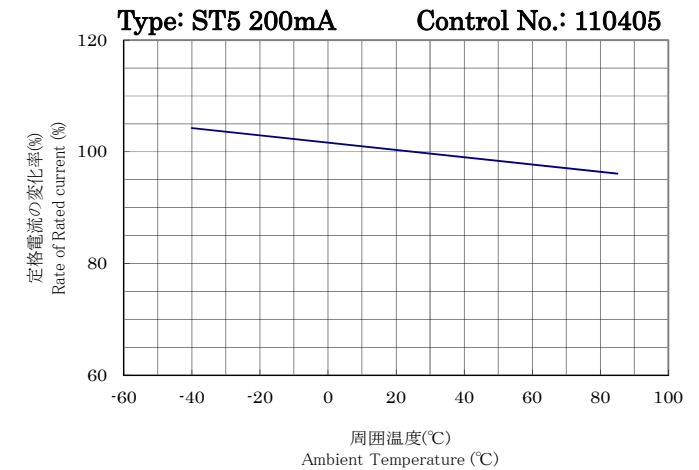
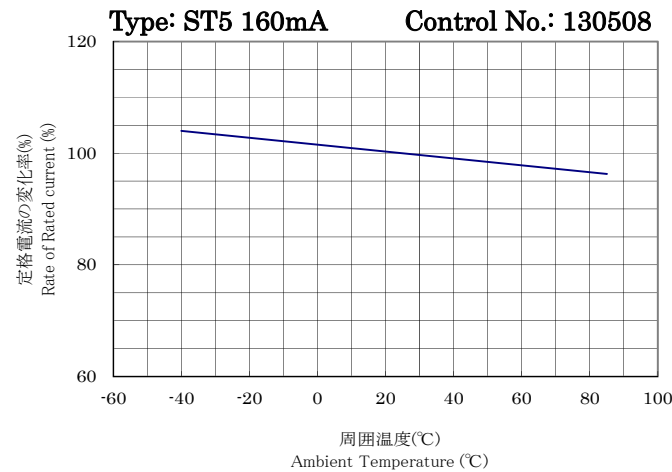
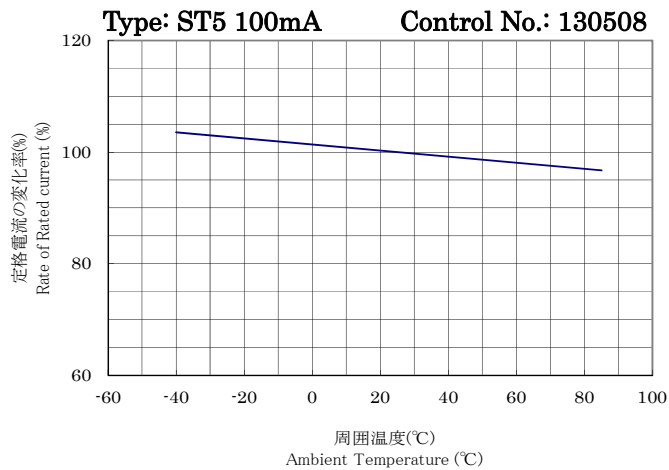

周囲温度の影響－定格電流値のリレーティング

Influence of Ambient Temperature - The Re-rating of the Rated Current

この周囲温度に対する定格電流の変化を示すグラフは、周囲温度-40℃、25℃及び85℃に於いて弊社が特定した条件で測定した3点の実測値であり、お客様での実使用条件を考慮したものではありません。ヒューズの特性はその使用条件により変化しますので、お客様にヒューズのご使用条件下で、ヒューズがお客様のご要求を満足しているかを実際にご確認頂く必要があります。

This chart is a plot of the measurements obtained at the ambient temperatures of -40℃, 25℃ and 85℃ under conditions specified by SOC. The conditions of your actual application are not considered in this chart. These data are for reference purposes only and are not intended to infer any guaranteed values. Fuse characteristics may vary depending on the usage conditions. Always test the fuse under the actual circuit conditions.

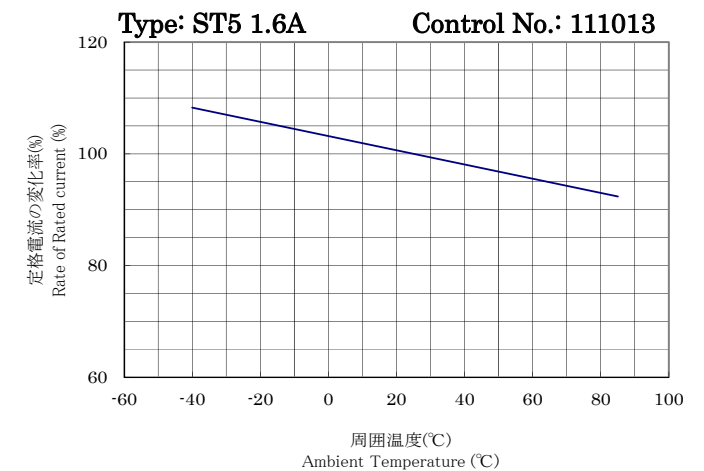
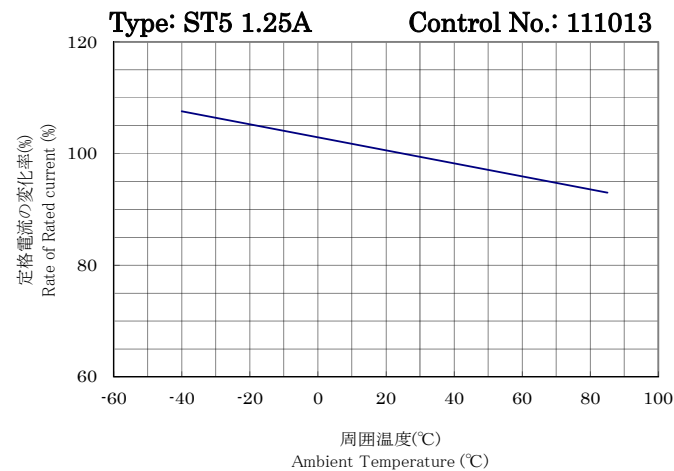
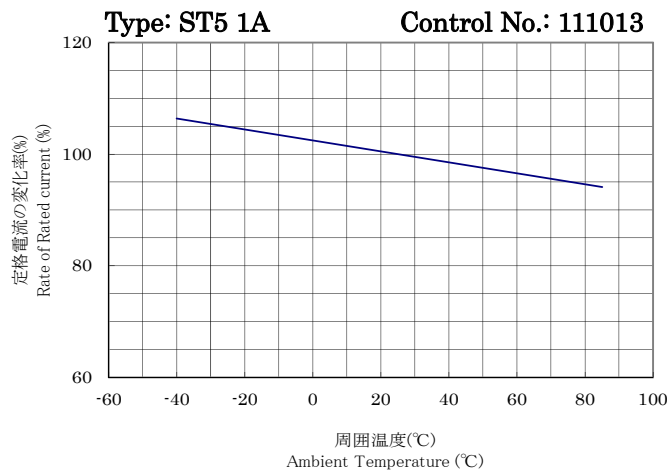
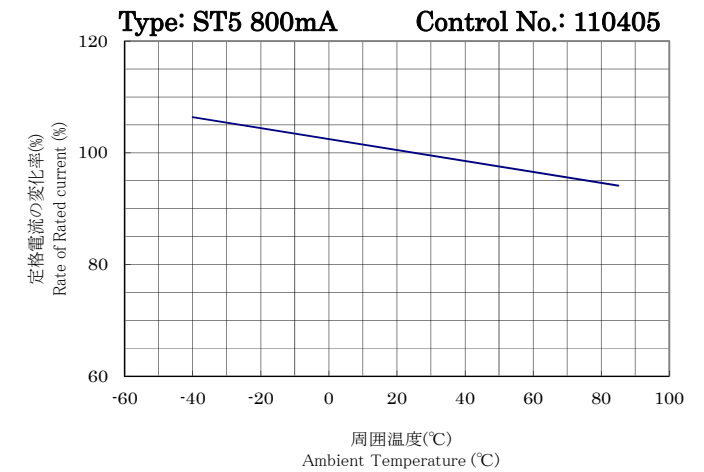
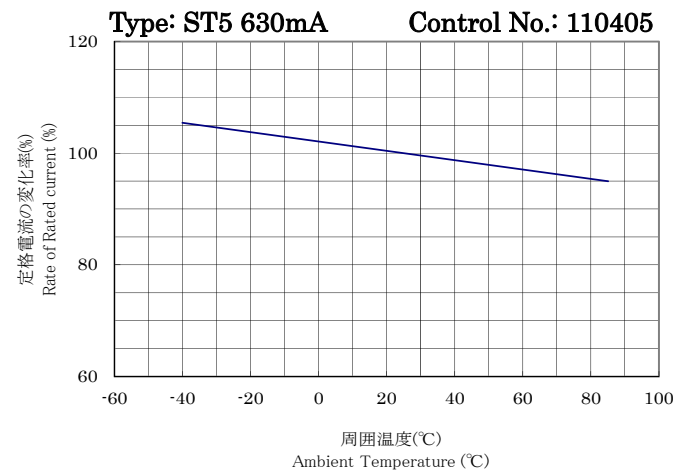
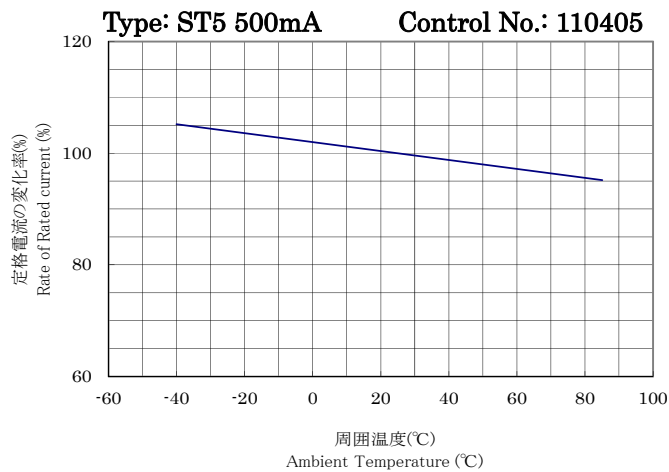

周囲温度の影響－定格電流値のリレーティング

Influence of Ambient Temperature - The Re-rating of the Rated Current

この周囲温度に対する定格電流の変化を示すグラフは、周囲温度-40℃、25℃及び85℃に於いて弊社が特定した条件で測定した3点の実測値であり、お客様での実使用条件を考慮したものではありません。ヒューズの特性はその使用条件により変化しますので、お客様にヒューズのご使用条件下で、ヒューズがお客様のご要求を満足しているかを実際にご確認頂く必要があります。

This chart is a plot of the measurements obtained at the ambient temperatures of -40℃, 25℃ and 85℃ under conditions specified by SOC. The conditions of your actual application are not considered in this chart. These data are for reference purposes only and are not intended to infer any guaranteed values. Fuse characteristics may vary depending on the usage conditions. Always test the fuse under the actual circuit conditions.

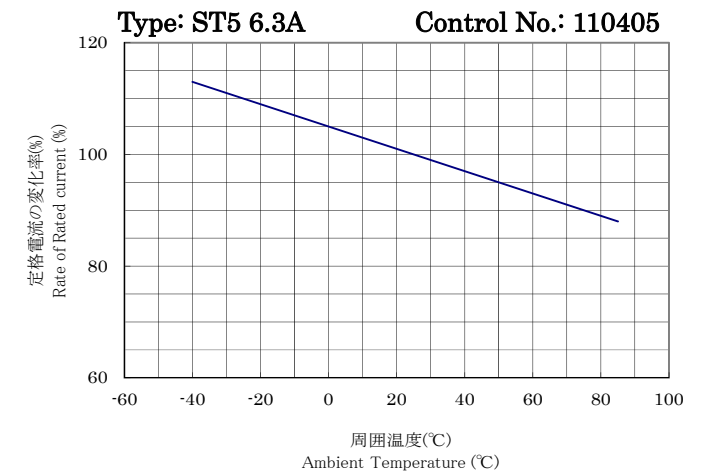
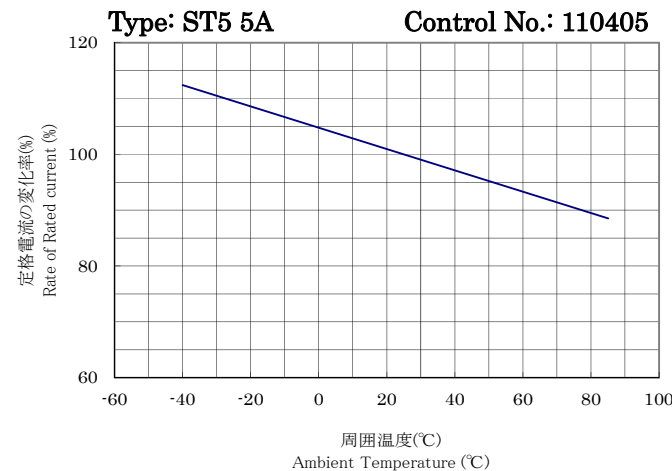
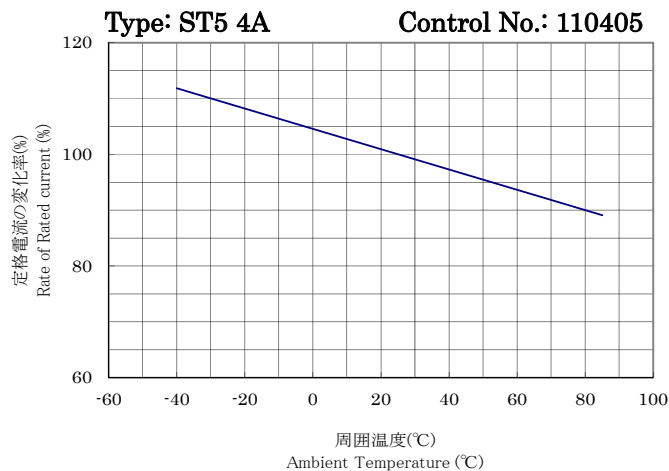
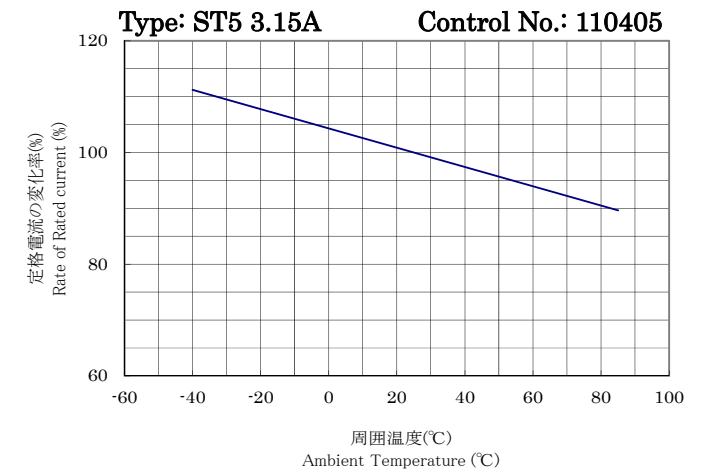
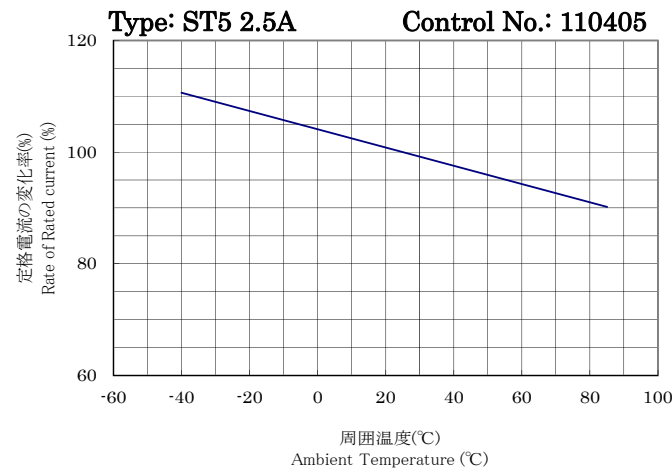
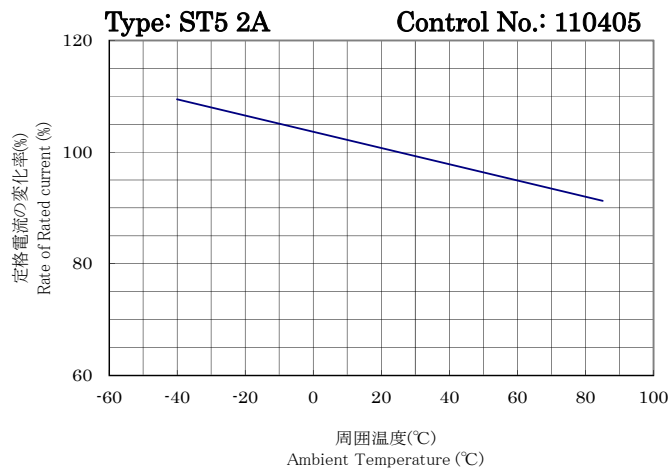

周囲温度の影響－定格電流値のリレーティング

Influence of Ambient Temperature - The Re-rating of the Rated Current

この周囲温度に対する定格電流の変化を示すグラフは、周囲温度-40℃、25℃及び85℃に於いて弊社が特定した条件で測定した3点の実測値であり、お客様での実使用条件を考慮したものではありません。ヒューズの特性はその使用条件により変化しますので、お客様にヒューズのご使用条件下で、ヒューズがお客様のご要求を満足しているかを実際にご確認頂く必要があります。

This chart is a plot of the measurements obtained at the ambient temperatures of -40℃, 25℃ and 85℃ under conditions specified by SOC. The conditions of your actual application are not considered in this chart. These data are for reference purposes only and are not intended to infer any guaranteed values. Fuse characteristics may vary depending on the usage conditions. Always test the fuse under the actual circuit conditions.

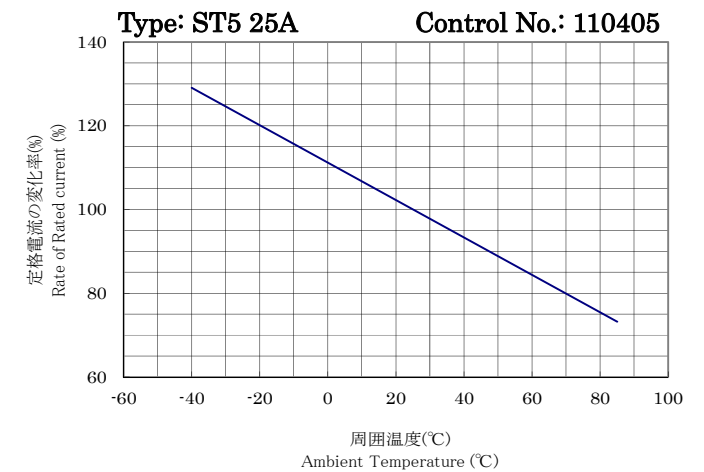
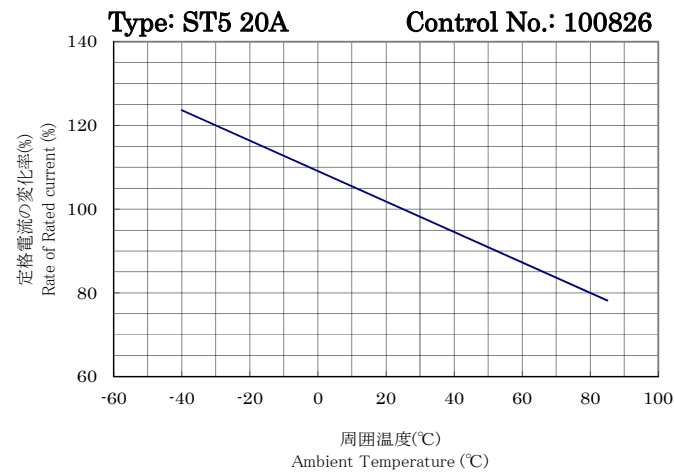
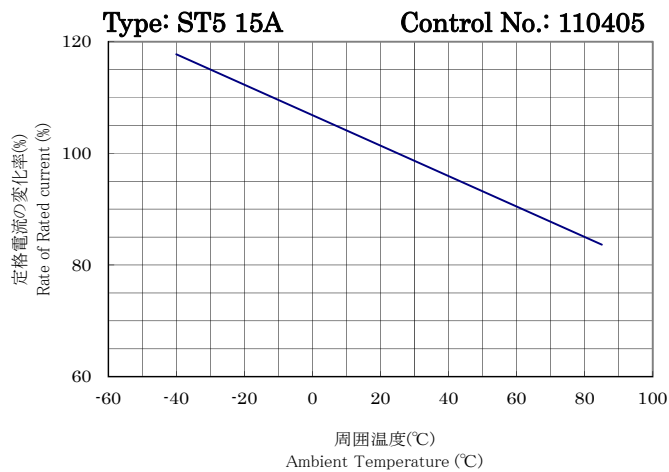
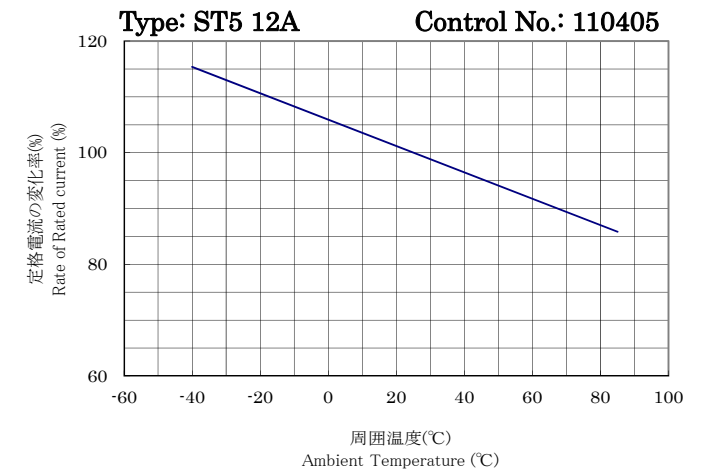
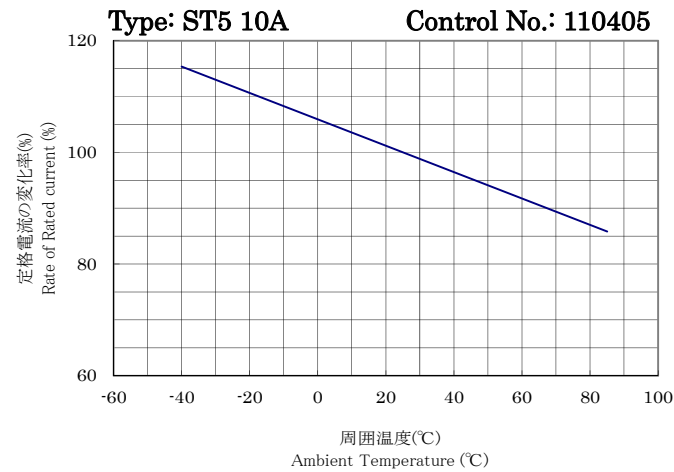
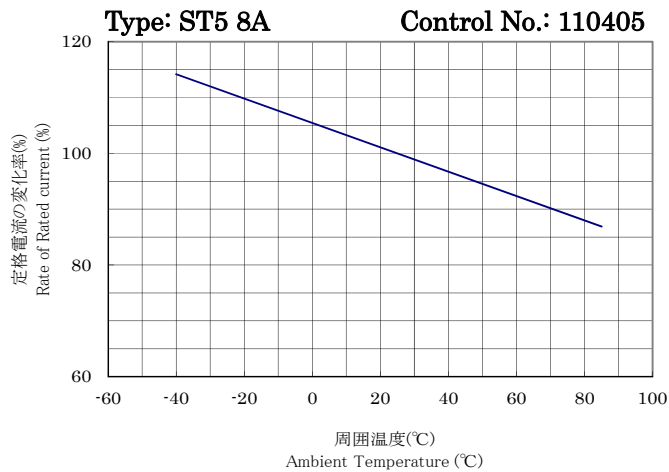

周囲温度の影響－定格電流値のリレーティング

Influence of Ambient Temperature - The Re-rating of the Rated Current

この周囲温度に対する定格電流の変化を示すグラフは、周囲温度-40 °C、25 °C 及び 85 °C に於いて弊社が特定した条件で測定した 3 点の実測値であり、お客様での実使用条件を考慮したものではありません。ヒューズの特性はその使用条件により変化しますので、お客様にヒューズのご使用条件下で、ヒューズがお客様のご要求を満足しているかを実際にご確認頂く必要があります。

This chart is a plot of the measurements obtained at the ambient temperatures of -40 °C, 25 °C and 85 °C under conditions specified by SOC. The conditions of your actual application are not considered in this chart. These data are for reference purposes only and are not intended to infer any guaranteed values. Fuse characteristics may vary depending on the usage conditions. Always test the fuse under the actual circuit conditions.

Type: ST5 30A

Control No.: 100707

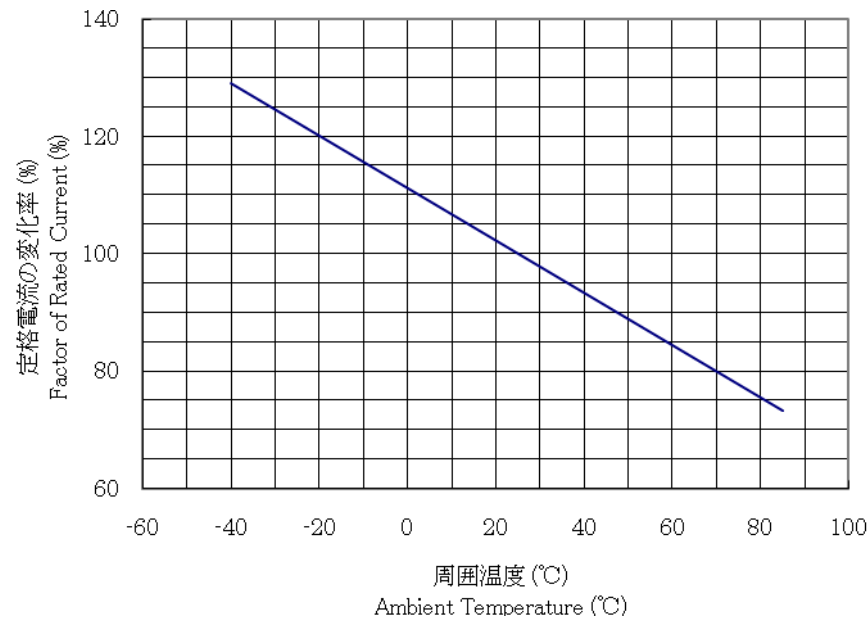

1. Construction

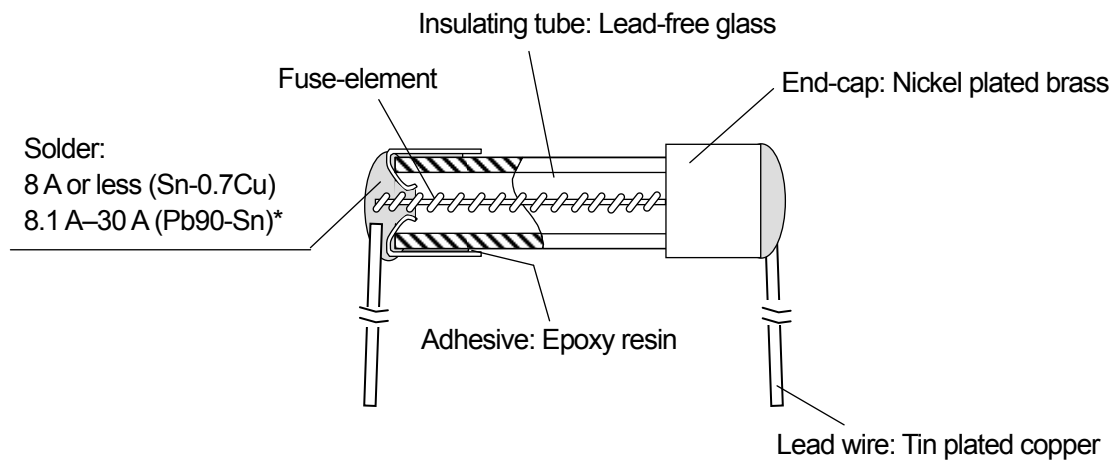

* High melting temperature type solders, containing 85 wt% or more lead, that are exempted from the EU RoHS Directive for hazardous substances are used (8.1 A–30 A).

2. Usage conditions

Ambient temperature: -40 °C–+85 °C

Note: The current carrying capacity of the fuse may vary depending on the ambient temperature.

Ambient humidity: 85% RH or less

3. Storage conditions and storage period

Products packaged as delivered can be stored for one year after shipping from SOC.

Ambient temperature: -30 °C–+40 °C (No condensation)

Ambient humidity: 85% RH or less

Ambient atmosphere: Not exposed to corrosive gas or sea breeze.

No visible dust.

Not exposed to direct sunlight.

Load: No application of load that may cause deformation or degradation of the product.

4. Typical cold resistance (for reference only)

Rated current	Typical cold resistance	Rated current	Typical cold resistance	Rated current	Typical cold resistance
100 mA	32.0 Ω	1 A	240 mΩ	8 A	11 mΩ
160 mA	10.5 Ω	1.25 A	200 mΩ	10 A	9.0 mΩ
200 mA	8.0 Ω	1.6 A	130 mΩ	12 A	7.0 mΩ
250 mA	6.0 Ω	2 A	90 mΩ	15 A	5.0 mΩ
315 mA	3.5 Ω	2.5 A	50 mΩ	20 A	3.5 mΩ
400 mA	2.4 Ω	3.15 A	36 mΩ	25 A	3.5 mΩ
500 mA	1.1 Ω	4 A	26 mΩ	30 A	2.8 mΩ
630 mA	700 mΩ	5 A	21 mΩ		
800 mA	400 mΩ	6.3 A	14 mΩ		

5. Resistance to soldering heat

The soldering conditions shown below are examples when the facilities of our company are used. These conditions may vary depending on the facilities to be used. Please evaluate a sufficient number of samples under the actual conditions in your company prior to production.

(1) Wave soldering

The soldering conditions stated below may be influenced by the material/shape and dimensions of the board, size of the copper foil, and/or heat capacity of the respective components on the board, besides such factors as temperature/duration of preheating, material of solder, temperature of the solder bath, and/or the duration of dipping.

- Length of the lead between the fuse body and the soldered surface of the board: L = 8 mm or more
- Pre-heating: 80 °C–140 °C, 30 s–60 s
- Temperature of molten solder: 260 °C or less
- Duration: 7 s or less

(2) Hand soldering with soldering iron

Depending on the components to which the fuse is attached (e.g. copper foil of the board) and/or heat capacity of the soldering iron tip, the soldering conditions may vary from those specified below.

- Length of the lead between the fuse body and the soldered surface of the board: L = 5 mm or more
- Soldering iron tip temp.: 380 °C
- Duration: 3 s or less

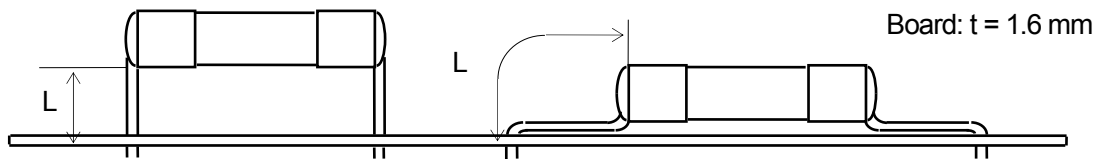

- Care must be taken not to apply any stress such as bending, twisting, rotating or tension to the lead wire and the end-cap during heating of the fuse body by soldering and while it is kept at a high temperature of 40 °C or more.
- Do not apply any stress to the lead wire while the fuse body is being held, otherwise it may cause degradation of the end-cap portion. The root of the lead wire should be held firmly when it is formed.

1. Fuses to be delivered shall be packed as follows:

- (1) 100 fuses are packed into a colorless transparent polyethylene bag.
- (2) An identification label is attached to each bag.
- (3) Each bag of 100 fuses is packed into the cardboard case shown in the figure below. If the number of fuses to be packed in is less than 100, the fuses are still packed into the case in the same manner.
- (4) The following are indicated on the surface of the cardboard case:
 - Your part number (by request)
 - Quantity of fuses
 - Packaged date
 - Country of origin
 - Manufacturer
 - Production facilities
 - Indications required by the applicable standards

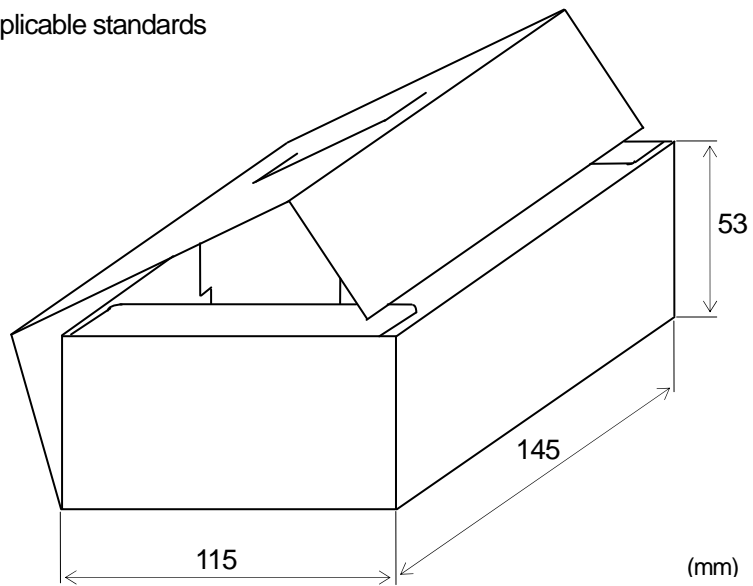

2. Lot number

The lot number indicates the following:

