

Aluminum Capacitors Axial Long Life, DIN-Based

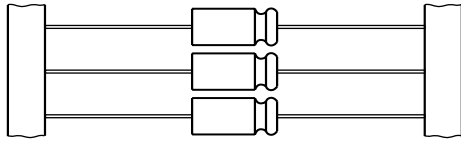
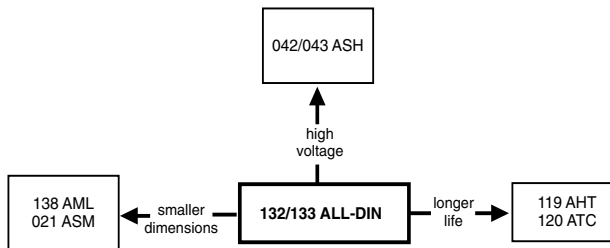

Fig.1 Component outlines



FEATURES

- Polarized aluminum electrolytic capacitors, non-solid electrolyte
- Axial leads, cylindrical aluminum case, insulated with a blue sleeve
- Mounting ring version not available in insulated form
- Taped versions up to case \varnothing 15 x 30 mm available for automatic insertion
- Charge and discharge proof
- Long useful life: up to 10 000 to 15 000 hours at 85 °C, high reliability
- Lead (Pb)-free versions are RoHS compliant



RoHS*
COMPLIANT

APPLICATIONS

- General industrial, power supplies, telecommunication, EDP
- Coupling, decoupling, timing; smoothing, filtering and buffering in SMPS
- For use where low mounting height is important
- Vibration and shock resistant

MARKING

The capacitors are marked (where possible) with the following information:

- Rated capacitance (in μ F)
- Tolerance on rated capacitance, code letter in accordance with IEC 60062 (T for - 10 to + 50 %)
- Rated voltage (in V)
- Upper category temperature (85 °C)
- Date code, in accordance with IEC 60062
- Code for factory of origin
- Name of manufacturer
- Band to indicate the negative terminal
- '+' sign to identify the positive terminal
- Series number (132 or 133)

QUICK REFERENCE DATA			
DESCRIPTION	VALUE		
Nominal case sizes (\varnothing D x L in mm)	6.5 x 18 and 8 x 18	10 x 18 and 10 x 25	10 x 30 to 21 x 38
Rated capacitance range, C_R	1 to 4700 μ F		
Tolerance on C_R	- 10 to + 50 %		
Rated voltage range, U_R	10 to 350 V		
Category temperature range	- 40 to + 85 °C		
Endurance test at 105 °C	2000 hours	2000 hours	-
Endurance test at 85 °C	6000 hours	8000 hours	8000 hours
Useful life at 105 °C	3000 hours	3000 hours	-
Useful life at 85 °C	10 000 hours	15 000 hours	15 000 hours
Useful life at 40 °C, 1.8 x I_R applied	160 000 hours	240 000 hours	240 000 hours
Shelf life at 0 V, 85 °C	500 hours		
Based on sectional specification	IEC 60384-4/EN130300		
Climatic category IEC 60068	40/085/56		

SELECTION CHART FOR C_R , U_R AND RELEVANT NOMINAL CASE SIZES (\varnothing D x L in mm)									
C_R (μ F)	U_R (V)								
	10	16	25	40	63	100	160	250	350
1.0	-	-	-	-	-	6.5 x 18	-	-	6.5 x 18
2.2	-	-	-	-	-	6.5 x 18	6.5 x 18	8 x 18	8 x 18
4.7	-	-	-	-	6.5 x 18	6.5 x 18	8 x 18	10 x 18	8 x 18
10	-	-	-	-	6.5 x 18	8 x 18	10 x 18	10 x 25	12.5 x 30 ⁽¹⁾
	-	-	-	-	-	-	-	10 x 30 ⁽¹⁾	-
22	-	-	6.5 x 18	-	8 x 18	10 x 18	10 x 25	12.5 x 30 ⁽¹⁾	15 x 30 ⁽¹⁾
	-	-	-	-	-	-	10 x 30 ⁽¹⁾	-	-

* Pb containing terminations are not RoHS compliant, exemptions may apply

SELECTION CHART FOR C_R , U_R AND RELEVANT NOMINAL CASE SIZES ($\varnothing D \times L$ in mm)									
C_R (μF)	U_R (V)								
	10	16	25	40	63	100	160	250	350
47	-	6.5 x 18	-	8 x 18	10 x 18	10 x 25	15 x 30 ⁽¹⁾	18 x 30 ⁽¹⁾	18 x 38 ⁽¹⁾
68	-	-	-	-	-	10 x 30	-	-	-
100	-	8 x 18	-	10 x 18	10 x 30	15 x 30	18 x 30 ⁽¹⁾	18 x 38 ⁽¹⁾	21 x 38 ⁽¹⁾
150	-	-	-	12.5 x 30	15 x 30	18 x 30	18 x 38 ⁽¹⁾	-	-
220	8 x 18	10 x 18	10 x 25	12.5 x 30	15 x 30	18 x 38	21 x 38 ⁽¹⁾	-	-
330	-	-	12.5 x 30	-	-	-	-	-	-
470	-	10 x 25	12.5 x 30	15 x 30	18 x 30	18 x 38	-	-	-
680	12.5 x 30	10 x 25	12.5 x 30	15 x 30	18 x 38	21 x 38	-	-	-
1000	-	12.5 x 30	-	-	-	-	-	-	-
1500	12.5 x 30	15 x 30	18 x 30	18 x 30	21 x 38	-	-	-	-
2200	15 x 30	15 x 30	18 x 30	18 x 38	21 x 38	-	-	-	-
3300	18 x 30	18 x 30	18 x 38	21 x 38	-	-	-	-	-
4700	18 x 30	18 x 38	21 x 38	21 x 38	-	-	-	-	-
4700	18 x 38	21 x 38	-	-	-	-	-	-	-
4700	21 x 38	21 x 38	-	-	-	-	-	-	-

Note

1. For these CV-values see data sheet 041-043 ASH.

DIMENSIONS in millimeters AND AVAILABLE FORMS

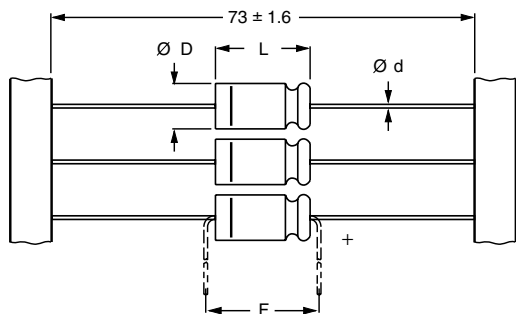

Form BR: Taped on reel,
case $\varnothing D \times L = 6.5 \times 18$ to 15×30 mm.

Form BA: Taped in box (ammopack),
case $\varnothing D \times L = 6.5 \times 18$ to 10×25 mm.

Fig.2 Forms BA and BR

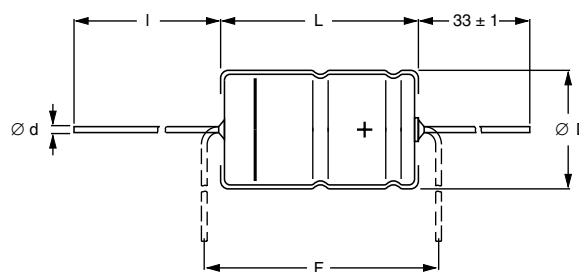

Form AA: Axial in box,
case $\varnothing D \times L = 10 \times 30$ to 21×38 mm.

Fig.3 Form AA

Table 1

AXIAL; DIMENSIONS in millimeters, MASS AND PACKAGING QUANTITIES										
NOMINAL CASE SIZE $\varnothing D \times L$	CASE CODE	AXIAL FORM AA, BA, and BR					MASS (g)	PACKAGING QUANTITIES		
		$\varnothing d$	l	$\varnothing D_{max}$	L_{max}	F_{min}		FORM AA	FORM BA	FORM BR
6.5 x 18	4	0.8	-	6.9	18.5	25	≈ 1.3	-	1000	1000
8 x 18	5	0.8	-	8.5	18.5	25	≈ 1.7	-	500	500
10 x 18	6	0.8	-	10.5	18.5	25	≈ 2.5	-	500	500
10 x 25	7	0.8	-	10.5	25.0	30	≈ 3.3	-	500	500
10 x 30	00	0.8	55 ± 1	10.5	30.5	35	≈ 4.8	340	-	500
12.5 x 30	01	0.8	55 ± 1	13.0	30.5	35	≈ 7.4	260	-	400
15 x 30	02	0.8	55 ± 1	15.5	30.5	35	≈ 11.7	200	-	250
18 x 30	03	0.8	55 ± 1	18.5	30.5	35	≈ 12.9	120	-	-
18 x 38	04	0.8	34 ± 1	18.5	39.0	44	≈ 19.0	125	-	-
21 x 38	05	0.8	34 ± 1	21.5	39.0	44	≈ 24.0	100	-	-

Note

1. Detailed tape dimensions see section 'PACKAGING'.

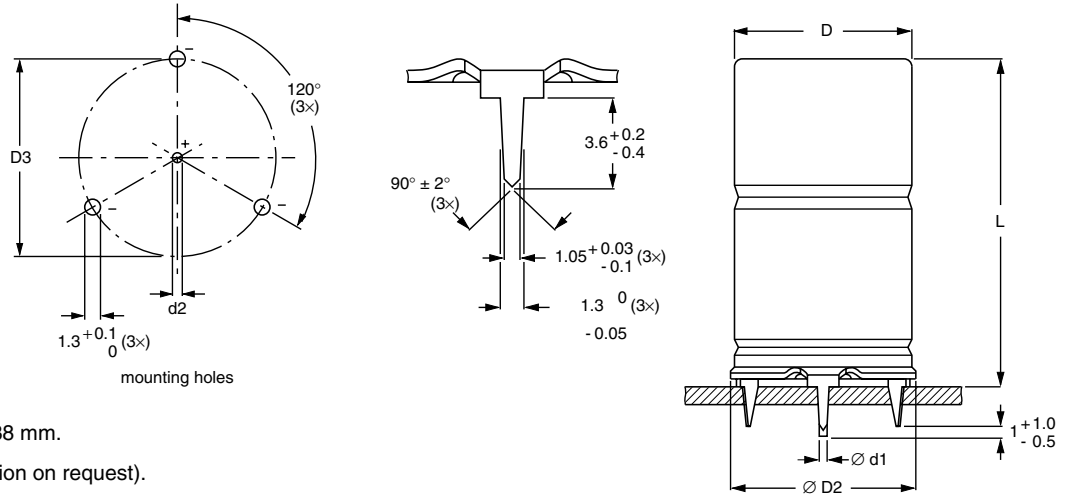
Fig.4 Mounting hole diagram and outline; **Form MR**; mounting ring and pins.

Form MR: case

 $\varnothing D \times L = 15 \times 30$ to 21×38 mm.

Case not insulated (insulation on request).

Especially for applications with severe shocks and vibrations.

Table 2

MOUNTING RING; DIMENSIONS in millimeters, MASS AND PACKAGING QUANTITIES									
NOMINAL CASE SIZE $\varnothing D \times L$	CASE CODE	MOUNTING RING: FORM MR						MASS (g)	PACKAGING QUANTITIES
		$\varnothing d1$	$\varnothing d2$	$\varnothing D_{max}$	$\varnothing D2_{max}$	D3	L_{max}		
15 x 30	02	0.8	1.0 + 0.4	15.5	17.5	16.5 ± 0.2	33	≈ 11.7	200
18 x 30	03	0.8	1.0 + 0.4	18.5	19.5	18.5 ± 0.2	33	≈ 12.9	240
18 x 38	04	0.8	1.0 + 0.4	18.5	19.5	18.5 ± 0.2	42	≈ 19.0	100
21 x 38	05	0.8	1.0 + 0.4	21.5	22.5	21.5 ± 0.2	42	≈ 24.0	100

ELECTRICAL DATA	
SYMBOL	DESCRIPTION
C_R	rated capacitance at 100 Hz, tolerance - 10/+ 50 %
I_R	rated RMS ripple current at 100 Hz, 85 °C
I_{L5}	max. leakage current after 5 minutes at U_R
Tan δ	max. dissipation factor at 100 Hz
ESR	equivalent series resistance at 100 Hz (calculated from tan δ_{max} and C_R)
Z	max. impedance at 10 kHz

ORDERING EXAMPLE*

Electrolytic capacitor 132 series

 100 μ F/40 V; - 10/+ 50 %

 Nominal case size: $\varnothing 10 \times 18$ mm; Form BR

Catalog number: 2222 132 27101

*Note: To ensure delivery of lead (Pb)-free parts during the transition period, please contact your Vishay sales agent.

Note

- Unless otherwise specified, all electrical values in Table 3 apply at $T_{amb} = 20$ °C, P = 86 to 106 kPa, RH = 45 to 75 %.



Table 3

ELECTRICAL DATA AND ORDERING INFORMATION													
U _R (V)	C _R 100 Hz (μF)	NOMINAL CASE SIZE ∅ D x L (mm)	I _R 100 Hz 85 °C (mA)	I _{L5} 5 min (μA)	Tan δ 100 Hz	ESR 100 Hz (Ω)	Z 10 kHz (Ω)	Z 100 kHz (Ω)	CATALOG NUMBER 2222				
									IN BOX FORM AA	TAPED ON REEL FORM BR	TAPED IN BOX FORM BA	MOUNTING RING FORM MR	
10	220	8 x 18	190	8.4	0.18	1.3	0.73	0.70	-	132 24221	132 34221	-	-
	470	12.5 x 30	350	9.4	0.18	0.61	0.26	0.60	132 14471	132 24471	-	-	
	680	12.5 x 30	460	13.6	0.18	0.42	0.20	0.40	132 14681	132 24681	-	-	
	1000	15 x 30	640	20	0.18	0.28	0.12	-	132 14102	132 24102	-	132 44102	
	1500	18 x 30	800	30	0.22	0.23	0.10	-	132 14152	-	-	132 44152	
	2200	18 x 30	1100	44	0.22	0.16	0.09	-	132 14222	-	-	132 44222	
	3300	18 x 38	1300	66	0.27	0.13	0.05	-	132 14332	-	-	132 44332	
	4700	21 x 38	1800	94	0.27	0.09	0.05	-	132 14472	-	-	132 44472	
	16	47	6.5 x 18	95	5.5	0.14	4.7	2.6	2.2	-	132 25479	132 35479	-
100		8 x 18	150	7.2	0.14	2.2	1.2	1.1	-	132 25101	132 35101	-	-
220		10 x 18	250	11	0.14	1.0	0.55	0.55	-	132 25221	132 35221	-	-
330		10 x 25	320	14.6	0.14	0.67	0.36	0.36	-	132 90508	132 90509	-	-
330		12.5 x 30	320	10.6	0.14	0.67	0.36	0.60	132 15331	132 25331	-	-	
470		10 x 25	450	19	0.14	0.47	0.26	0.26	-	132 90507	132 90502	-	-
470		12.5 x 30	450	15	0.14	0.47	0.26	0.40	132 15471	132 25471	-	-	
680		15 x 30	550	22	0.14	0.33	0.14	-	132 15681	132 25681	-	132 45681	
1000		15 x 30	780	32	0.14	0.22	0.12	-	132 15102	132 25102	-	132 45102	
1500		18 x 30	950	48	0.15	0.16	0.10	-	132 15152	-	-	132 45152	
2200		18 x 38	1300	70	0.15	0.11	0.06	-	132 15222	-	-	132 45222	
3300		21 x 38	1600	110	0.15	0.07	0.05	-	132 15332	-	-	132 45332	
4700		21 x 38	2300	150	0.15	0.05	0.05	-	132 15472	-	-	132 45472	
25	22	6.5 x 18	60	5.1	0.11	8.0	4.1	2.9	-	132 26229	132 36229	-	-
	220	10 x 25	340	15	0.11	0.8	0.40	0.40	-	132 90503	132 90504	-	-
	220	12.5 x 30	340	11	0.11	0.8	0.40	0.60	132 16221	132 26221	-	-	
	330	12.5 x 30	410	16.5	0.11	0.53	0.30	0.40	132 16331	132 26331	-	-	
	470	12.5 x 30	560	24	0.11	0.37	0.20	-	132 16471	132 26471	-	-	
	680	18 x 30	700	34	0.11	0.26	0.10	-	132 16681	-	-	132 46681	
	1000	18 x 30	1000	50	0.11	0.17	0.10	-	132 16102	-	-	132 46102	
	1500	18 x 38	1100	75	0.12	0.13	0.06	-	132 16152	-	-	132 46152	
2200	21 x 38	1850	110	0.13	0.09	0.05	-	132 16222	-	-	132 46222		
40	47	8 x 18	120	7.8	0.09	3.0	1.6	1.4	-	132 27479	132 37479	-	-
	100	10 x 18	210	12	0.09	1.4	0.75	0.75	-	132 27101	132 37101	-	-
	150	10 x 25	310	16	0.09	0.95	0.50	0.50	-	132 90511	132 90512	-	-
	150	12.5 x 30	310	12	0.09	0.95	0.50	0.60	132 17151	132 27151	-	-	
	220	12.5 x 30	410	17.5	0.09	0.65	0.34	0.40	132 17221	132 27221	-	-	
	330	15 x 30	550	26	0.09	0.43	0.20	-	132 17331	132 27331	-	132 47331	
	470	15 x 30	700	38	0.09	0.30	0.16	-	132 17471	132 27471	-	132 47471	
	680	18 x 30	900	54	0.09	0.21	0.10	-	132 17681	-	-	132 47681	
	1000	18 x 38	1200	80	0.09	0.14	0.08	-	132 17102	-	-	132 47102	
	1500	21 x 38	1500	120	0.10	0.10	0.06	-	132 17152	-	-	132 47152	
2200	21 x 38	1900	180	0.10	0.07	0.05	-	132 17222	-	-	132 47222		
63	4.7	6.5 x 18	38	4.6	0.07	24	12	5	-	132 28478	132 38478	-	-
	10	6.5 x 18	64	5.3	0.07	11	5.5	3.3	-	132 28109	132 38109	-	-
	22	8 x 18	100	6.8	0.07	5.1	2.5	2.1	-	132 28229	132 38229	-	-
	47	10 x 18	170	9.9	0.07	2.4	1.2	1.2	-	132 28479	132 38479	-	-
	68	10 x 25	210	12.6	0.07	1.6	0.81	0.60	-	132 90513	132 90514	-	-
	68	10 x 30	210	8.6	0.07	1.6	0.80	0.60	132 18689	132 28689	-	-	
	100	10 x 30	300	12.6	0.07	1.1	0.60	0.40	132 18101	132 28101	-	-	
	150	15 x 30	350	19	0.07	0.74	0.37	-	132 18151	132 28151	-	132 48151	
	220	15 x 30	520	28	0.07	0.50	0.25	-	132 18221	132 28221	-	132 48221	
	330	18 x 30	600	42	0.07	0.34	0.15	-	132 18331	-	-	132 48331	
	470	18 x 38	970	59	0.07	0.24	0.12	-	132 18471	-	-	132 48471	
	680	21 x 38	1000	86	0.07	0.16	0.08	-	132 18681	-	-	132 48681	
	1000	21 x 38	1600	130	0.07	0.11	0.06	-	132 18102	-	-	132 48102	



ELECTRICAL DATA AND ORDERING INFORMATION												
U _R (V)	C _R 100 Hz (μF)	NOMINAL CASE SIZE ∅ D x L (mm)	I _R 100 Hz 85 °C (mA)	I _{L5} 5 min (μA)	Tan δ 100 Hz	ESR 100 Hz (Ω)	Z 10 kHz (Ω)	Z 100 kHz (Ω)	CATALOG NUMBER 2222			
									IN BOX FORM AA	TAPED ON REEL FORM BR	TAPED IN BOX FORM BA	MOUNTING RING FORM MR
100	1	6.5 x 18	20	4.0	0.06	95	45	6	-	132 29108	132 39108	-
	2.2	6.5 x 18	30	4.4	0.06	43	20	5	-	132 29228	132 39228	-
	4.7	6.5 x 18	48	4.9	0.06	20	9.6	4	-	132 29478	132 39478	-
	10	8 x 18	73	6	0.06	9.5	4.5	2.8	-	132 29109	132 39109	-
	22	10 x 18	130	8.4	0.06	4.3	2	1.3	-	132 29229	132 39229	-
	47	10 x 25	220	13.4	0.06	2.0	1	0.90	-	132 90505	132 90506	-
	47	10 x 30	220	9.4	0.06	2.0	1	0.90	132 19479	132 29479	-	-
	68	12.5 x 30	250	13.5	0.06	1.4	0.80	-	132 19689	132 29689	-	-
	100	15 x 30	380	20	0.06	0.95	0.50	-	132 19101	132 29101	-	132 49101
	150	18 x 30	400	30	0.06	0.64	0.35	-	132 19151	-	-	132 49151
	220	18 x 38	660	44	0.06	0.43	0.20	-	132 19221	-	-	132 49221
	330	18 x 38	700	66	0.06	0.29	0.15	-	132 19331	-	-	132 49331
470	21 x 38	1200	94	0.06	0.20	0.10	-	132 19471	-	-	132 49471	
160	2.2	6.5 x 18	22	20	0.10	72	55	30	-	133 21228	133 31228	-
	4.7	8 x 18	37	20	0.10	34	26	20	-	133 21478	133 31478	-
	10	10 x 18	61	20	0.10	16	12	10	-	133 21109	133 31109	-
	22	10 x 25	120	20	0.10	7.2	5.5	2.5	-	133 90502	133 90503	-
250	2.2	8 x 18	25	20	0.10	72	50	30	-	133 23228	133 33228	-
	4.7	10 x 18	37	20	0.10	34	23	16	-	133 23478	133 33478	-
	10	10 x 25	66	20	0.10	16	11	9	-	133 23109	133 33109	-
350	1	6.5 x 18	15	20	0.10	160	100	40	-	133 25108	133 35108	-
	2.2	8 x 18	25	20	0.10	72	45	28	-	133 25228	133 35228	-
	4.7	8 x 18	43	20	0.10	34	21	15	-	133 90511	133 90509	-

ADDITIONAL ELECTRICAL DATA			
PARAMETER	CONDITIONS	VALUE	
		AXIAL	MOUNTING RING
Voltage			
Surge voltage	U _R = 10 to 250 V	U _s ≤ 1.15 x U _R	
	U _R = 350 V	U _s ≤ 1.1 x U _R	
Reverse voltage		U _{rev} ≤ 1 V	
Current			
Leakage current	after 1 minute: case ∅ D x L = 6.5 x 18 to 10 x 25 mm: U _R = 10 to 100 V U _R = 160 to 350 V case ∅ D x L = 10 x 30 to 21 x 38 mm: U _R = 10 to 100 V	I _{L1} ≤ 0.01 C _R x U _R + 3 I _{L1} ≤ 50 μA	
	after 5 minutes: case ∅ D x L = 6.5 x 18 to 10 x 25 mm: U _R = 10 to 100 V U _R = 160 to 350 V case ∅ D x L = 10 x 30 to 21 x 38 mm: U _R = 10 to 100 V	I _{L5} ≤ 0.002 C _R x U _R + 4 I _{L5} ≤ 20 μA	
Inductance			
Equivalent series inductance (ESL)	case ∅ D x L mm:		
	6.5 x 18	typ. 15 nH	-
	8 x 18	typ. 35 nH	-
	10 x 18	typ. 69 nH	-
	10 x 25	typ. 38 nH	-
	10 x 30	typ. 38 nH	-
	12.5 x 30	typ. 46 nH	-
	15 x 30	typ. 48 nH	typ. 39 nH
	18 x 30	typ. 50 nH	typ. 39 nH
	18 x 38	typ. 54 nH	typ. 39 nH
	21 x 38	typ. 59 nH	typ. 39 nH

CAPACITANCE (C)

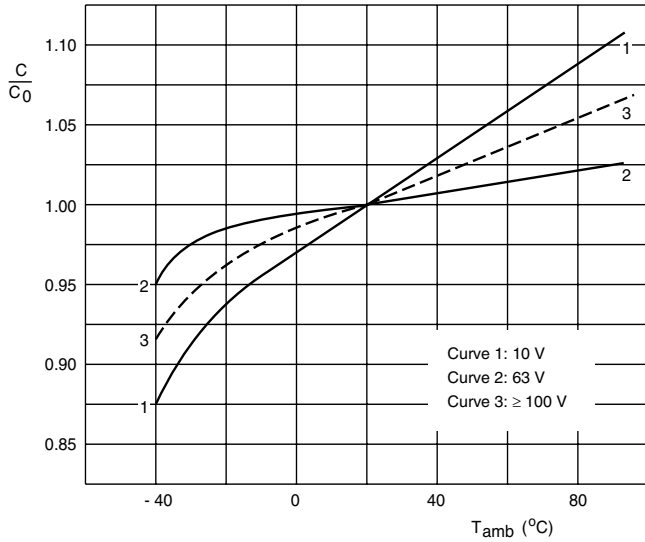

C_0 = capacitance at 20 °C, 100 Hz

Fig.5 Typical multiplier of capacitance as a function of ambient temperature

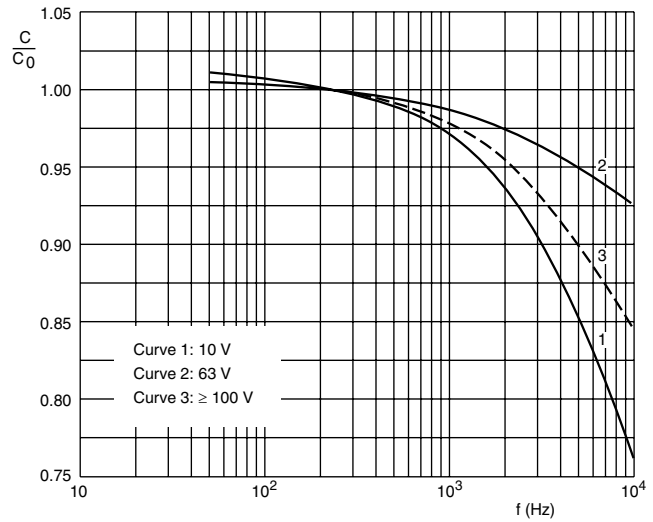

C_0 = capacitance at 20 °C, 100 Hz

Fig.6 Typical multiplier of capacitance as a function of frequency

DISSIPATION FACTOR ($\tan \delta$)

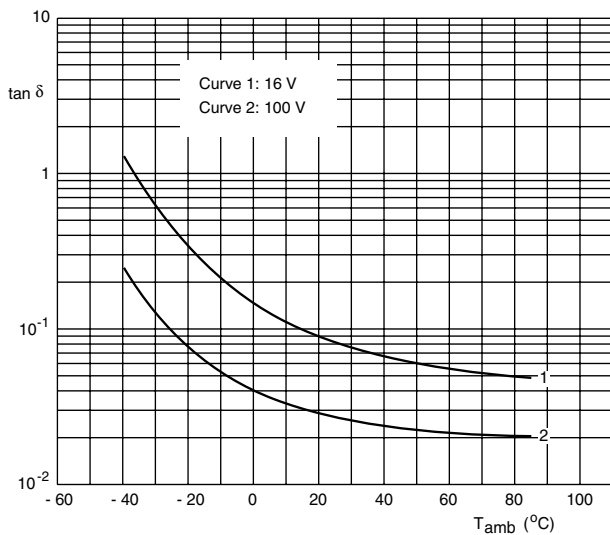

Case $\varnothing D \times L = 6.5 \times 18$ to 10×25 mm

$f = 100$ Hz

Fig.7 Typical $\tan \delta$ as a function of ambient temperature

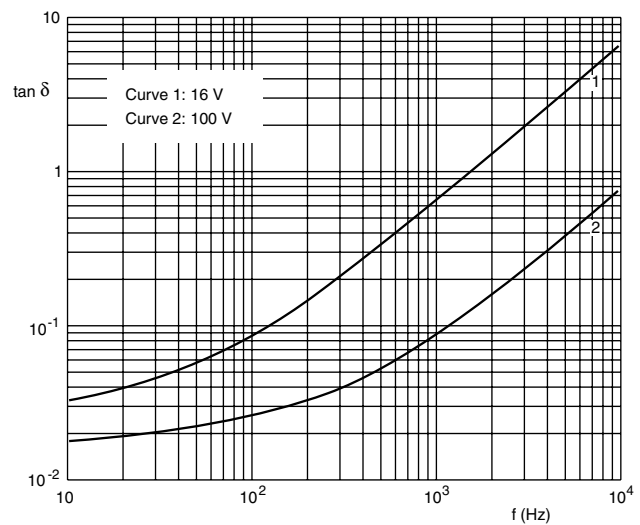

Case $\varnothing D \times L = 6.5 \times 18$ to 10×25 mm

Fig.8 Typical $\tan \delta$ as a function of frequency

IMPEDANCE (Z)

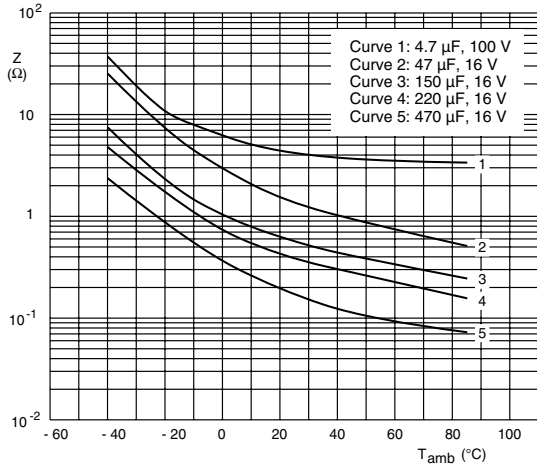

Case \varnothing D x L = 6.5 x 18 mm to 10 x 25 mm $f = 10$ kHz

Fig.9 Typical impedance as a function of ambient temperature

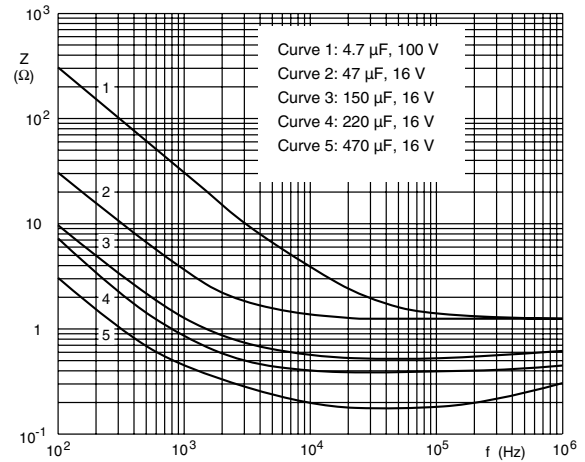

Case \varnothing D x L = 6.5 x 18 mm to 10 x 25 mm $T_{\text{amb}} = 20$ °C

Fig.10 Typical impedance as a function of frequency

RIPPLE CURRENT AND USEFUL LIFE

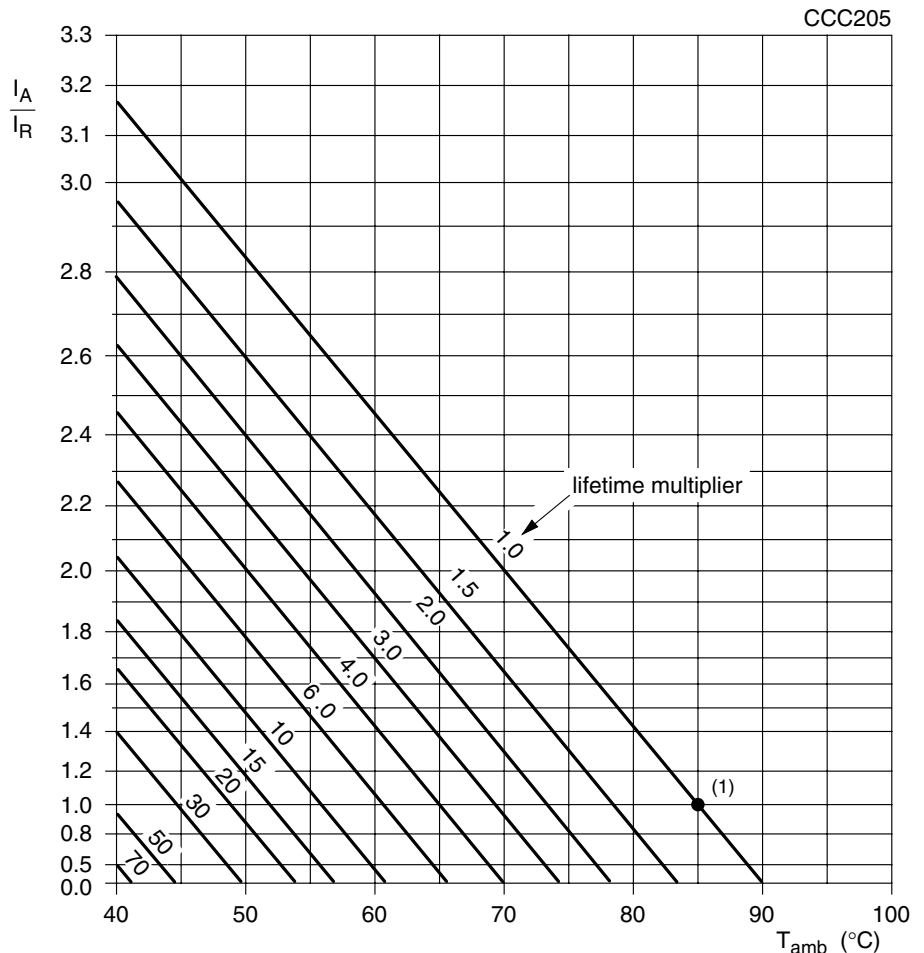

I_A = actual ripple current at 100 Hz

I_R = rated ripple current at 100 Hz, 85 °C

(1) Useful life at 85 °C and I_R applied:
 case \varnothing D x L = 6.5 x 18 to 8 x 18 mm: 10000 hours
 case \varnothing D x L = 10 x 18 to 21 x 38 mm: 15000 hours

Fig.11 Multiplier of useful life as a function of ambient temperature and ripple current load

Table 4

MULTIPLIER OF RIPPLE CURRENT (I_R) AS A FUNCTION OF FREQUENCY			
FREQUENCY (Hz)	I_R MULTIPLIER		
	$U_R = 10$ and 16 V	$U_R = 25$ and 63 V	$U_R = 100$ to 350 V
50	0.95	0.90	0.85
100	1.00	1.00	1.00
300	1.07	1.12	1.20
1000	1.12	1.20	1.30
3000	1.15	1.25	1.35
≥ 10000	1.20	1.30	1.40

Table 5

TEST PROCEDURES AND REQUIREMENTS			
TEST		PROCEDURE (quick reference)	REQUIREMENTS
NAME OF TEST	REFERENCE		
Endurance	IEC 60384-4/ EN130300 subclause 4.13	$T_{amb} = 85\text{ }^\circ\text{C}$; U_R applied; case $\varnothing D \times L = 6.5 \times 18$ to 8×18 mm: 6000 hours; case $\varnothing D \times L = 10 \times 18$ to 21×38 mm: 8000 hours	$U_R = 10$ to 160 V; $\Delta C/C: \pm 15\%$ $U_R = 250$ to 350 V; $\Delta C/C: \pm 10\%$ $\tan \delta \leq 1.3 \times \text{spec. limit}$ $Z \leq 2 \times \text{spec. limit}$ $I_{L5} \leq \text{spec. limit}$
Useful life	CECC 30301 subclause 1.8.1	$T_{amb} = 85\text{ }^\circ\text{C}$; U_R and I_R applied; case $\varnothing D \times L = 6.5 \times 18$ to 8×18 mm: 10 000 hours; case $\varnothing D \times L = 10 \times 18$ to 21×38 mm: 15 000 hours	$U_R = 10$ to 160 V; $\Delta C/C: \pm 45\%$ $U_R = 250$ to 350 V; $\Delta C/C: \pm 30\%$ $\tan \delta \leq 3 \times \text{spec. limit}$ $Z \leq 3 \times \text{spec. limit}$ $I_{L5} \leq \text{spec. limit}$ no short or open circuit total failure percentage: $\leq 1\%$
Shelf life (storage at high temperature)	IEC 60384-4/ EN130300 subclause 4.17	$T_{amb} = 85\text{ }^\circ\text{C}$; no voltage applied; 500 hours; after test: U_R to be applied for 30 minutes, 24 to 48 hours before measurement	$\Delta C/C$, $\tan \delta$, Z : for requirements see 'Endurance test' above $I_{L5} \leq 2 \times \text{spec. limit}$



Notice

Specifications of the products displayed herein are subject to change without notice. Vishay Intertechnology, Inc., or anyone on its behalf, assumes no responsibility or liability for any errors or inaccuracies.

Information contained herein is intended to provide a product description only. No license, express or implied, by estoppel or otherwise, to any intellectual property rights is granted by this document. Except as provided in Vishay's terms and conditions of sale for such products, Vishay assumes no liability whatsoever, and disclaims any express or implied warranty, relating to sale and/or use of Vishay products including liability or warranties relating to fitness for a particular purpose, merchantability, or infringement of any patent, copyright, or other intellectual property right.

The products shown herein are not designed for use in medical, life-saving, or life-sustaining applications. Customers using or selling these products for use in such applications do so at their own risk and agree to fully indemnify Vishay for any damages resulting from such improper use or sale.