

LO T776

TOPLED® Reverse Gullwing



Applications

- Electronic Equipment

Features:

- Package: white SMT package, colorless clear resin
- Chip technology: InGaAlP
- Typ. Radiation: 120° (Lambertian emitter)
- Color: $\lambda_{\text{dom}} = 606 \text{ nm}$ (● orange)
- Corrosion Robustness Class: 3B
- ESD: 2 kV acc. to ANSI/ESDA/JEDEC JS-001 (HBM)

Ordering Information

Type	Luminous Intensity ¹⁾ $I_F = 20 \text{ mA}$ I_v	Ordering Code
LO T776-Q2T1-24	90 ... 355 mcd	Q65110A2219

Maximum Ratings

Parameter	Symbol		Values
Operating Temperature	T_{op}	min. max.	-40 °C 100 °C
Storage Temperature	T_{stg}	min. max.	-40 °C 100 °C
Junction Temperature	T_j	max.	125 °C
Forward current $T_s = 25\text{ °C}$	I_F	max.	30 mA
Surge Current $t \leq 10\ \mu\text{s}$; $D = 0.005$; $T_s = 25\text{ °C}$	I_{FS}	max.	500 mA
Reverse voltage ²⁾ $T_s = 25\text{ °C}$	V_R	max.	12 V
ESD withstand voltage acc. to ANSI/ESDA/JEDEC JS-001 (HBM)	V_{ESD}		2 kV

Characteristics

$I_F = 20 \text{ mA}$; $T_S = 25 \text{ °C}$

Parameter	Symbol		Values
Peak Wavelength	λ_{peak}	typ.	610 nm
Dominant Wavelength ³⁾ $I_F = 20 \text{ mA}$	λ_{dom}	min. typ. max.	600 nm 606 nm 609 nm
Spectral Bandwidth at 50% $I_{\text{rel,max}}$	$\Delta\lambda$	typ.	16 nm
Viewing angle at 50 % I_V	2φ	typ.	120 °
Forward Voltage ⁴⁾ $I_F = 20 \text{ mA}$	V_F	min. typ. max.	1.85 V 2.00 V 2.35 V
Reverse current ²⁾ $V_R = 12 \text{ V}$	I_R	typ. max.	0.01 μA 10 μA
Temperature Coefficient of Peak Wavelength $-10^\circ\text{C} \leq T \leq 100^\circ\text{C}$	$\text{TC}_{\lambda_{\text{peak}}}$	typ.	0.13 nm / K
Temperature Coefficient of Dominant Wavelength $-10^\circ\text{C} \leq T \leq 100^\circ\text{C}$	$\text{TC}_{\lambda_{\text{dom}}}$	typ.	0.07 nm / K
Temperature Coefficient of Forward Voltage $-10^\circ\text{C} \leq T \leq 100^\circ\text{C}$	TC_{V_F}	typ.	-1.7 mV / K
Real thermal resistance junction/ambient ^{5), 6)}	$R_{\text{thJA real}}$	max.	500 K / W
Real thermal resistance junction/solderpoint ⁵⁾	$R_{\text{thJS real}}$	max.	280 K / W

Brightness Groups

Group	Luminous Intensity ¹⁾ $I_F = 20 \text{ mA}$ min. I_v	Luminous Intensity ¹⁾ $I_F = 20 \text{ mA}$ max. I_v	Luminous Flux ⁷⁾ $I_F = 20 \text{ mA}$ typ. Φ_v
Q2	90 mcd	112 mcd	300 mlm
R1	112 mcd	140 mcd	380 mlm
R2	140 mcd	180 mcd	480 mlm
S1	180 mcd	224 mcd	610 mlm
S2	224 mcd	280 mcd	760 mlm
T1	280 mcd	355 mcd	950 mlm

Wavelength Groups

Group	Dominant Wavelength ³⁾ $I_F = 20 \text{ mA}$ min. λ_{dom}	Dominant Wavelength ³⁾ $I_F = 20 \text{ mA}$ max. λ_{dom}
2	600 nm	603 nm
3	603 nm	606 nm
4	606 nm	609 nm

Group Name on Label

Example: Q2-2

Brightness	Wavelength
Q2	2

Relative Spectral Emission ⁷⁾

$I_{rel} = f(\lambda); I_F = 20 \text{ mA}; T_S = 25 \text{ }^\circ\text{C}$

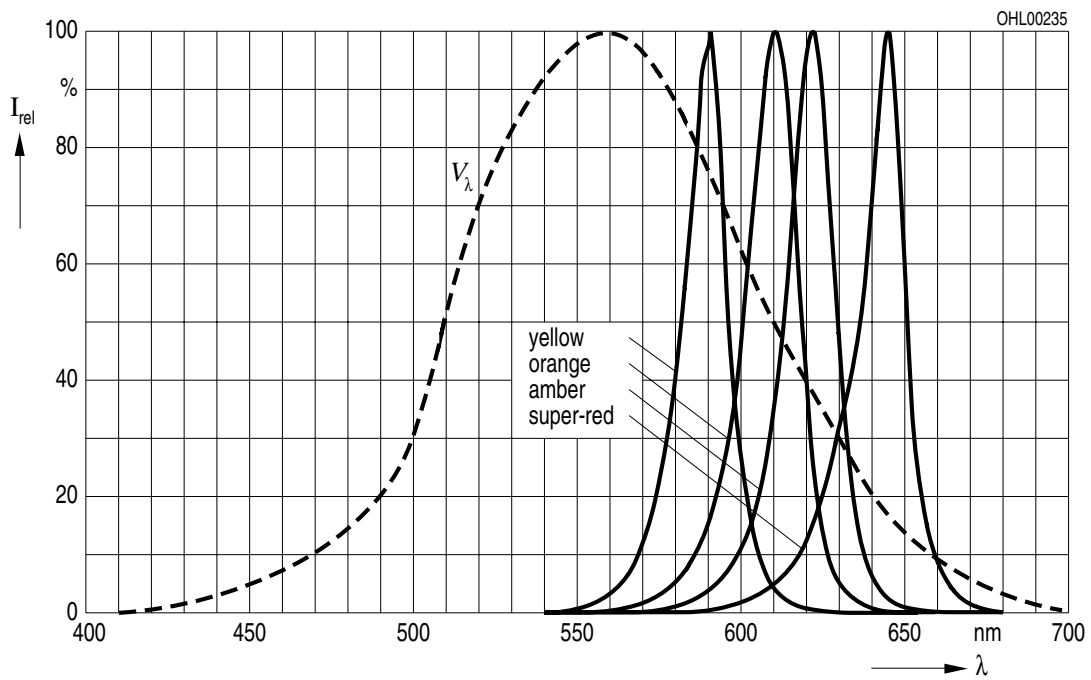

Radiation Characteristics ⁷⁾

$I_{rel} = f(\phi); T_S = 25 \text{ }^\circ\text{C}$

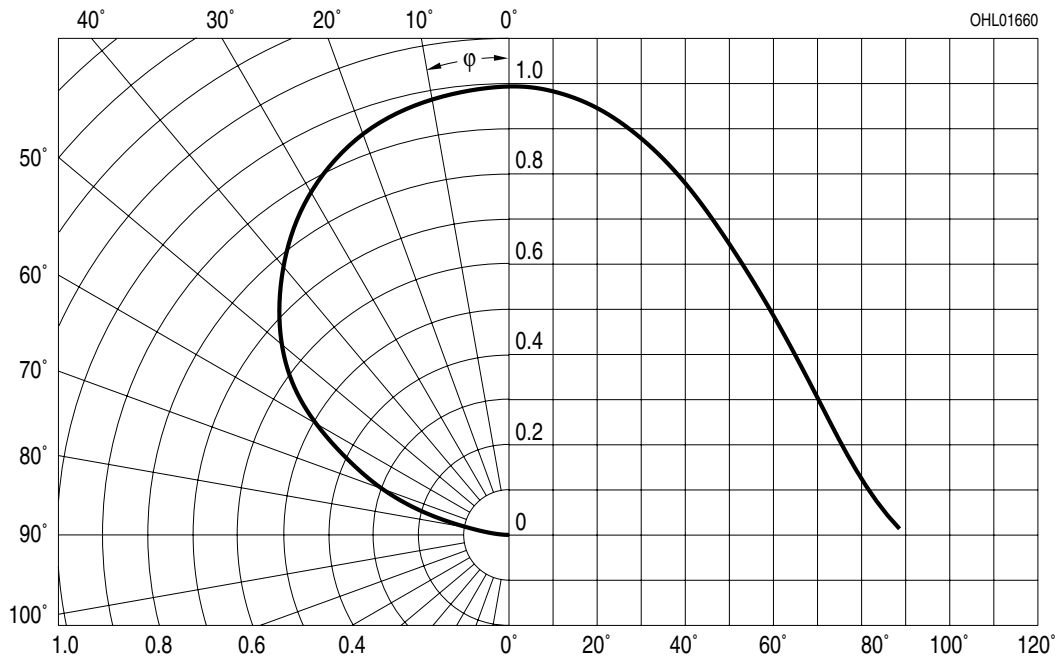

Not for new design

Forward current ⁷⁾

$$I_F = f(V_F); T_S = 25 \text{ }^\circ\text{C}$$

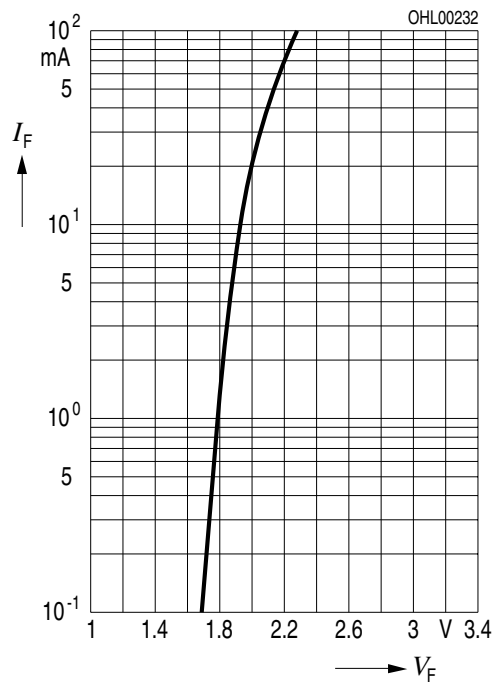

Relative Luminous Intensity ^{7), 8)}

$$I_V/I_V(20 \text{ mA}) = f(I_F); T_S = 25 \text{ }^\circ\text{C}$$

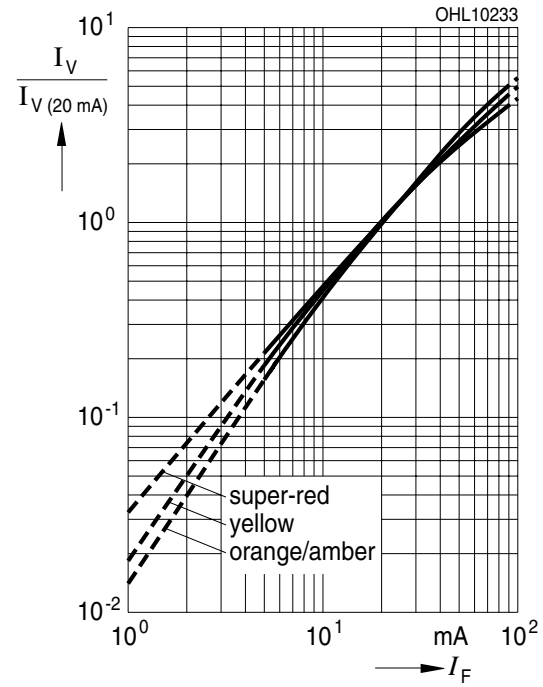

Not for new design

Relative Luminous Intensity ⁷⁾

$$I_V/I_V(25\text{ °C}) = f(T_j); I_F = 20\text{ mA}$$

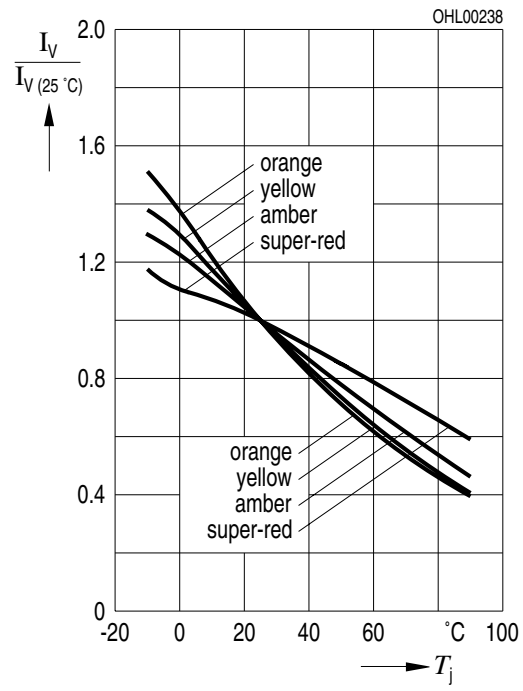

Max. Permissible Forward Current

$I_F = f(T)$

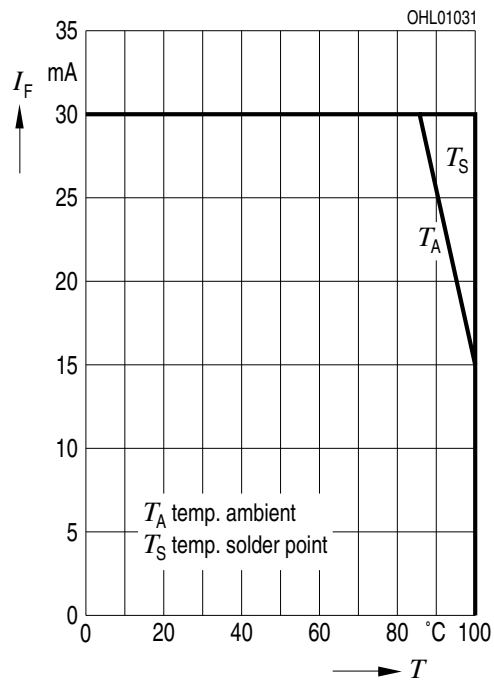

Permissible Pulse Handling Capability

$I_F = f(t_p)$; D: Duty cycle; $T_S = 25\text{ °C}$

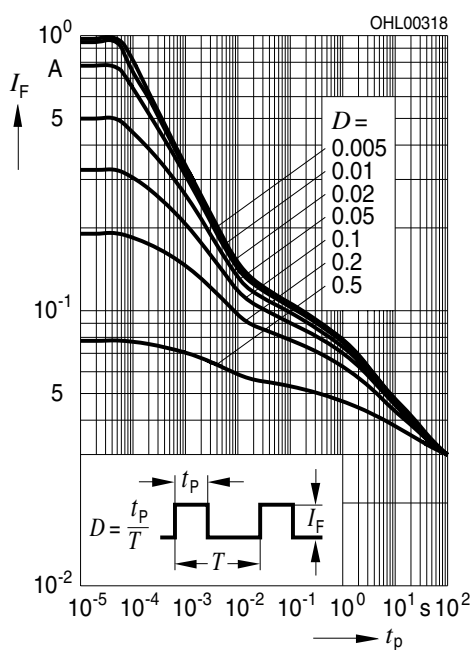

Permissible Pulse Handling Capability

$I_F = f(t_p)$; D: Duty cycle; $T_S = 85\text{ °C}$

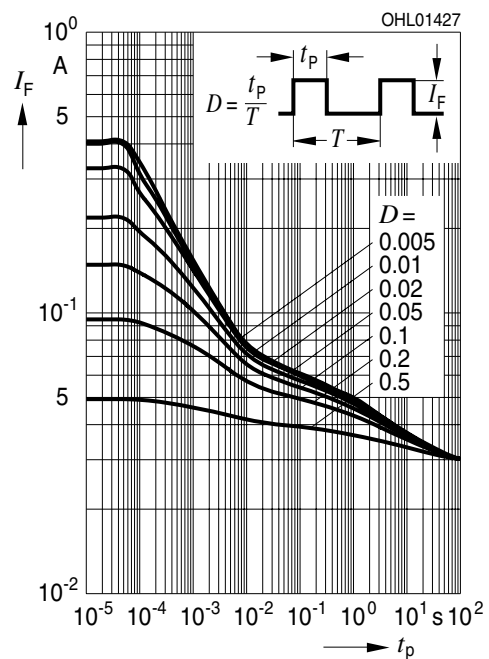

Not for new design

Dimensional Drawing ⁹⁾

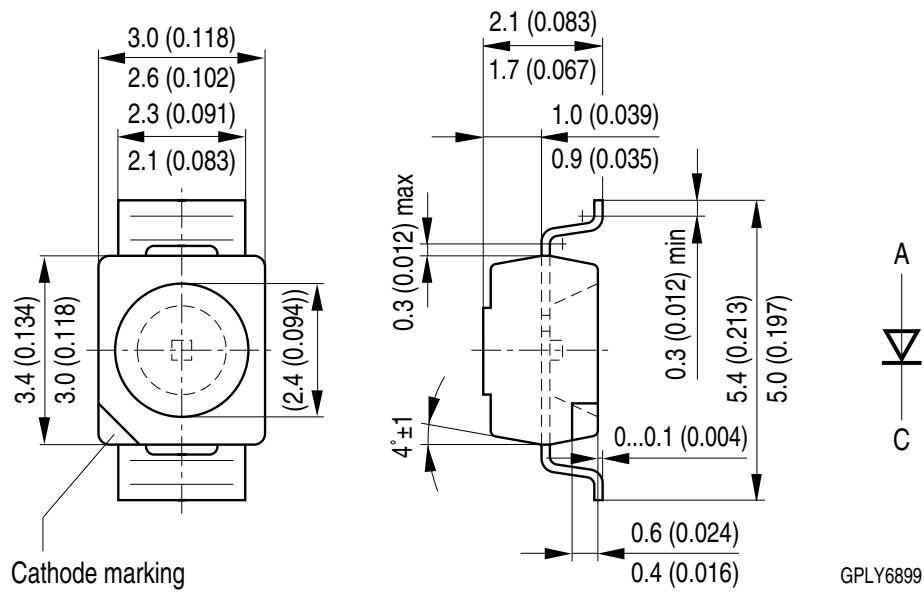

GPLY6899

Approximate Weight: 34.0 mg

Package marking: Cathode

Corrosion test: Class: 3B
 Test condition: 40°C / 90 % RH / 15 ppm H₂S / 14 days (stricter than IEC 60068-2-43)

Recommended Solder Pad ⁹⁾

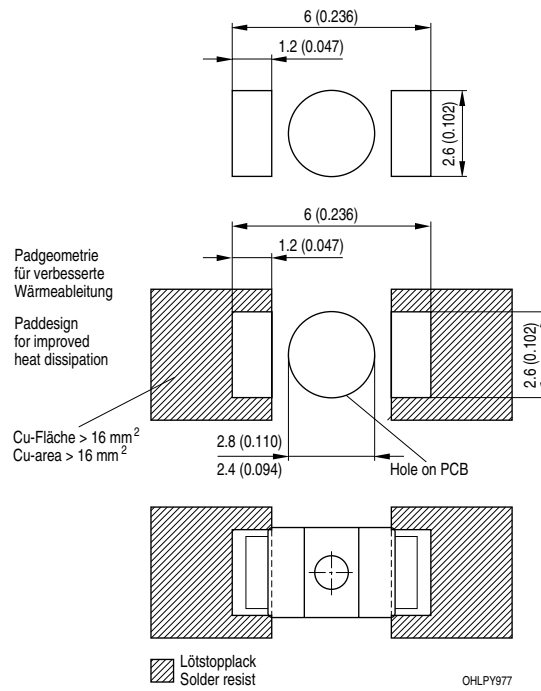

For superior solder joint connectivity results we recommend soldering under standard nitrogen atmosphere. Package not suitable for ultra sonic cleaning.

Reflow Soldering Profile

Product complies to MSL Level 2 acc. to JEDEC J-STD-020E

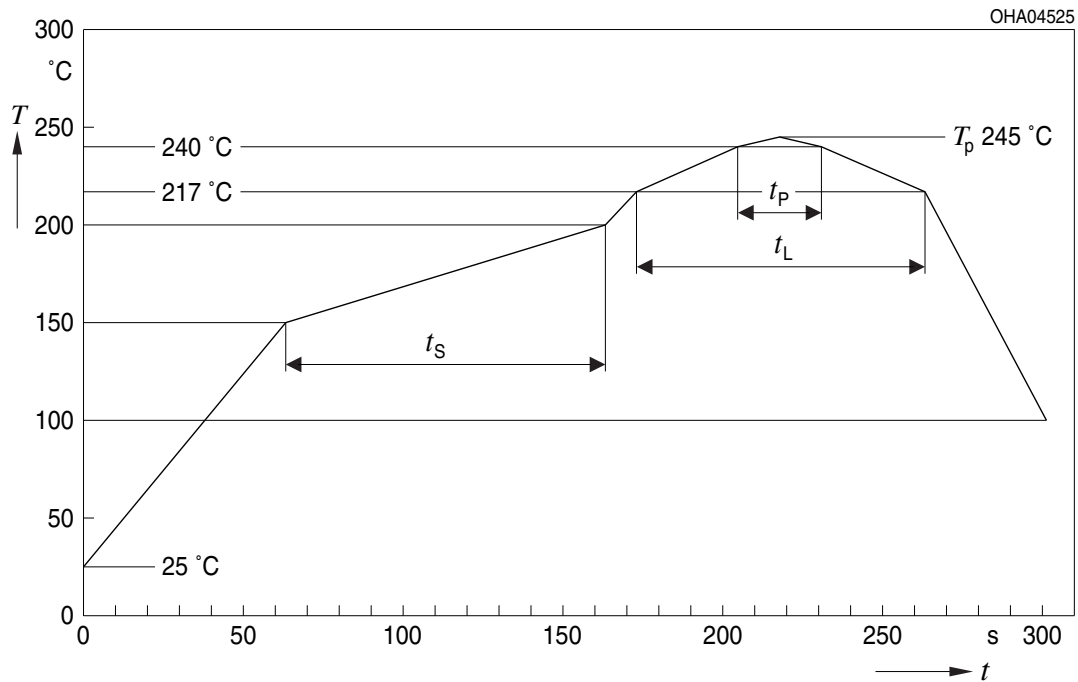

Profile Feature	Symbol	Pb-Free (SnAgCu) Assembly			Unit
		Minimum	Recommendation	Maximum	
Ramp-up rate to preheat*) 25 °C to 150 °C			2	3	K/s
Time t_s T_{Smin} to T_{Smax}	t_s	60	100	120	s
Ramp-up rate to peak*) T_{Smax} to T_p			2	3	K/s
Liquidus temperature	T_L		217		°C
Time above liquidus temperature	t_L		80	100	s
Peak temperature	T_p		245	250	°C
Time within 5 °C of the specified peak temperature $T_p - 5\text{ K}$	t_p	10	20	30	s
Ramp-down rate* T_p to 100 °C			3	4	K/s
Time 25 °C to T_p				480	s

All temperatures refer to the center of the package, measured on the top of the component
 *) slope calculation DT/Dt : Dt max. 5 s; fulfillment for the whole T-range

Not for new design

Taping ⁹⁾

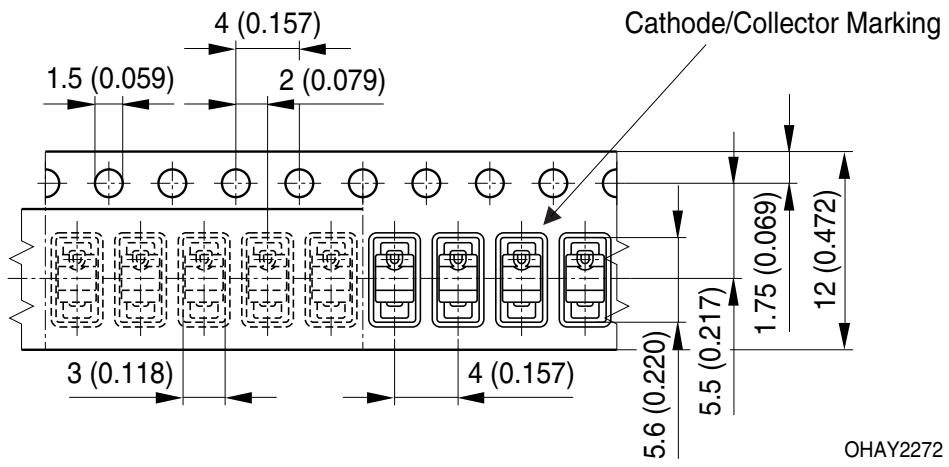

Not for new design

Tape and Reel ¹⁰⁾



Reel dimensions [mm]

A	W	N _{min}	W ₁	W _{2max}	Pieces per PU
180 mm	12 + 0.3 / - 0.1	60	12.4 + 2	18.4	2000
330 mm	12 + 0.3 / - 0.1	60	12.4 + 2	18.4	8000

Barcode-Product-Label (BPL)



Dry Packing Process and Materials ⁹⁾



Moisture-sensitive product is packed in a dry bag containing desiccant and a humidity card according JEDEC-STD-033.

Transportation Packing and Materials ⁹⁾



Dimensions of transportation box in mm

Width	Length	Height
195 ± 5 mm	195 ± 5 mm	30 ± 5 mm
349 ± 5 mm	349 ± 5 mm	33 ± 5 mm

Type Designation System

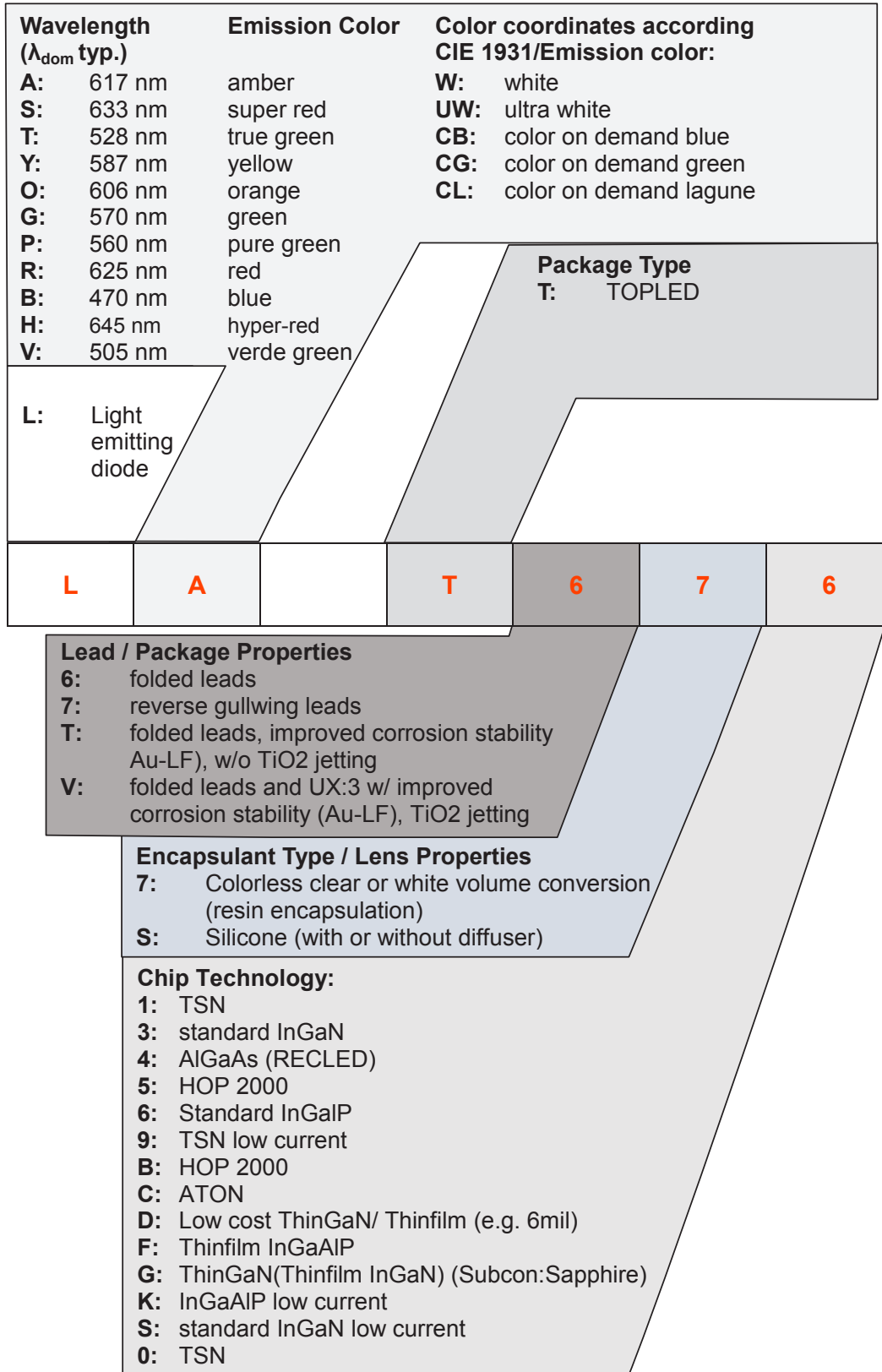

Not for new design

Notes

The evaluation of eye safety occurs according to the standard IEC 62471:2006 (photo biological safety of lamps and lamp systems). Within the risk grouping system of this IEC standard, the LED specified in this data sheet fall into the class **exempt group (exposure time 10000 s)**. Under real circumstances (for exposure time, conditions of the eye pupils, observation distance), it is assumed that no endangerment to the eye exists from these devices. As a matter of principle, however, it should be mentioned that intense light sources have a high secondary exposure potential due to their blinding effect. When looking at bright light sources (e.g. headlights), temporary reduction in visual acuity and afterimages can occur, leading to irritation, annoyance, visual impairment, and even accidents, depending on the situation.

Subcomponents of this LED contain, in addition to other substances, metal filled materials including silver. Metal filled materials can be affected by environments that contain traces of aggressive substances. Therefore, we recommend that customers minimize LED exposure to aggressive substances during storage, production, and use. LEDs that showed visible discoloration when tested using the described tests above did show no performance deviations within failure limits during the stated test duration. Respective failure limits are described in the IEC60810.

For further application related informations please visit www.osram-os.com/appnotes

Disclaimer

Disclaimer

Language english will prevail in case of any discrepancies or deviations between the two language wordings.

Attention please!

The information describes the type of component and shall not be considered as assured characteristics. Terms of delivery and rights to change design reserved. Due to technical requirements components may contain dangerous substances.

For information on the types in question please contact our Sales Organization.

If printed or downloaded, please find the latest version on the OSRAM OS website.

Packing

Please use the recycling operators known to you. We can also help you – get in touch with your nearest sales office.

By agreement we will take packing material back, if it is sorted. You must bear the costs of transport. For packing material that is returned to us unsorted or which we are not obliged to accept, we shall have to invoice you for any costs incurred.

Product safety devices/applications or medical devices/applications

OSRAM OS components are not developed, constructed or tested for the application as safety relevant component or for the application in medical devices.

In case Buyer – or Customer supplied by Buyer– considers using OSRAM OS components in product safety devices/applications or medical devices/applications, Buyer and/or Customer has to inform the local sales partner of OSRAM OS immediately and OSRAM OS and Buyer and /or Customer will analyze and coordinate the customer-specific request between OSRAM OS and Buyer and/or Customer.

Glossary

- 1) **Brightness:** Brightness values are measured during a current pulse of typically 25 ms, with an internal reproducibility of $\pm 8\%$ and an expanded uncertainty of $\pm 11\%$ (acc. to GUM with a coverage factor of $k = 3$).
- 2) **Reverse Operation:** Reverse Operation of 10 hours is permissible in total. Continuous reverse operation is not allowed.
- 3) **Wavelength:** The wavelength is measured at a current pulse of typically 25 ms, with an internal reproducibility of ± 0.5 nm and an expanded uncertainty of ± 1 nm (acc. to GUM with a coverage factor of $k = 3$).
- 4) **Forward Voltage:** The forward voltage is measured during a current pulse of typically 8 ms, with an internal reproducibility of ± 0.05 V and an expanded uncertainty of ± 0.1 V (acc. to GUM with a coverage factor of $k = 3$).
- 5) **Thermal Resistance:** $R_{th\ max}$ is based on statistic values (6σ).
- 6) **Thermal Resistance:** R_{thJA} results from mounting on PC board FR 4 (pad size 16 mm² per pad)
- 7) **Typical Values:** Due to the special conditions of the manufacturing processes of LED, the typical data or calculated correlations of technical parameters can only reflect statistical figures. These do not necessarily correspond to the actual parameters of each single product, which could differ from the typical data and calculated correlations or the typical characteristic line. If requested, e.g. because of technical improvements, these typ. data will be changed without any further notice.
- 8) **Characteristic curve:** In the range where the line of the graph is broken, you must expect higher differences between single LEDs within one packing unit.
- 9) **Tolerance of Measure:** Unless otherwise noted in drawing, tolerances are specified with ± 0.1 and dimensions are specified in mm.
- 10) **Tape and Reel:** All dimensions and tolerances are specified acc. IEC 60286-3 and specified in mm.

Published by OSRAM Opto Semiconductors GmbH
Leibnizstraße 4, D-93055 Regensburg
www.osram-os.com © All Rights Reserved.

EU RoHS and China RoHS compliant product



此产品符合欧盟 RoHS 指令的要求；
按照中国的相关法规和标准，不含有毒有害物质或元素。