

*RoHS COMPLIANT

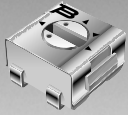

BOURNS®

Features

- Surface Mount / Single Turn / Cermet Industrial / Sealed
- Compatible with surface mount manufacturing processes
- Compatible with popular vacuum pick-and-place equipment
- J-hook, gull-wing and pinned configurations
- Side adjust available
- Meets EIA/EIAJ/IPC/VECI SMD standard trimmer designs
- RoHS compliant* - see [processing information](#) on lead free surface mount trimmers
- For trimmer applications/processing guidelines, [click here](#)

3314 - 4 mm Square Timpot® Trimming Potentiometer

Electrical Characteristics

Standard Resistance Range 10 ohms to 2 megohms (see standard resistance table)
 Resistance Tolerance ±20 % std. (tighter tolerance available)
 End Resistance 1 % or 2 ohms max. (whichever is greater)
 Contact Resistance Variation 3 % or 3 ohms
 Resolution Infinite
 Insulation Resistance 500 vdc. 100 megohms min.
 Dielectric Strength
 Sea Level..... 500 vac (1 minute)
 Adjustment Angle 210 ° nom.

Environmental Characteristics

Power Rating (300 volts max. for Style G, J & H; 50 volts max. for Style R)
 70 °C 0.25 watt
 125 °C 0 watt
 Temperature Range ... -55 °C to +125 °C
 Temperature Coefficient ... ±100 ppm/°C
 Humidity 90-98 % RH, 10 cycles, 240 hours
 TRS ±2 %; IR 10 megohms
 Vibration 20 G TRS ±1 %; VRS ±1 %
 Shock 100 G TRS ±1 %; VRS ±1 %
 Load Life
 ...(@ 70 °C Rated Power 1000 Hours)
 TRS ±3 %
 Rotational Life 100 cycles
 TRS ±3 %
 Thermal Shock 5 cycles
 TRS ±2 %; VRS ±1 %

Physical Characteristics

Mechanical Angle 240 ° nom.
 Torque 180 g-cm max.
 Stop Strength 300 g-cm min.
 Pushover Strength (S & Z Style)
 1.6 kilograms (3.5 lbs.) min.
 Weight Approximately 0.01 oz.
 Marking Manufacturer's code, resistance code and date code
 Wiper 50 % (Actual TR) ±10 %
 Flammability U.L. 94V-0
 Standard Packaging
 J, G and R...500 pcs./7 " reel (MSL-1)
 S and Z.....200 pcs./7 " reel (MSL-1)
 H.....100 pcs./tube
 Adjustment Tool..... H-90

Product Dimensions

3314J-1

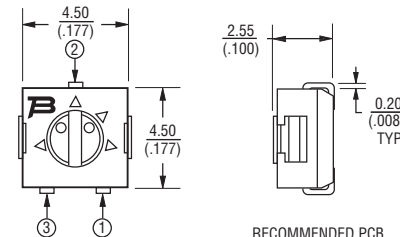

RECOMMENDED PCB LAYOUT

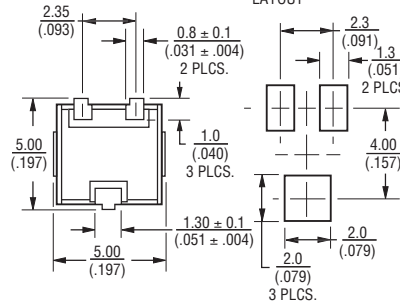

3314G-1

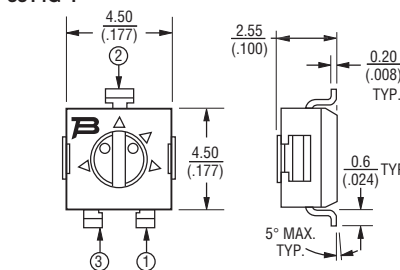

RECOMMENDED PCB LAYOUT

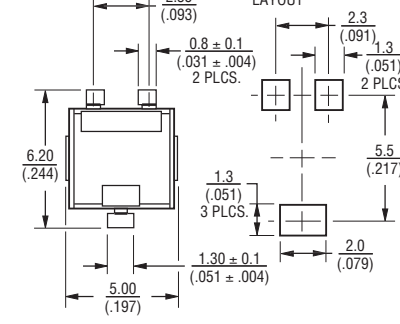

DIMENSIONS: MM (INCHES)

TOLERANCES: ± 0.25 (.010) EXCEPT WHERE NOTED

3314J-1, G-1, R-1, H-1 (Bourns Marking, Straight Slot)

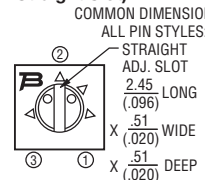

3314J-2, G-2, R-2, H-2 (Bourns Marking, Cross Slot)

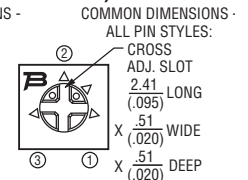

3314J-3, G-3, R-3, H-3 (Reverse Marking, Straight Slot)

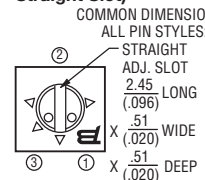

3314J-4, G-4, R-4, H-4 (Reverse Marking, Cross Slot)

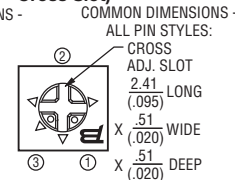

How To Order

Model 3314 J - 1 - 502 E

Style _____

Standard or Modified Product Indicator (Styles J, G, R, H & S)
 -1 = Single Slot
 -2 = Cross Slot
 -3 = Single Slot w/Reverse Marking
 -4 = Cross Slot w/Reverse Marking

Product Indicator (Style Z only)
 -GA4 = Single Slot
 -1 = Cross Slot
 -3 = Single Slot w/Reverse Marking
 -4 = Cross Slot w/Reverse Marking

Resistance Code _____

Embossed Tape Designator (MSL-1)**
 E = Styles J, G and R: 500 pcs./7 " reel
 Styles S and Z: 200 pcs./7 " reel
 G = Styles J and G: 3000 pcs./13 " reel
 Style R: 2500 pcs./13 " reel
 Styles S and Z: 1000 pcs./13 " reel

**Style H is available in tube packaging only.

Standard Resistance Table

Resistance (Ohms)	Resistance Code
10	100
20	200
50	500
100	101
200	201
500	501
1,000	102
2,000	202
5,000	502
10,000	103
20,000	203
50,000	503
100,000	104
200,000	204
250,000	254
500,000	504
1,000,000	105
2,000,000	205

Popular distribution values listed in boldface. Special resistances available.

*RoHS Directive 2002/95/EC Jan. 27, 2003 including annex and RoHS Recast 2011/65/EU June 8, 2011.

Specifications are subject to change without notice.

The device characteristics and parameters in this data sheet can and do vary in different applications and actual device performance may vary over time.

Users should verify actual device performance in their specific applications.

3314 - 4 mm Square Trimpot® Trimming Potentiometer

BOURNS®

Product Dimensions

3314R-1

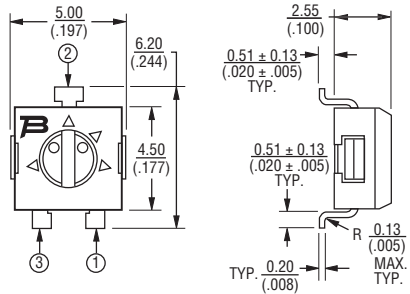

RECOMMENDED PCB LAYOUT

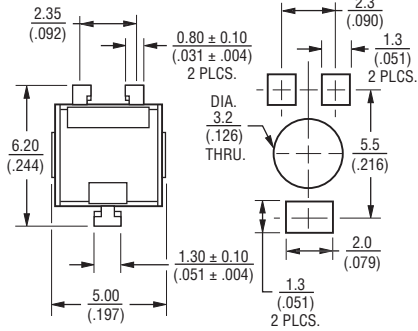

3314H-1

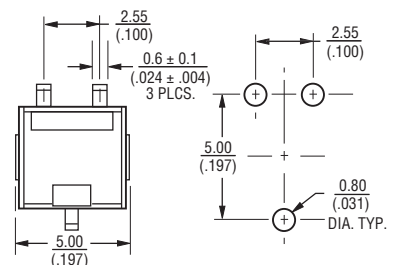
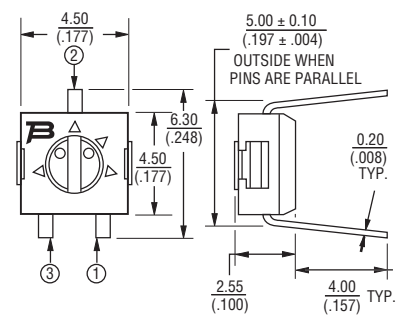

Packaging Specifications - J, G and R Styles

(J, G Styles)

TAPE

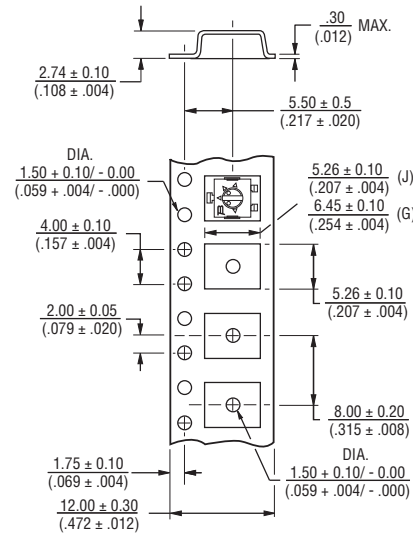

REEL

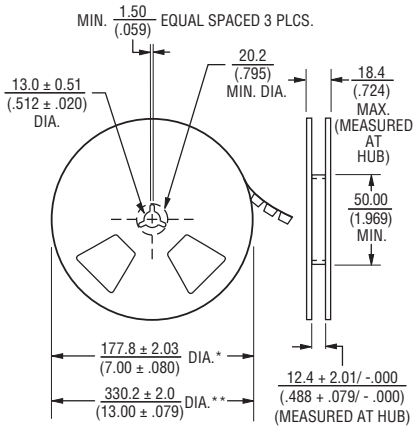

(R Style)

TAPE

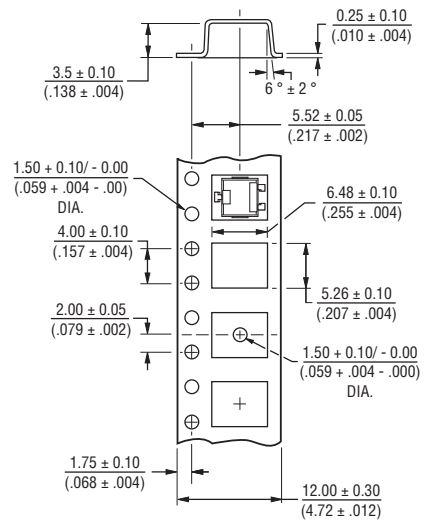

REEL

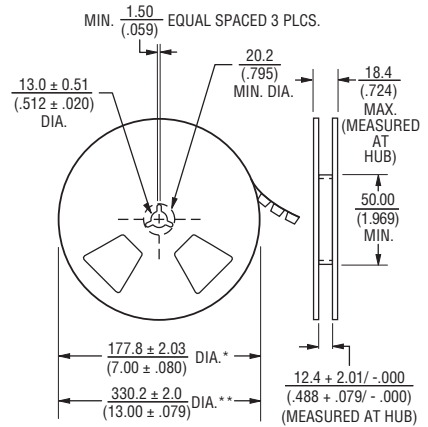

* Embossed Tape Designator 'E'
** Embossed Tape Designator 'G'
(See How To Order chart for further information.)

Meets EIA specification 481.

* Embossed Tape Designator 'E'
** Embossed Tape Designator 'G'
(See How To Order chart for further information.)

Meets EIA specification 481.

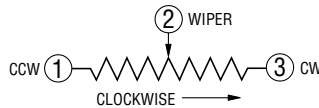

DIMENSIONS: $\frac{\text{MM}}{\text{(INCHES)}}$
TOLERANCES: $\pm \frac{0.25}{(.010)}$ EXCEPT WHERE NOTED

Specifications are subject to change without notice. The device characteristics and parameters in this data sheet can and do vary in different applications and actual device performance may vary over time. Users should verify actual device performance in their specific applications.

3314 - 4 mm Square Trimpot® Trimming Potentiometer

BOURNS®

Product Dimensions

3314S-1
(Bourns Marking, Straight Slot)

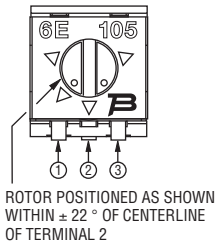

3314S-2
(Bourns Marking, Cross Slot)

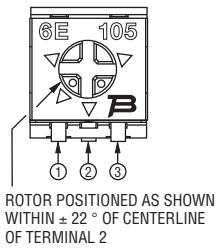

3314S-3
(Reverse Marking, Straight Slot)

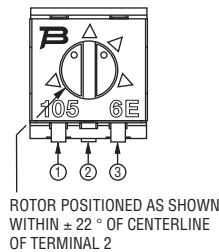

3314S-4
(Reverse Marking, Cross Slot)

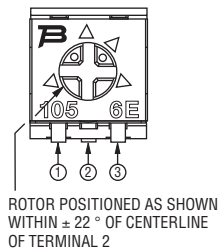

3314S
Common Dimensions

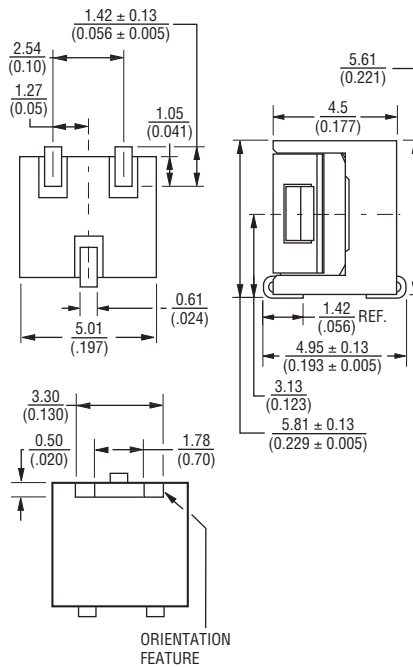

RECOMMENDED PCB LAYOUT

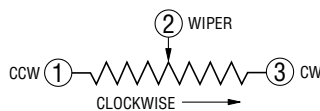
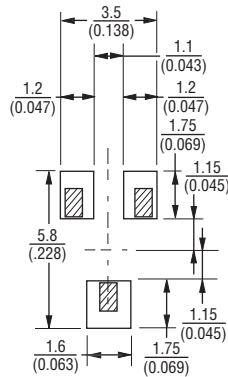

Packaging Specifications

(S Style)

TAPE

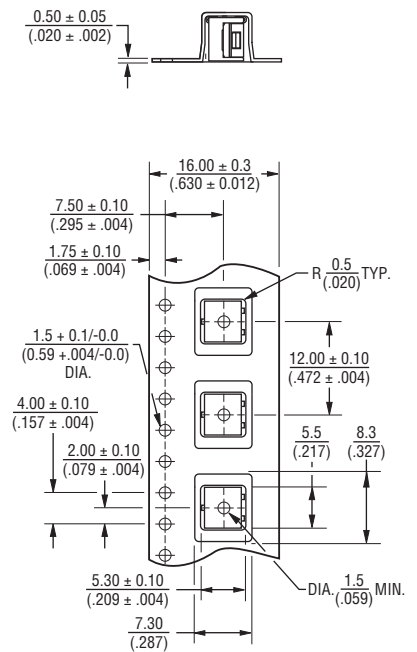

REEL

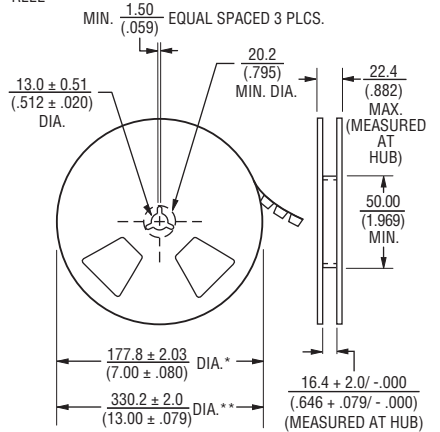

* Embossed Tape Designator "E"
** Embossed Tape Designator "G"
(See How To Order chart for further information.)

Meets EIA specification 481.

DIMENSIONS: $\frac{\text{MM}}{\text{(INCHES)}}$

TOLERANCES: $\pm \frac{0.30}{(0.012)}$ EXCEPT WHERE NOTED

Specifications are subject to change without notice. The device characteristics and parameters in this data sheet can and do vary in different applications and actual device performance may vary over time. Users should verify actual device performance in their specific applications.

3314 - 4 mm Square Trimpot® Trimming Potentiometer

BOURNS®

Product Dimensions

3314Z-1-(RC) E
(Cross Slot)

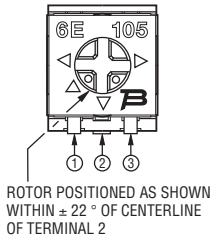

3314Z-GA4-(RC) E
(Straight Slot)

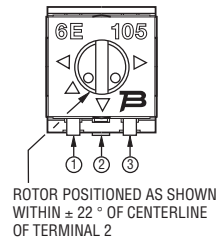

3314Z-3
(Reverse Marking, Straight Slot)

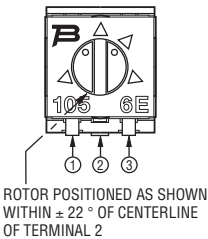

3314Z-4-(RC) E
(Reverse Marking, Cross Slot)

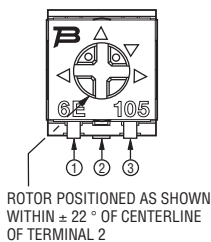

3314Z
Common Dimensions

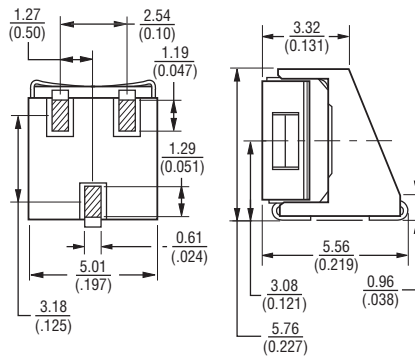

RECOMMENDED PCB LAYOUT

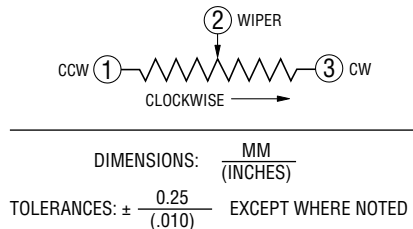
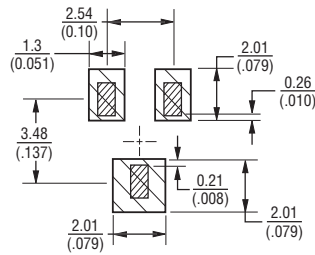

Packaging Specifications

(Z Style)

TAPE

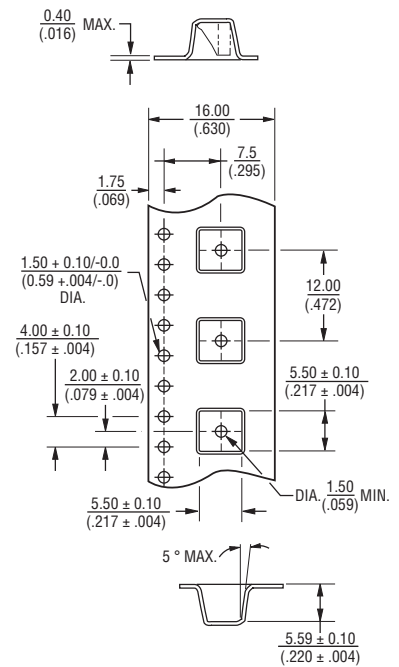

REEL

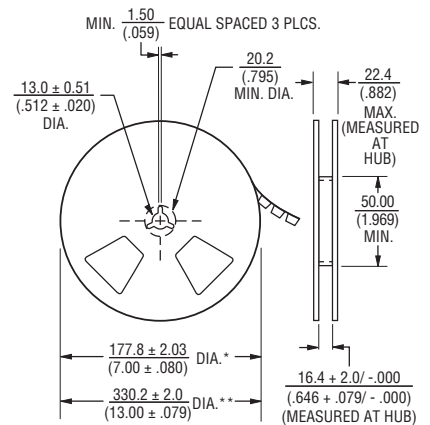

* Embossed Tape Designator "E"
** Embossed Tape Designator "G"
(See How To Order chart for further information.)

Meets EIA specification 481.