

FT2/FU2 Relay

2 pole telecom/signal relay
Through Hole Type (THT)
Surface Mount Typ (SMT)
Non-polarized, non-latching 1 coil

ROHS compliant (Directive 2002/95/EC) as per product date code 0427.

Features

- Telecom/signal relay (dry circuit, test access, ringing)
- Slim line 15 x 7.5 mm, 0.59 x 0.295 inch
- Switching current 2 A
- 2 changeover contacts (2 form C / DPDT)
- Bifurcated contacts
- High sensitive 24 V and 48 V coil versions
- Meets Telcordia GR 1089, FCC Part 68 and ITU-T K20 ≥ 2500 V between coil and contacts

Typical applications

- Communications equipment
Linecard application – analog, ISDN, xDSL, PABX
Voice over IP
- Office and business equipment
- Measurement and control equipment
- Consumer electronics
Set top boxes, HiFi
- Medical equipment

Options

- High Dielectric Version (HDV) with > 6000 V surge voltage between coil and contacts
- Suitable for 125 °C ambient temperature

Insulation category

Supplementary insulation according IEC / EN 60950 and UL 60950

Working voltage	≤ 300 Vrms
Mains supply voltage	≤ 250 Vrms
Repetitive peak voltage	1500 V
Pollution degree	Internal: 1 External: 2
Flammability classification	V-0
Maximum operating temperature	85 °C

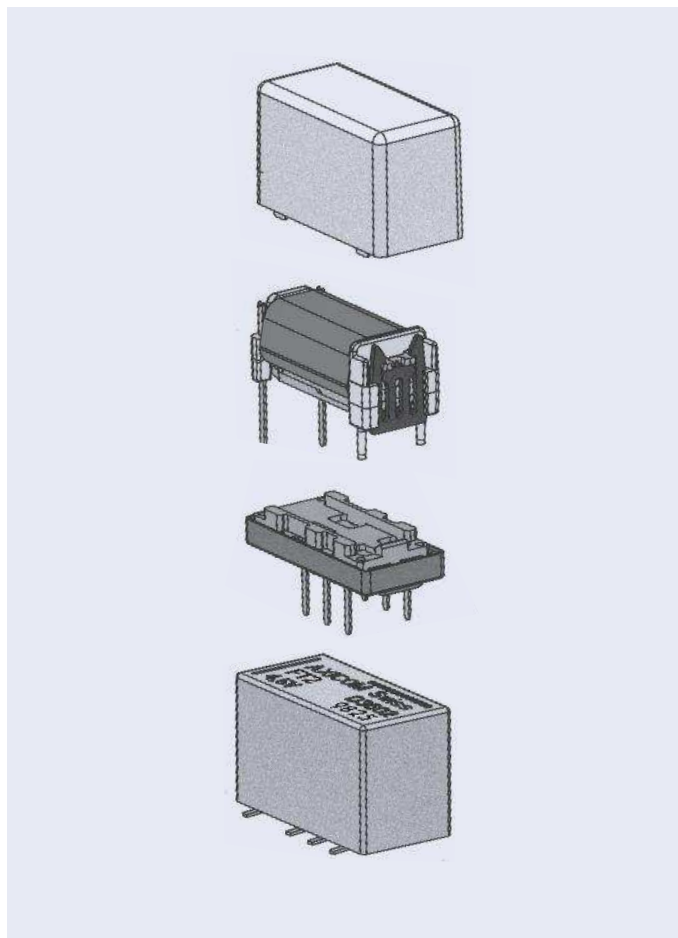

FT2/FU2 Relay

Dimensions

Dimensions in mm

	FT2 THT		FU2 SMT long terminals		FU2 SMT short terminals	
	mm	inch	mm	inch	mm	inch
L	15.0 ± 0.05	0.590 ± 0.002	15.0 ± 0.05	0.590 ± 0.002	15.0 ± 0.05	0.590 ± 0.002
W	7.5 ± 0.05	0.295 ± 0.002	7.5 ± 0.05	0.295 ± 0.002	7.6 ± 0.05	0.295 ± 0.002
H	9.6 ± 0.03	0.377 ± 0.001	10.0 ± 0.15	0.393 ± 0.006	10.0 ± 0.15	0.393 ± 0.006
T	3.30 ± 0.30	0.129 ± 0.011	N/A	N/A	N/A	N/A
T1	N/A	N/A	9.2 ± 0.2	0.362 ± 0.008	7.5 ± 0.2	0.295 ± 0.008
T2	5.08	0.200	5.08	0.200	5.08	0.200
Tw	0.50	0.020	0.50	0.020	0.50	0.020
S	0.35 ± 0.03	0.013 ± 0.001	N/A	N/A	N/A	N/A

FT2: THT Version

FU2: SMT Version

Long terminals (W)

Short terminals (N)

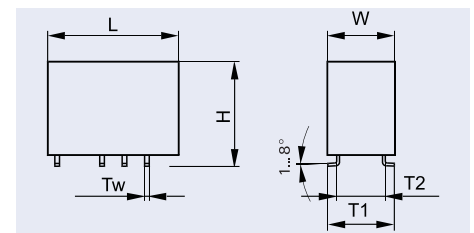
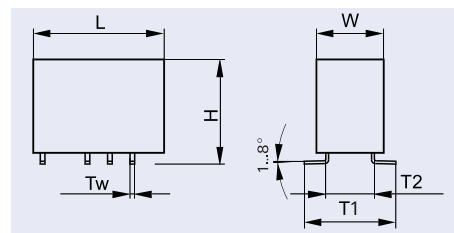
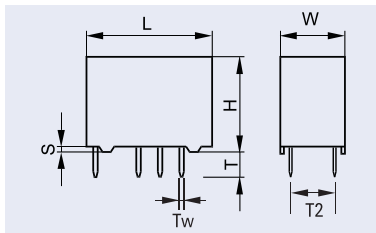

Coplanarity ≤ 0.1mm

Coplanarity ≤ 0.1mm

Mounting hole layout

View onto the component side of the PCB (top view)

Solder pad layout

View onto the component side of the PCB (top view)

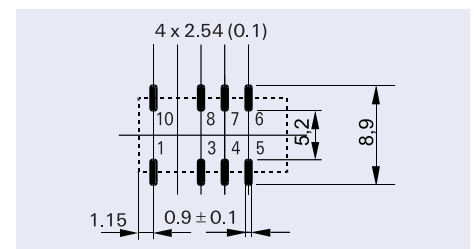
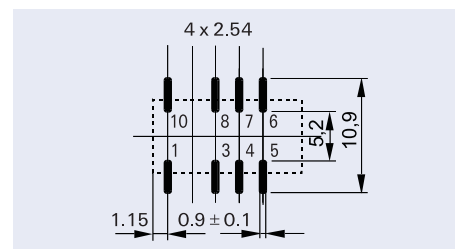
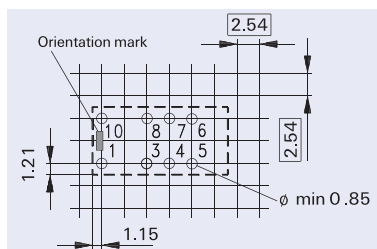

Terminal assignment

Relay – top view

Non-latching 1 coil
not energized condition

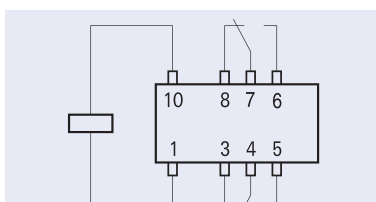

FT2/FU2 Relay

Coil Operating Range

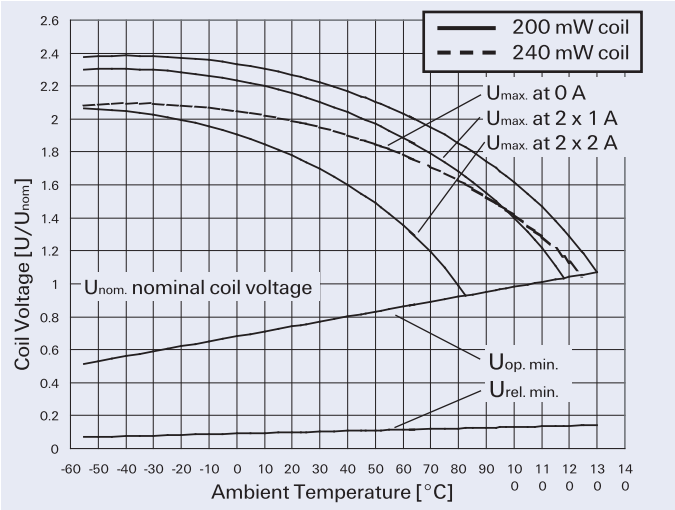

U_{nom} = Nominal coil voltage

U_{max.} = Upper limit of the operative range of the coil voltage (limiting voltage) when coils are continuously energized

U_{op. min.} = Lower limit of the operative range of the coil voltage (reliable operate voltage)

U_{rel. min.} = Lower limit of the operative range of the coil voltage (reliable release voltage)

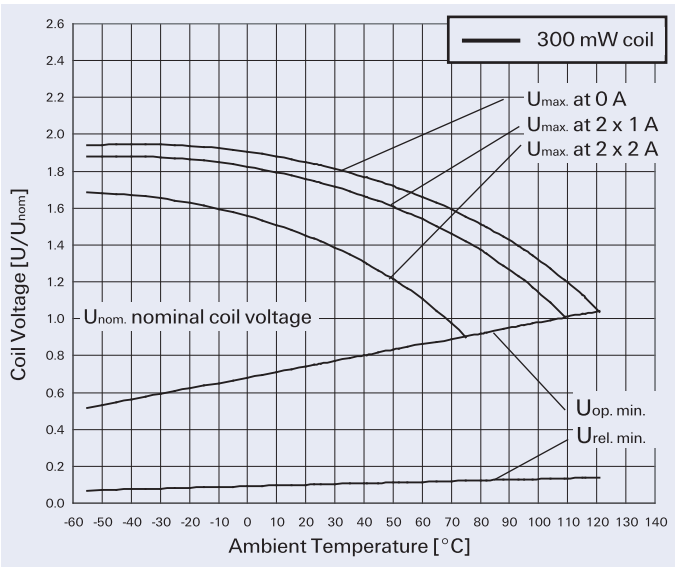

FT2/FU2 Relay

Coil Data (values at 23 °C)

Ordering Information

Nominal voltage Unom	Operate/set voltage range		Release/ reset voltage Minimum	Coil power	Coil Resistance	Relay code	Tyco part number
	Minimum voltage Umin	Maximum voltage Umax					
Vdc	Vdc	Vdc	Vdc	mW	Ω / ± 10 %		

Sensitive Version

THT non-latching

3	2.25	6.8	0.30	200	45	D3421	1462035-9
4	3.00	9.0	0.40	200	80	D3429	1-1462035-9
4.5	3.38	10.1	0.45	200	101	D3422	1-1462035-0
5	3.75	11.2	0.50	200	125	D3423	1-1462035-1
6	4.50	13.5	0.60	200	180	D3424	1-1462035-2
9	6.75	20.3	0.90	200	405	D3425	1-1462035-3
12	9.00	27.0	1.20	200	720	D3426	1-1462035-4
24	18.00	47.5	2.40	240	2400	D3427	1-1462035-7
48	36.00	95.0	4.80	240	9600	D3428	1-1462035-8

SMT Long Terminals, non-latching

3	2.25	6.8	0.30	200	45	D3521W	1-1462036-8
4	3.00	9.0	0.40	200	80	D3529W	3-1462036-1
4.5	3.38	10.1	0.45	200	101	D3522W	2-1462036-0
5	3.75	11.2	0.50	200	125	D3523W	2-1462036-2
6	4.50	13.5	0.60	200	180	D3524W	2-1462036-4
9	6.75	20.3	0.90	200	405	D3525W	2-1462036-6
12	9.00	27.0	1.20	200	720	D3526W	2-1462036-8
24	18.00	47.5	2.40	240	2400	D3527W	9-1462036-1
48	36.00	95.0	4.80	240	9600	D3528W	9-1462036-5

SMT Short Terminals, non-latching

3	2.25	6.8	0.30	200	45	D3521N	1-1462036-7
4	3.00	9.0	0.40	200	80	D3529N	3-1462036-0
4.5	3.38	10.1	0.45	200	101	D3522N	1-1462036-9
5	3.75	11.2	0.50	200	125	D3523N	2-1462036-1
6	4.50	13.5	0.60	200	180	D3524N	2-1462036-3
9	6.75	20.3	0.90	200	405	D3525N	2-1462036-5
12	9.00	27.0	1.20	200	720	D3526N	2-1462036-7
24	18.00	47.5	2.40	240	2400	D3527N	2-1462036-9
48	36.00	95.0	4.80	240	9600	D3528N	9-1462036-3

Further coil versions are available on request.

FT2/FU2 Relay

Coil Data (values at 23 °C)

Ordering Information

Nominal voltage Unom	Operate/set voltage range		Release/ reset voltage Minimum	Coil power	Coil Resistance	Relay code	Tyco part number
	Minimum voltage Umin	Maximum voltage Umax					
Vdc	Vdc	Vdc	Vdc	mW	Ω / ± 10 %		

High Dielectric Version

THT non-latching, Sensitive Version

3	2.25	6.80	0.30	200	45	D3491L	2-1462035-7
5	3.75	11.20	0.50	200	125	D3493L	2-1462035-8
12	9.00	27.00	1.20	200	720	D3496	2-1462035-4
24	18.00	47.50	2.40	240	2400	D3497	2-1462035-5

SMT Short Terminals, non-latching, Sensitive Version

3	2.25	6.80	0.30	200	45	D3591N	7-1462035-7
5	3.75	11.20	0.50	200	125	D3593N	7-1462035-8
12	9.00	27.00	1.20	200	720	D3596N	7-1462035-9

SMT Long Terminals, non-latching, Sensitive Version

3	2.25	6.80	0.30	200	45	D3591W	9-1462036-7
5	3.75	11.20	0.50	200	125	D3593W	9-1462036-8
12	9.00	27.00	1.20	200	720	D3596W	9-1462036-9

High Dielectric Version - IEC 60950 (Australia)

SMT Short Terminals, non-latching, Standard Version

3	2.25	5.50	0.30	300	30	D3571N	7-1462035-5
5	3.75	9.20	0.50	300	83	D3573N	7-1462035-6
12	9.00	22.10	1.20	300	480	D3576N	7-1462035-3

SMT Long Terminals, non-latching, Standard Version

3	2.25	5.50	0.30	300	30	D3571W	7-1462035-1
5	3.75	9.20	0.50	300	83	D3573W	7-1462035-2
12	9.00	22.10	1.20	300	480	D3576W	7-1462035-4

Further coil versions are available on request.

FT2/FU2 Relay

Coil Data (values at 23 °C)

Ordering Information

Nominal voltage Unom	Operate/set voltage range		Release/ reset voltage Minimum	Coil power	Coil Resistance	Relay code	Tyco part number
	Minimum voltage Umin	Maximum voltage Umax					
Vdc	Vdc	Vdc	Vdc	mW	$\Omega / \pm 10\%$		

Standard Version

THT non-latching

3	2.25	5.5	0.30	300	30	D3401	1462035-1
4.5	3.38	8.3	0.45	300	68	D3402	1462035-2
5	3.75	9.2	0.50	300	83	D3403	1462035-3
6	4.50	11.0	0.60	300	120	D3404	1462035-4
9	6.75	16.6	0.90	300	270	D3405	1462035-5
12	9.00	22.1	1.20	300	480	D3406	1462035-6
24	18.00	44.2	2.40	300	1920	D3407	1462035-7
48	36.00	88.3	4.80	300	7680	D3408	1462035-8

SMT Long Terminals non-latching

3	2.25	5.5	0.30	300	30	D3401W	1462036-2
4.5	3.38	8.3	0.45	300	68	D3402W	1462036-4
5	3.75	9.2	0.50	300	83	D3403W	1462036-6
6	4.50	11.0	0.60	300	120	D3404W	1462036-8
9	6.75	16.6	0.90	300	270	D3405W	1-1462036-0
12	9.00	22.1	1.20	300	480	D3406W	1-1462036-2
24	18.00	44.2	2.40	300	1920	D3407W	1-1462036-4
48	36.00	88.3	4.80	300	7680	D3408W	1-1462036-6

SMT Short Terminals non-latching

3	2.25	5.5	0.30	300	30	D3401N	1462036-1
4.5	3.38	8.3	0.45	300	68	D3402N	1462036-3
5	3.75	9.2	0.50	300	83	D3403N	1462036-5
6	4.50	11.0	0.60	300	120	D3404N	1462036-7
9	6.75	16.6	0.90	300	270	D3405N	1462036-9
12	9.00	22.1	1.20	300	480	D3406N	1-1462036-1
24	18.00	44.2	2.40	300	1920	D3407N	1-1462036-3
48	36.00	88.3	4.80	300	7680	D3408N	1-1462036-5

Further coil versions are available on request.

FT2/FU2 Relay

Contact Data

	Standard Version / Sensitive Version / High Dielectric Version
Number of contacts and type	2 changeover contacts
Contact assembly	Bifurcated contacts
Contact material	Palladium-ruthenium, gold covered
Limiting continuous current at max. ambient temperature	2 A
Maximum switching current	2 A
Maximum switching voltage	220 Vdc 250 Vac
Maximum switching capacity	60 W, 62.5 VA
Thermoelectric potential	< 10 μ V
Minimum switching voltage	100 μ V
Initial contact resistance / measuring condition: 10 mA / 20 mV	< 50 m Ω
Electrical endurance at contact application 0 (≤ 30 mV / ≤ 10 mA) at cable load open end Resistive load at 125 Vdc / 0.24 A - 30 W at 250 Vac / 0.25 A - 62.5 VA at 24 V / 1.25 A - 30 W	min. 2.5×10^6 operations min. 2.0×10^6 operations min. 1.0×10^5 operations min. 1.0×10^5 operations min. 1.0×10^5 operations
Mechanical endurance	typ. 10^8 operations
UL contact ratings	220 Vdc / 0.24 A - 60 W 125 Vdc / 0.24 A - 30 W 250 Vac / 0.25 A - 62.5 VA 125 Vac / 0.5 A - 62.5 VA 30 Vdc / 2 A - 60 W

Max. DC Load Breaking Capacity

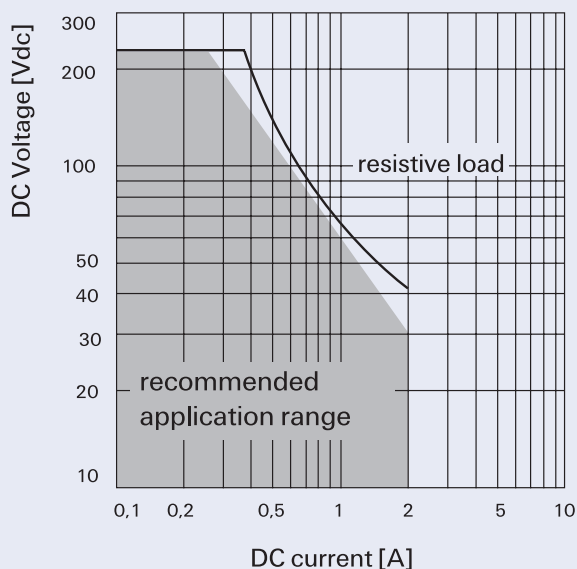

FT2/FU2 Relay

Insulation

	Standard Version	High Dielectric Version
Insulation resistance at 500 Vdc	> 10 ⁹ Ω	> 10 ⁹ Ω
Dielectric test voltage (1 min)		
between coil and contacts	1500 Vrms	4000 Vrms
between adjacent contact sets	1500 Vrms	1800 Vrms
between open contacts	1000 Vrms	1500 Vrms
Surge voltage resistance		
according IEC (10 / 700 μs)		
between coil and contacts	2500 V	6000 V
between adjacent contact sets	1500 V	2500 V
between open contacts	1500 V	2500 V
according to FCC 68 (10 / 160 μs)		
between coil and contacts	2500 V	6000 V
between adjacent contact sets	1500 V	2500 V
between open contacts	1500 V	2500 V

High Frequency Data

Capacitance	
between coil and contacts	max. 4 pF
between adjacent contact sets	max. 1 pF
between open contacts	max. 1 pF
RF Characteristics	
Isolation at 100 MHz / 900 MHz	- 30.6 dB / - 13.7 dB
Insertion loss at 100 MHz / 900 MHz	- 0.02 dB / - 0.50 dB
V.S.W.R. at 100 MHz / 900 MHz	1.02 / 1.27

General Data

Operate time at U _{nom} typ. / max.	3 ms / 5 ms
Release time without diode in parallel (non-latching), typ. / max.	2 ms / 5 ms
Release time with diode in parallel (non-latching), typ. / max.	4 ms / 5 ms
Bounce time at closing contact, typ. / max.	1 ms / 5 ms
Maximum switching rate without load	50 operations/s
Ambient temperature	-55 °C ... +85 °C
Thermal resistance	< 125 K/W
Maximum permissible coil temperature	150 °C
Vibration resistance (function)	10 G 10 to 500 Hz
Shock resistance, half sinus, 11 ms	15 G (function) 500 G (damage)
Degree of protection / Environmental protection	immersion cleanable, IP 67 / RT III / RT V
Needle flame test	application time 20 s, no burning or glowing
Mounting position	any
Processing information	Ultrasonic cleaning is not recommended
Weight (mass)	max. 3 g
Terminal surface	SnCu 0.7
Moisture sensitive level (JDEC J-STD-020B) - SMD types	MSL 3
Resistance to soldering heat	265 °C / 10 s