

Miniature Aluminum Electrolytic Capacitors

NRSA Series

RADIAL LEADS, POLARIZED, STANDARD CASE SIZING

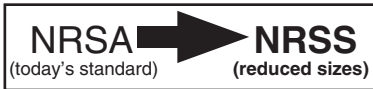

RoHS Compliant
includes all homogeneous materials

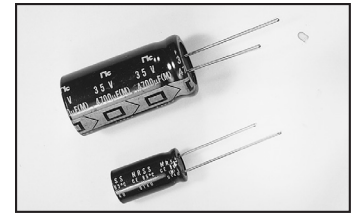

CHARACTERISTICS

*See Part Number System for Details

Rated Voltage Range		6.3 ~ 100Vdc							
Capacitance Range		0.47 ~ 10,000 μ F							
Operating Temperature Range		-40 ~ +85°C							
Capacitance Tolerance		\pm 20%(M)							
Max. Leakage Current @ +20°C	After 1 min.	0.03CV or 4 μ A, whichever is greater							
	After 2 min.	0.01CV or 3 μ A, whichever is greater							
Max. Tan δ @ 120Hz/+20°C	W.V. (Vdc)	6.3	10	16	25	35	50	63	100
	S.V. (Vdc)	8	13	20	32	44	63	79	125
	C \leq 1,000 μ F	0.24	0.20	0.16	0.14	0.12	0.10	0.10	0.10
	C = 2,200 μ F	0.24	0.21	0.18	0.16	0.14	0.12	0.11	-
	C = 3,300 μ F	0.26	0.23	0.20	0.18	0.16	0.14	0.13	-
	C = 4,700 μ F	0.28	0.25	0.22	0.20	0.18	0.20	-	-
	C = 6,800 μ F	0.32	0.29	0.26	0.24	-	-	-	-
Low Temperature Stability Impedance Ratio @ 120Hz	Z-25°C/Z+20°C	4	3	2	2	2	2	2	2
	Z-40°C/Z+20°C	10	8	6	4	3	3	3	3
Load Life Test at Rated W.V. +85°C 2,000 Hours	Capacitance Change	Within \pm 20% of initial measured value							
	Tan δ	Less than 200% of specified maximum value							
	Leakage Current	Less than specified maximum value							
Shelf Life Test +85°C 1,000 Hours No Load	Capacitance Change	Within \pm 20% of initial measured value							
	Tan δ	Less than 200% of specified maximum value							
	Leakage Current	Less than specified maximum value							

Note: Capacitors shall conform to JIS-C-5141, unless otherwise specified here.

STANDARD PRODUCTS AND CASE SIZE TABLE: D ϕ x L (mm)

Cap. (μ F)	Code	Working Voltage (Vdc)							
		6.3	10	16	25	35	50	63	100
0.47	R47	-	-	-	-	-	5x11	-	5x11
1.0	1R0	-	-	-	-	-	5.11	-	5x11
2.2	2R2	-	-	-	-	-	5x11	-	5x11
3.3	3R3	-	-	-	-	-	5x11	-	5x11
4.7	4R7	-	-	-	-	-	5x11	5x11	5x11
10	100	-	-	5x11	-	5x11	5x11	5x11	6.3x11
22	220	-	-	5x11	5x11	5x11	5x11	6.3x11	8x11.5
33	330	-	-	5x11	5x11	5x11	6.3x11	6.3x11	10x12.5
47	470	-	5x11	5x11	5x11	6.3x11	6.3x11	8x11.5	10x16
100	101	-	5x11	6.3x11	6.3x11	8x11.5	8x11.5	10x12.5	12.5x20
150	151	-	5x11	6.3x11	8x11.5	8x11.5	10x12.5	10x16	12.5x20
220	221	-	6.3x11	8x11.5	8x11.5	10x12.5	10x16	10x20	16x25
330	331	6.3x11	8x11.5	8x11.5	10x12.5	10x16	10x20	12.5x20	16x25
470	471	8x11.5	8x11.5	10x12.5	10x16	10x20	12.5x20	12.5x25	16x31.5
680	681	10x12.5	-	-	-	-	-	-	-
1,000	102	10x12.5	10x16	10x20	12.5x20	12.5x25	16x25	16x31.5	-
1,500	152	10x20	12.5x20	12.5x25	12.5x25	16x25	-	18x36	-
2,200	222	12.5x20	12.5x20	12.5x25	16x25	16x31.5	18x35.5	18x35.5	-
3,300	332	12.5x20	12.5x25	16x25	16x31.5	18x35.5	22x36	22x42	-
4,700	472	16x25	16x25	16x31.5	18x35.5	22x36	22x42	-	-
6,800	682	16x25	16x31	18x36	22x36	-	-	-	-
10,000	103	16x31	18x36	22x36	22x36	-	-	-	-

LEAD SPACING AND DIAMETER (mm)

Case Dia. (D ϕ)	5	6.3	8	10	12.5	16	18	22
Lead Dia (d ϕ)	0.5	0.5	0.6	0.6	0.6	0.8	0.8	0.8
Lead Spacing (F)	2.0	2.5	3.5	5.0	5.0	7.5	7.5	10
Dim. α	0.5	0.5	0.5	0.5	0.5	0.5	0.5	1.0

$$\beta = L < 20\text{mm} = 1.5\text{mm}, L \geq 20\text{mm} = 2.0\text{mm}$$

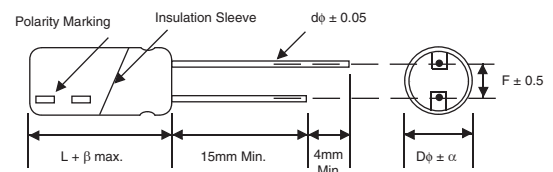

Drawing is representative of parts as supplied in bulk or straight lead format, please see taping specification for details on taped format packaging.



STANDARD PRODUCT, SPECIFICATIONS AND CASE SIZES D ϕ x L (mm)

Part Number	Cap. (μ F)	W.V. (Vdc)	Dissipation Factor +20°C/120Hz	Ripple Current Rating (mA) +85°C/120Hz	Max. ESR (Ω) +20°C/120Hz	Load Life Hours @ +85°C
NRSA331M6.3V6.3x11F	330	6.3	0.24	240	1.11	2,000
NRSA471M6.3V8x11.5F	470		0.24	330	0.777	2,000
NRSA681M6.3V10x12.5F	680		0.24	460	0.526	2,000
NRSA102M6.3V10x12.5F	1,000		0.24	570	0.365	2,000
NRSA152M6.3V10x20F	1,500		0.24	790	0.243	2,000
NRSA222M6.3V12.5x20F	2,200		0.24	940	0.181	2,000
NRSA332M6.3V12.5x20F	3,300		0.26	1100	0.131	2,000
NRSA472M6.3V16x25F	4,700		0.28	1300	0.0988	2,000
NRSA682M6.3V16x25F	6,800		0.32	1600	0.0781	2,000
NRSA103M6.3V16x31F	10,000		0.40	1800	0.0663	2,000
NRSA470M10V5x11F	47	10	0.20	70	7.05	2,000
NRSA101M10V5x11F	100		0.20	130	3.16	2,000
NRSA151M10V5x11F	150		0.20	170	1.68	2,000
NRSA221M10V6.3x11F	220		0.20	210	1.44	2,000
NRSA331M10V8x11.5F	330		0.20	290	0.956	2,000
NRSA471M10V8x11.5F	470		0.20	350	0.671	2,000
NRSA102M10V10x16F	1,000		0.20	660	0.316	2,000
NRSA152M10V12.5x20F	1,500		0.20	870	0.210	2,000
NRSA222M10V12.5x20F	2,200		0.21	1000	0.159	2,000
NRSA332M10V12.5x25F	3,300		0.23	1200	0.116	2,000
NRSA472M10V16x25F	4,700		0.25	1500	0.0883	2,000
NRSA682M10V16x31F	6,800		0.29	1700	0.0708	2,000
NRSA103M10V18x36F	10,000		0.37	1900	0.0614	2,000
NRSA100M16V5x11F	10		16	0.16	28	26.5
NRSA220M16V5x11F	22	0.16		50	7.53	2,000
NRSA330M16V5x11F	33	0.16		80	8.05	2,000
NRSA470M16V5x11F	47	0.16		95	5.65	2,000
NRSA101M16V6.3x11F	100	0.16		160	2.66	2,000
NRSA151M16V6.3x11F	150	0.16		210	1.42	2,000
NRSA221M16V8x11.5F	220	0.16		260	1.21	2,000
NRSA331M16V8x11.5F	330	0.16		330	0.805	2,000
NRSA471M16V10x12.5F	470	0.16		440	0.565	2,000
NRSA102M16V10x20F	1,000	0.16		760	0.266	2,000
NRSA152M16V12.5x25F	1,500	0.16		1050	0.177	2,000
NRSA222M16V12.5x25F	2,200	0.18		1200	0.136	2,000
NRSA332M16V16x25F	3,300	0.20		1400	0.101	2,000
NRSA472M16V16x31.5F	4,700	0.22		1700	0.0777	2,000
NRSA682M16V18x36F	6,800	0.26	2000	0.0653	2,000	
NRSA103M16V22x36F	10,000	0.35	2650	0.0564	2,000	
NRSA220M25V5x11F	22	25	0.14	70	10.6	2,000
NRSA330M25V5x11F	33		0.14	85	7.04	2,000
NRSA470M25V5x11F	47		0.14	100	4.94	2,000
NRSA101M25V6.3x11F	100		0.14	170	2.33	2,000
NRSA151M25V8x11.5F	150		0.14	220	1.24	2,000
NRSA221M25V8x11.5F	220		0.14	270	1.06	2,000
NRSA331M25V10x12.5F	330		0.14	400	0.704	2,000
NRSA471M25V10x16F	470		0.14	510	0.494	2,000
NRSA102M25V12.5x20F	1,000		0.14	900	0.233	2,000
NRSA152M25V12.5x25F	1,500		0.14	1100	0.155	2,000
NRSA222M25V16x25F	2,200		0.16	1300	0.121	2,000
NRSA332M25V16x31.5F	3,300		0.18	1600	0.0905	2,000
NRSA472M25V18x35.5F	4,700		0.20	1900	0.0706	2,000
NRSA682M25V22x36F	6,800		0.24	2550	0.059	2,000
NRSA103M25V22x36F	10,000	0.32	2750	0.0531	2,000	



STANDARD PRODUCT, SPECIFICATIONS AND CASE SIZES D ϕ x L (mm)

Part Number	Cap. (μ F)	W.V. (Vdc)	Dissipation Factor +20°C/120Hz	Ripple Current Rating (mA) +85°C/120Hz	Max. ESR (Ω) +20°C/120Hz	Load Life Hours @ +85°C
NRSA100M35V5x11F	10	35	0.12	50	19.9	2,000
NRSA220M35V5x11F	22		0.12	75	9.05	2,000
NRSA330M35V5x11F	33		0.12	95	6.04	2,000
NRSA470M35V6.3x11F	47		0.12	120	4.24	2,000
NRSA101M35V8x11.5F	100		0.12	210	1.99	2,000
NRSA151M35V8x11.5F	150		0.12	290	1.08	2,000
NRSA221M35V10x12.5F	220		0.12	370	0.905	2,000
NRSA331M35V10x16F	330		0.12	470	0.604	2,000
NRSA471M35V10x20F	470		0.12	600	0.424	2,000
NRSA102M35V12.5x25F	1,000		0.12	960	0.199	2,000
NRSA152M35V16x25F	1,500		0.12	1200	0.133	2,000
NRSA222M35V16x31.5F	2,200		0.14	1400	0.106	2,000
NRSA332M35V18x35.5F	3,300		0.16	1700	0.0805	2,000
NRSA472M35V22x36F	4,700		0.18	2400	0.0635	2,000
NRSAR47M50V5x11F	0.47	50	0.10	10	353	2,000
NRSA1R0M50V5.11F	1.0		0.10	12	166	2,000
NRSA2R2M50V5x11F	2.2		0.10	20	75.4	2,000
NRSA3R3M50V5x11F	3.3		0.10	26	50.3	2,000
NRSA4R7M50V5x11F	4.7		0.10	33	35.3	2,000
NRSA100M50V5x11F	10		0.10	55	16.6	2,000
NRSA220M50V5x11F	22		0.10	85	7.54	2,000
NRSA330M50V6.3x11F	33		0.10	110	5.03	2,000
NRSA470M50V6.3x11F	47		0.10	140	3.53	2,000
NRSA101M50V8x11.5F	100		0.10	230	1.66	2,000
NRSA151M50V10x12.5F	150		0.10	330	0.88	2,000
NRSA221M50V10x16F	220		0.10	420	0.754	2,000
NRSA331M50V10x20F	330		0.10	580	0.503	2,000
NRSA471M50V12.5x20F	470		0.10	730	0.353	2,000
NRSA102M50V16x25F	1,000		0.10	1100	0.166	2,000
NRSA152M50V16x31F	1,500		0.10	1500	0.111	2,000
NRSA222M50V18x35.5F	2,200		0.12	1700	0.0905	2,000
NRSA332M50V22x36F	3,300		0.14	2200	0.0829	2,000
NRSA472M50V22x42F	4,700	0.20	2500	0.07	2,000	
NRSA4R7M63V5x11F	4.7	63	0.10	35	31.8	2,000
NRSA100M63V5x11F	10		0.10	60	15.0	2,000
NRSA220M63V6.3x11F	22		0.10	100	6.79	2,000
NRSA330M63V6.3x11F	33		0.10	140	4.53	2,000
NRSA470M63V8x11.5F	47		0.10	190	3.18	2,000
NRSA101M63V10x12.5F	100		0.10	300	1.50	2,000
NRSA151M63V10x16F	150		0.10	400	0.800	2,000
NRSA221M63V10x20F	220		0.10	490	0.679	2,000
NRSA331M63V12.5x20F	330		0.10	680	0.453	2,000
NRSA471M63V12.5x25F	470		0.10	880	0.318	2,000
NRSA102M63V16x31.5F	1,000		0.10	1300	0.150	2,000
NRSA152M63V18x36F	1,500		0.10	1600	0.099	2,000
NRSA222M63V18x35.5F	2,200		0.11	2200	0.083	2,000
NRSA332M63V22x42F	3,300		0.13	2300	0.065	2,000

STANDARD PRODUCT, SPECIFICATIONS AND CASE SIZES D ϕ x L (mm)

Part Number	Cap. (μ F)	W.V. (Vdc)	Dissipation Factor +20°C/120Hz	Ripple Current Rating (mA) +85°C/120Hz	Max. ESR (Ω) +20°C/120Hz	Load Life Hours @ +85°C
NRSAR47M100V5x11F	0.47	100	0.10	11	283	2,000
NRSA1R0M100V5x11F	1.0		0.10	15	133	2,000
NRSA2R2M100V5x11F	2.2		0.10	25	60.4	2,000
NRSA3R3M100V5x11F	3.3		0.10	35	40.3	2,000
NRSA4R7M100V5x11F	4.7		0.10	45	28.3	2,000
NRSA100M100V6.3x11F	10		0.10	70	13.3	2,000
NRSA220M100V8x11.5F	22		0.10	120	6.04	2,000
NRSA330M100V10x12.5F	33		0.10	170	4.03	2,000
NRSA470M100V10x16F	47		0.10	230	2.83	2,000
NRSA101M100V12.5x20F	100		0.10	370	1.33	2,000
NRSA151M100V12.5x20F	150		0.10	490	0.710	2,000
NRSA221M100V16x25F	220		0.10	600	0.604	2,000
NRSA331M100V16x25F	330		0.10	700	0.403	2,000
NRSA471M100V16x31.5F	470		0.10	930	0.283	2,000

RIPPLE CURRENT FREQUENCY CORRECTION FACTOR

Frequency (Hz)	50	120	300	1K	10K
~ 47 μ F	0.75	1.00	1.35	1.57	2.00
100 ~ 470 μ F	0.80	1.00	1.23	1.34	1.50
1,000 μ F ~	0.85	1.00	1.10	1.13	1.15
2,200 ~ 10,000 μ F	0.85	1.00	1.03	1.05	1.08

PART NUMBERING SYSTEM

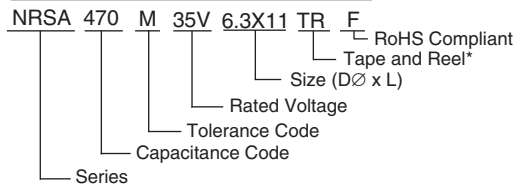

*see taping specifications for details

PRECAUTIONS

Please review the notes on correct use, safety and precautions found on pages T10 & T11 of NIC's Electrolytic Capacitor catalog. Also found at www.niccomp.com/precautions. If in doubt or uncertainty, please review your specific application - process details with NIC's technical support personnel: tpmg@niccomp.com



Miniature Aluminum Electrolytic Capacitors Taping Specifications

STANDARD RADIAL TAPING (5mm LEAD SPACING, FORMED LEADS) TR, TB

Taping Dimensions (mm)

Case Dia. (D ϕ)	4	5	6.3	8
Case Size	4x5 4x7	5x5 5x7	5x11	6.3x5 6.3x7 6.3x11 8x11.5
d ϕ \pm 0.05	0.45	0.45	0.5	0.45
H \pm 0.75	17.5	17.5	18.5	17.5
F +0.8 ~ -0.2	5.0 -0.2 ~ +0.8			
P	12.7 \pm 1.0			
P ₀	12.7 \pm 0.2			
P ₁	3.85 \pm 0.5 (at end of tape)			
P ₂	6.35 \pm 1.0			
W	18.0 \pm 0.5			
W ₀	11.5 min.			
W ₁	9.0 \pm 0.5			
W ₂	0 ~ 2.5			
H ₀	16.0 \pm 0.5			
l	1.0 max.			
D ₀ ϕ	4.0 \pm 0.2			
Δ h	0 \pm 1.0 (at top of can)			
t	0.7 \pm 0.2 (not including lead)			

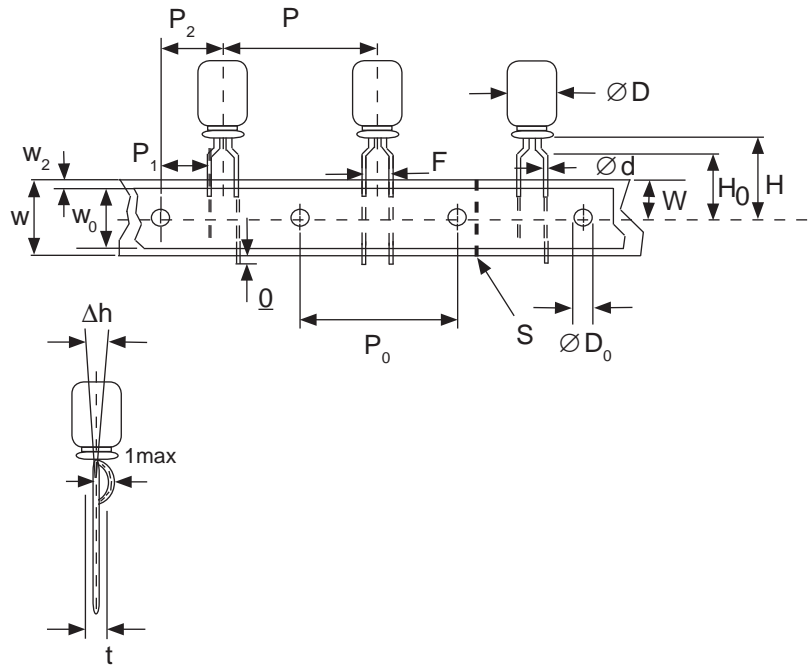

STANDARD RADIAL TAPING (5mm LEAD SPACING, STRAIGHT LEADS) TR, TB

Taping Dimensions (mm)

Case Dia. (D ϕ)	10	12.5
Case Size	All	All
d ϕ \pm 0.05	0.6	0.6
H \pm 0.75	19.0	19.0
F +0.8 ~ -0.2	5.0	5.0
P \pm 1.0	25.4*	
P ₀	12.7 \pm 0.2	
P ₁	3.85	
P ₂	6.35 \pm 1.0	
W	18.0 \pm 0.5	
W ₀	11.5 min	
W ₁	9.0 \pm 0.5	
W ₂	0 ~ 2.5	
H ₀	16.0 \pm 0.5	
l	1.0 max.	
D ₀ ϕ	4.0 \pm 0.2	
Δ h	0 \pm 1.0 (at top of can)	
t	0.7 \pm 0.2 (not including lead)	

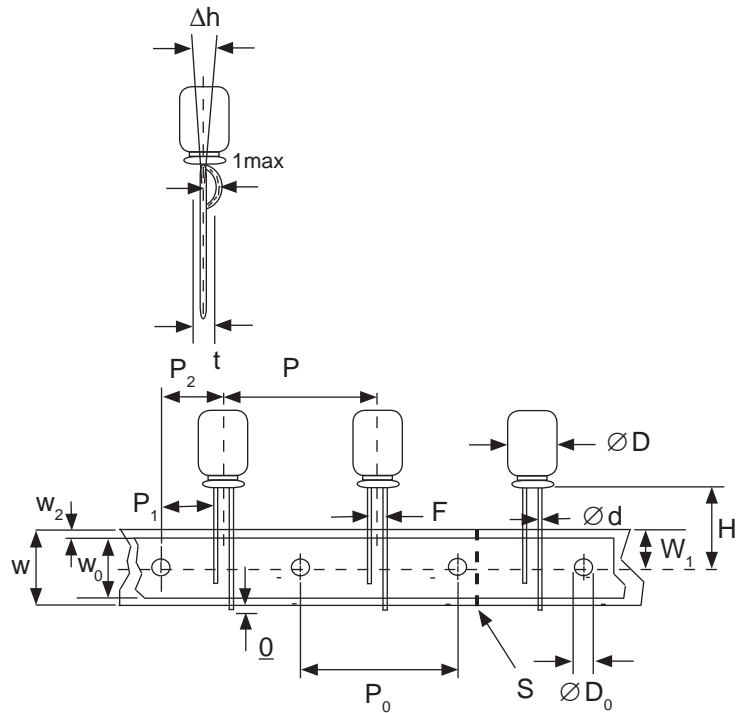

*Optional Taping Specifications

10mm diameter available with P dim. = 12.7mm
(P/N Suffix: TB12.7MMP)

12.5mm diameter available with P dim. = 15mm, P₁ = 5.0mm,
P₀ = 15.0mm & P₂ = 7.5mm (P/N Suffix: TB15MMP)

NOTE: ANODE (+) LEAD FEEDS OFF FIRST.
FOR OPTION OF NEGATIVE (-) LEAD FIRST,
SPECIFY "TRN" OR "TBN".



Miniature Aluminum Electrolytic Capacitors Taping Specifications

SPECIAL RADIAL TAPING (2.5mm LEAD SPACING, FORMED LEADS) TRF1, TBF1

Taping Dimensions (mm)

Case Dia. (D ϕ)	4		5	
Case Size Dim.	4x5 4x7	5x5 5x7	5x11	
d ϕ \pm 0.05	0.45	0.45	0.5	
H \pm 0.75	17.5	17.5	18.5	
H ₀ \pm 0.5	16.0	-	-	
F	2.5 -0.2 ~ +0.8			
P	12.7 \pm 1.0			
P ₀	12.7 \pm 0.2			
P ₁	5.1 \pm 0.5			
P ₂	6.35 \pm 1.0			
W	18.0 \pm 0.5			
W ₀	11.5 min.			
W ₁	9.0 \pm 0.5			
W ₂	0 ~ 1.5			
l	1.0 max.			
D ₀ ϕ	4.0 \pm 0.2			
Δ h	0 \pm 1.0			
t	0.7 \pm 0.2			

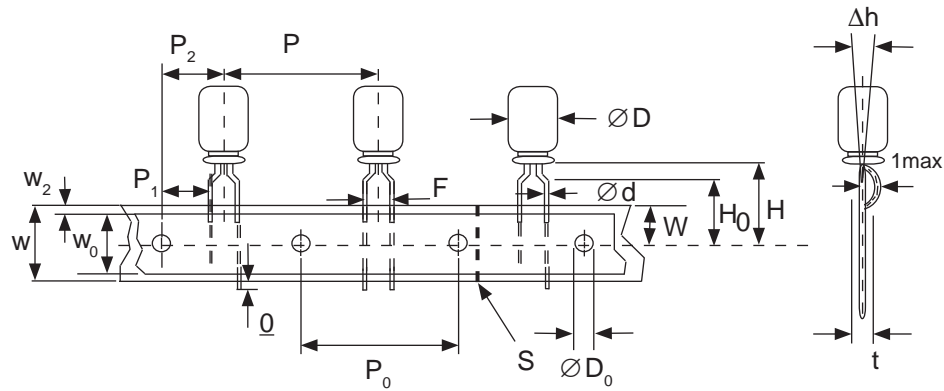

SPECIAL STRAIGHT LEAD TAPING TRST, TBST

Taping Dimensions (mm)

Case Dia. (D ϕ)	4			5			6.3		8	
Case Size Dim.	4x5 4x7	5x5 5x7	5x11		6.3x5 6.3x7	6.3x11		8x11.5		
d ϕ \pm 0.05	0.45	0.45	0.5		0.45	0.5		0.6		
H \pm 0.75	17.5	17.5	18.5		17.5	18.5		20.0		
F \pm 0.8 ~ -0.2	2.0*	2.0	2.0		2.5	2.5		3.5		
P \pm 1.0	12.7 \pm 0.2									
P ₀	12.7 \pm 0.2									
P ₁	5.1	5.1	5.1	5.1	5.1	5.1	4.6			
P ₂	6.35 \pm 1.0									
W	18.0 \pm 0.5									
W ₀	11.5 min.									
W ₁	9.0 \pm 0.5									
W ₂	0 ~ 2.5									
H ₀	16.0 \pm 0.5									
l	1.0 max.									
D ₀ ϕ	4.0 \pm 0.2									
Δ h	0 \pm 1.0 (at top of can)									
t	0.7 \pm 0.2 (not including lead)									

* Parts with 4mm diameter are taped with a slight flare in the lead and a 2.0mm lead-space.

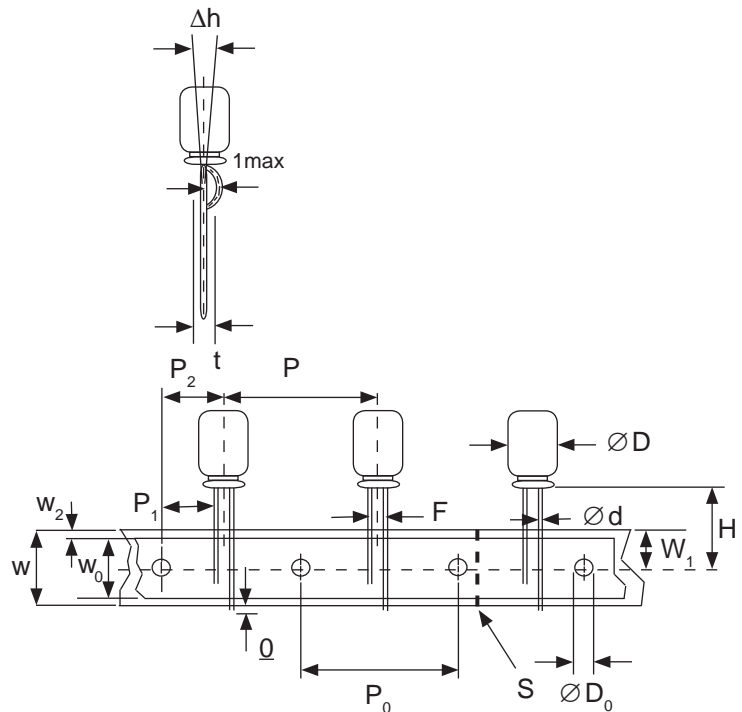

RADIAL TAPED PACKAGING

Ammo Box (Tape & Box) TB, TBF, TBST

Size of box and component quantity

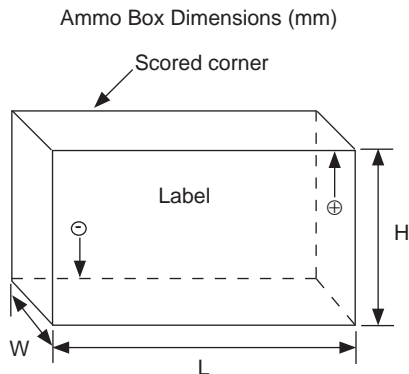

Case Dia (D ϕ) or Case Size	Q'ty per Box (pcs)	Dim. L	Dim. H	Dim. W
4x5, 4x7	2,000	331	175	43
5x5, 5x7	2,000	331	220	43
5x11	2,000	340	255	55
6.3x5, 6.3x7	2,000	331	280	43
6.3x11	2,000	331	280	48
8x11.5, 8x12.5	1,000	335	235	53
10x12.5*	500	335	190	53
10x16*	500	335	300	53
10x20*	500	335	300	55
12.x20*	500	335	300	55
12.5x25*	500	335	300	61

*Special Taping Consult Factory For Availability

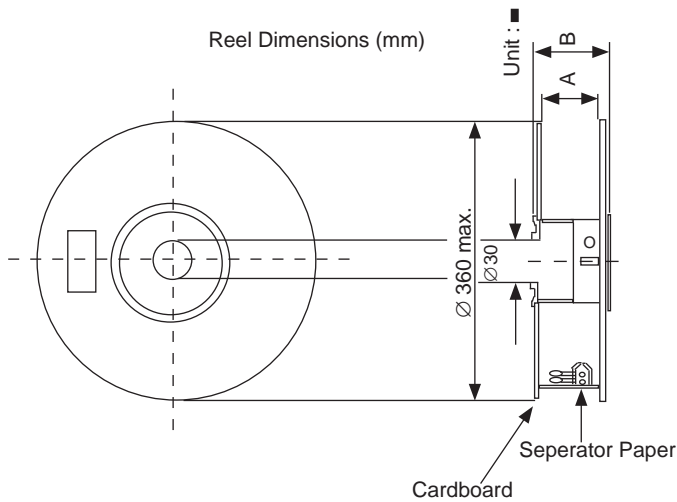

Reel Packages (Tape & Reel) TR, TRF1, TRST

Size of reel and component quantity

Case Dia (D ϕ) or Case Size	Q'ty per Box (pcs)	Dim. A	Dim. B
4 ϕ	1,800	42	52
5 ϕ	1,500	42	52
6.3 ϕ	1,000	42	52
8 ϕ	800	42	52
10x12.5*	600	42	52
10x16*	600	48	56
10x20*	600	52	60
12.x20*	250	52	60
12.5x25*	250	56	64

*Special Taping Consult Factory For Availability