



**SERIES: VFM-XX**

**DESCRIPTION: DC EMI FILTER**

**FEATURES**

- compact size
- suitable for use with a wide range of dc-dc converters
- reduces common and differential mode noise



MODEL	input voltage	input surge voltage <sup>1</sup>	input current	isolation voltage <sup>2</sup>
	range (V dc)	nominal (V dc)	max. (A)	min. (V dc)
VFM-10A	0 ~ 75	100	10	1,500
VFM-15C	0 ~ 75	100	15	1,500
VFM-20A	0 ~ 75	100	20	1,500
VFM-25C	0 ~ 36	50	25	1,500

1) for 100 ms  
2) input to ground, output to ground

**GENERAL**

parameter	conditions/description	min	nom	max	units
dimensions	VFM-10A: 2.00x1.00x0.46 inch 50.8x25.4x11.7 mm VFM-15C: 4.06x3.11x0.89 inch 103.2x79x22.7 mm VFM-20A: 2.00x1.60x0.50 inch 50.8x40.6x12.7 mm VFM-25C: 4.06x3.11x0.89 inch 103.2x79x22.7 mm				
case material	VFM-10A/20A: black plastic VFM-15C/25C: black coated steel				
isolation voltage	input to ground, output to ground	1,500			V dc
isolation resistance	input to ground, output to ground	10 <sup>7</sup>			Ω
dc resistance	total for two legs		16		mΩ

**ENVIRONMENTAL**

parameter	conditions/description	min	nom	max	units
cooling	natural convection				
operating temperature		-40		100	°C
case temperature				100	°C
storage temperature		-40		100	°C



SERIES: VFM-XX

DESCRIPTION: DC EMI FILTER

DRAWING (VFM-10A)

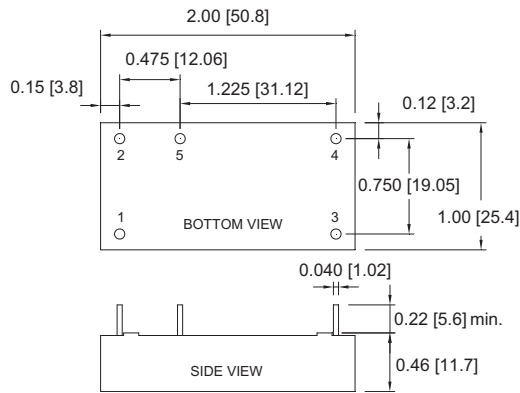

NOTE: Pin Size is  $\varnothing 0.04$  inch ( $\varnothing 1.02$  mm)  
 All Dimensions in inches (mm)  
 Tolerances: Inches: X.XX=  $\pm 0.02$ , X.XXX=  $\pm 0.010$   
 Millimeters: X.X=  $\pm 0.5$ , X.XX=  $\pm 0.25$

PIN CONNECTION	
Pin	Function
1	+V Input
2	-V Input
3	+V Output
4	-V Output
5	GND

DRAWING (VFM-20A)

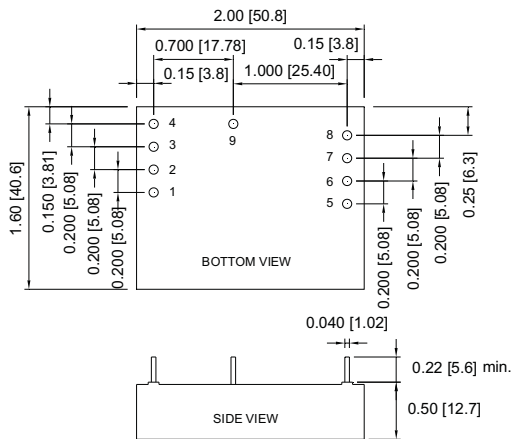

DIMENSIONS:  
 NOTE: Pin Size is  $\varnothing 0.04$  inch ( $\varnothing 1.02$  mm)  
 All Dimensions in inches (mm)  
 Tolerances Inches: X.XX=  $\pm 0.02$ , X.XXX=  $\pm 0.010$   
 Millimeters: X.X=  $\pm 0.5$ , X.XX=  $\pm 0.25$

PIN CONNECTION	
Pin	Function
1,2	+V Input
3,4	-V Input
5,6	+V Output
7,8	-V Output
9	GND



SERIES: VFM-XX

DESCRIPTION: DC EMI FILTER

DRAWING (VFM-15C/25C)

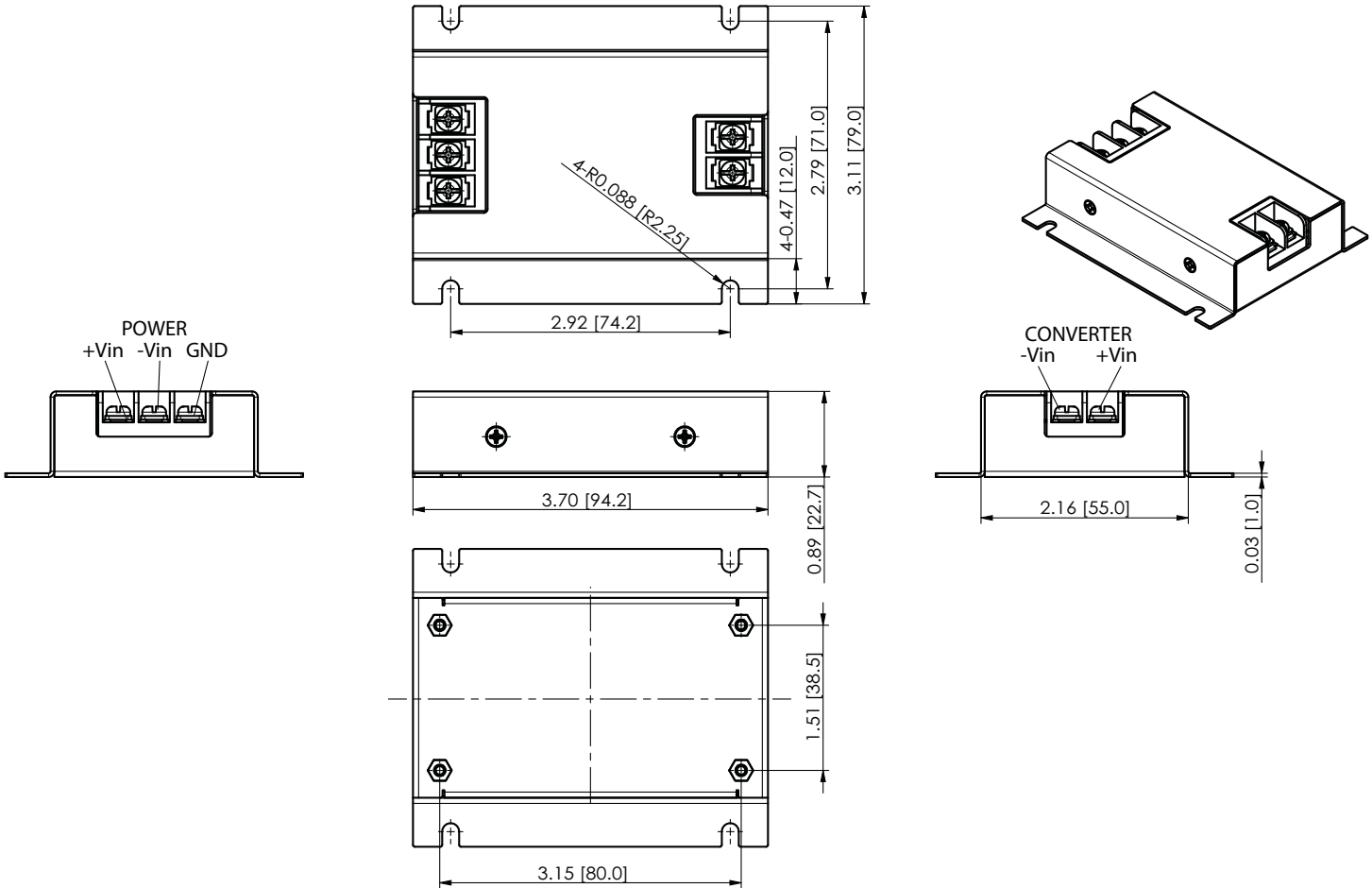



SERIES: VFM-XX

DESCRIPTION: DC EMI FILTER

### VFM-10A INTERNAL SCHEMATIC

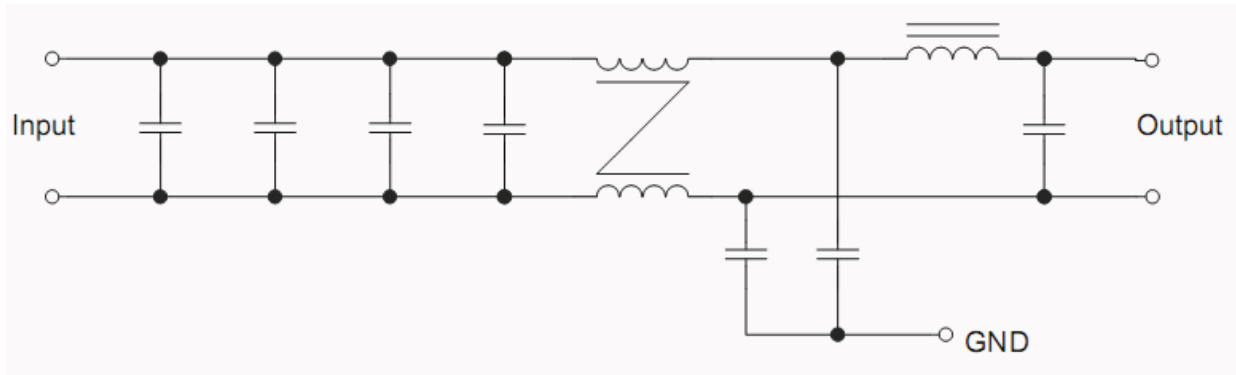

### VFM-20A INTERNAL SCHEMATIC

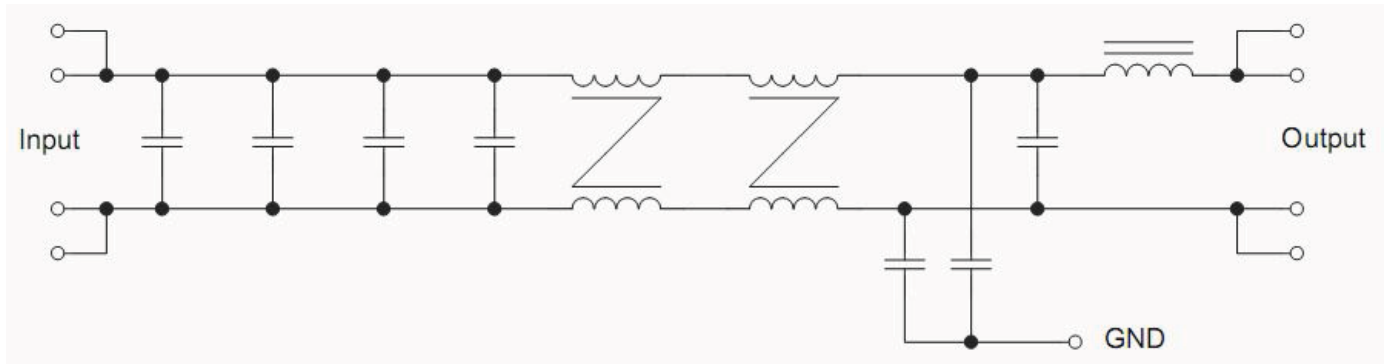

### VFM-15C/25C INTERNAL SCHEMATIC

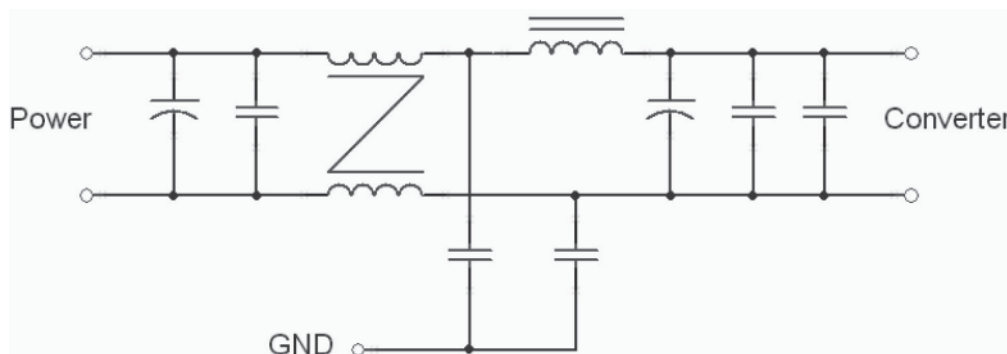



SERIES: VFM-XX

DESCRIPTION: DC EMI FILTER

**INSERTION LOSS (VFM-10A)**

**COMMON MODE**

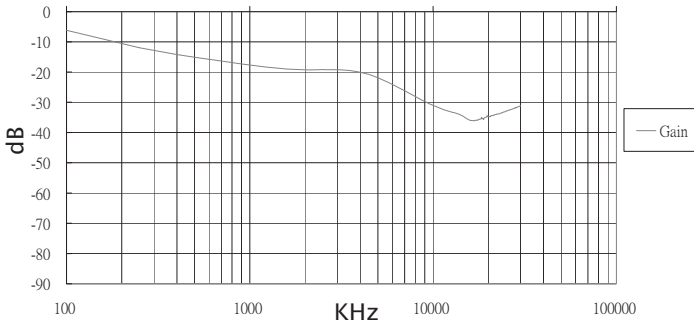

**DIFFERENTIAL MODE**

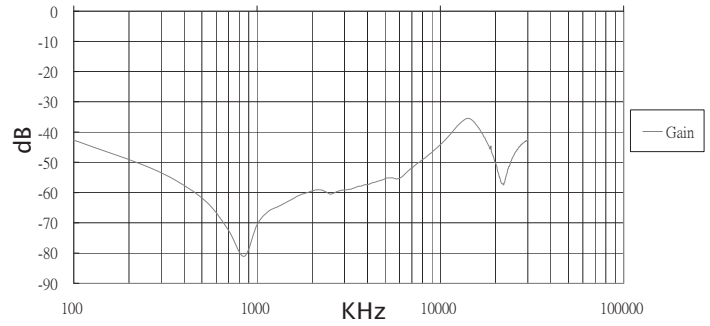

**INSERTION LOSS (VFM-15C)**

**COMMON MODE**

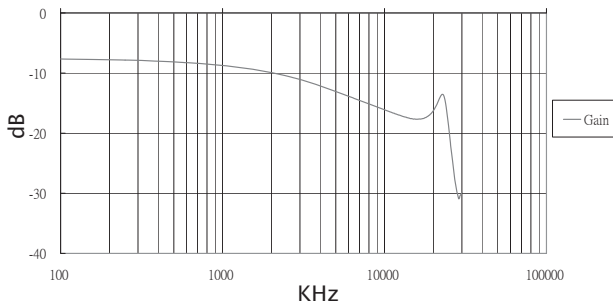

**DIFFERENTIAL MODE**

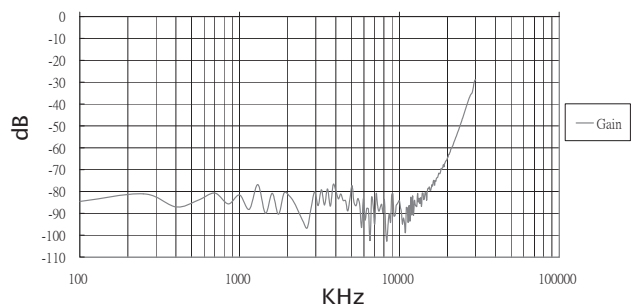

**INSERTION LOSS (VFM-20A)**

**COMMON MODE**

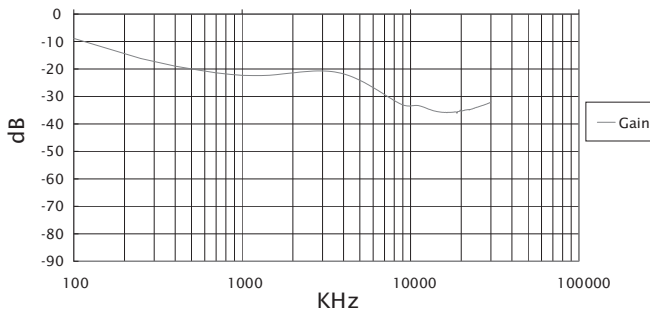

**DIFFERENTIAL MODE**

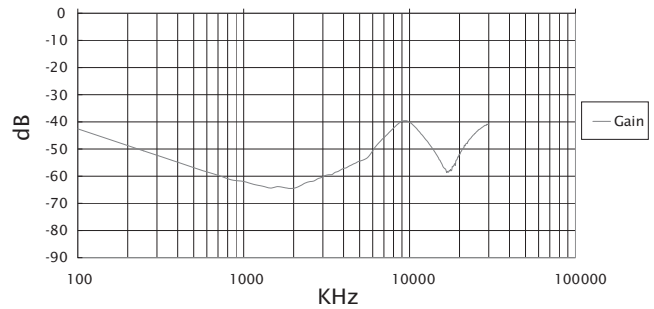



SERIES: VFM-XX

DESCRIPTION: DC EMI FILTER

**INSERTION LOSS (VFM-25C)**

**COMMON MODE**

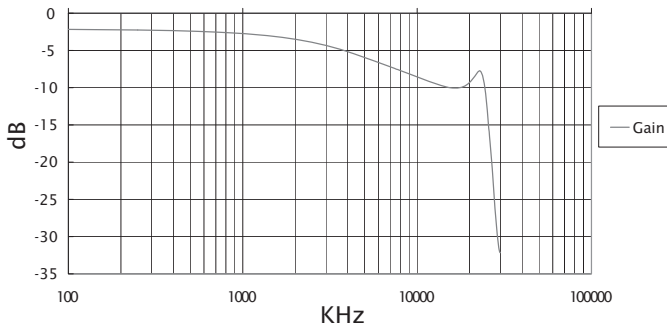

**DIFFERENTIAL MODE**

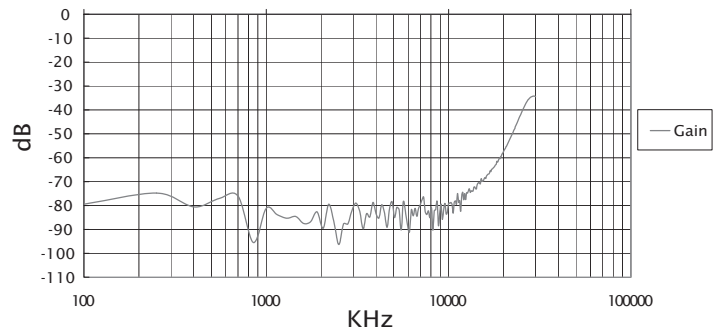

**APPLICATION NOTES**

The following application note shows EN55022 class B conducted emissions tests for the VFM-XX series EMI filters in series with a VHK or VHB series DC/DC converter and a purely resistive load. This information is for example only. Actual results may vary.

1) EMI Filtering - Connection Diagram

Filter Model (VFM-XX)	DC-DC Converter Model (VHXXXW)	C1	C2	CY1	CY2	CY3	CY4
VFM-10A	VHB50W-Q24-S5	47 $\mu$ F/100 V KY	...	...	...	...	...
	VHB50W-Q48-S5	47 $\mu$ F/100 V KY	...	...	...	...	...
VFM-15C	VHK200W	...	...	...	...	...	...
VFM-20A	VHB150W-Q24-S5	47 $\mu$ F/100 V KY	220 $\mu$ F/100 V KY	1000 pF / 2 KV	...	1000 pF / 2 KV	560 pF/2 KV
	VHB150W-Q48-S5	...	220 $\mu$ F/100 V KY	1000 pF / 2 KV	...	1000 pF / 2 KV	560 pF/2 KV
VFM-25C	VHK200W	...	...	...	...	...	...

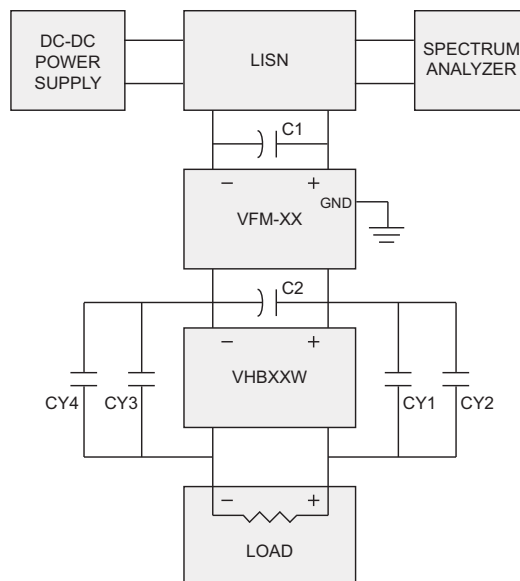



**SERIES: VFM-XX**

**DESCRIPTION: DC EMI FILTER**

**2) Conducted Emission Measurement**

**Filter Model: VFM-10A**  
DC-DC Converter Model: VHB50W-Q24-S5  
Input Voltage: 12 V dc

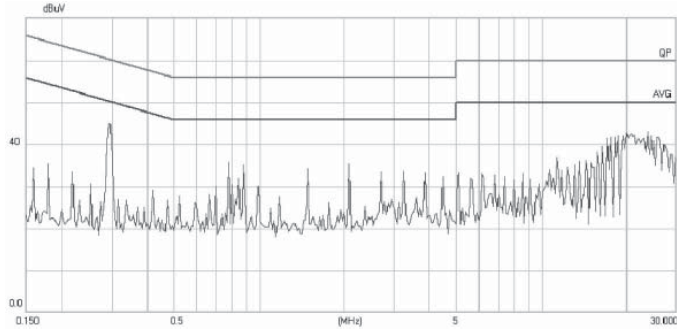

**Filter Model: VFM-20A**  
DC-DC Converter Model: VHB150W-Q24-S5  
Input Voltage: 12 V dc

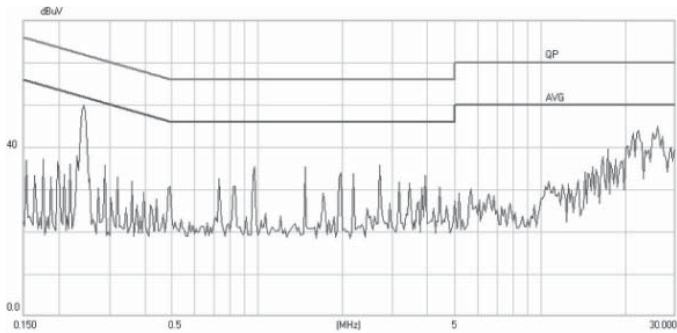

**Filter Model: VFM-15C**  
DC-DC Converter Model: VHK200W-Q48-S12  
Input Voltage: 48 V dc

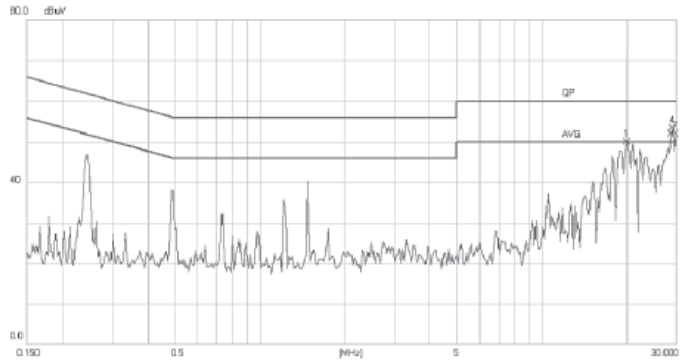

**Filter Model: VFM-25C**  
DC-DC Converter Model: VHK200W-Q24-S12  
Input Voltage: 24 V dc

