

Small-sized Side-operational SMD Light Touch Switches

Type: **EVQPU**

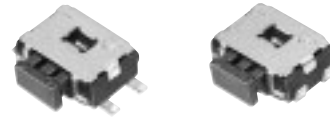

■ Features

- External dimensions : 4.7 mm×3.5 mm, Height 1.65 mm
- A wide range of terminal type : J-bent, Straight

■ Recommended Applications

- Car navigation, Car audio

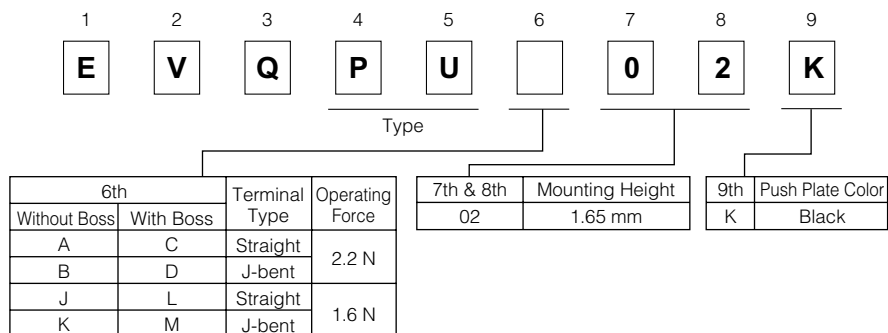

■ Explanation of Part Numbers



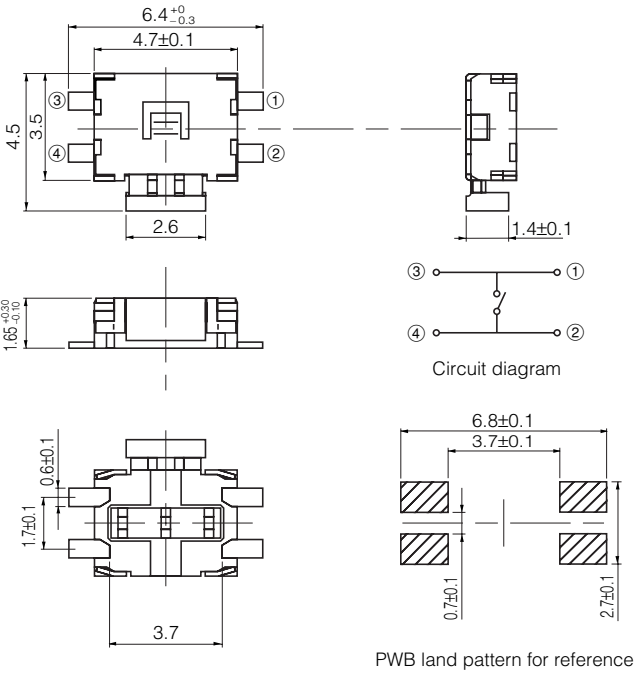

■ Specifications

Type		Snap action / Push-on type SPST	
Electrical	Rating	10 μA 2 Vdc to 50 mA 12 Vdc (Resistive load)	
	Contact Resistance	500 mΩ max.	
	Insulation Resistance	100 MΩ min. (at 100 Vdc)	
	Dielectric Withstanding Voltage	250 Vac for 1 minute	
	Bouncing	10 ms max. (ON, OFF)	
Mechanical	Operating Force	1.6 N ^{+0.7} _{-0.4} N	2.2 N ^{+0.8} _{-0.7} N
	Travel	0.3 mm ^{+0.1} _{-0.2} mm	
	Push Strength	30 N (1 minute)	
Endurance	Operating Life	100000 cycles min.	
Operating Temperature		-20 °C to +70 °C	
Storage Temperature		-40 °C to +85 °C (Bulk) -20 °C to +60 °C (Taping)	
Minimum Quantity/Packing Unit		4000 pcs. Embossed Taping (Reel Pack)	
Quantity/Carton		20000 pcs.	

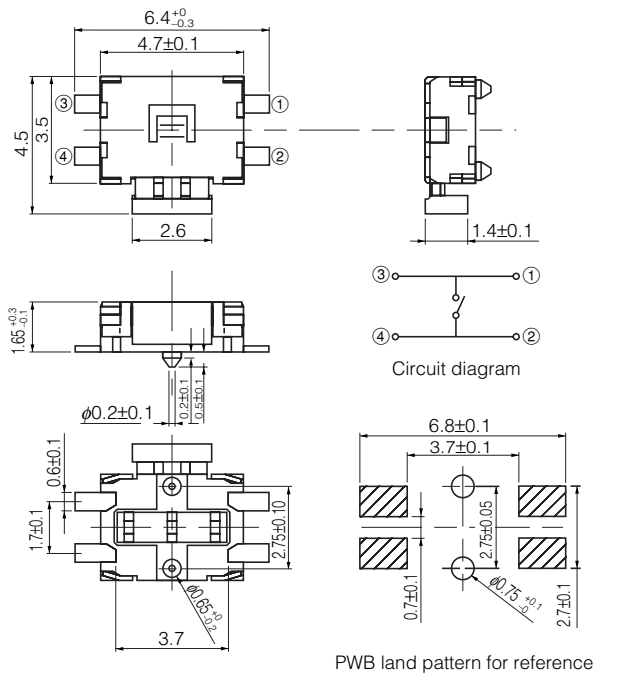
■ Dimensions in mm (not to scale)

<p>No. 1</p> <p>EVQPUJ EVQPUA</p> <p>(Embossed Taping)</p> <p>With straight terminals Without boss</p> 				
<p>Part Numbers</p>	<p>Operating Force</p>	<p>Height</p>	<p>Push Plate Color</p>	<p>Operating Life</p>
<p>EVQPUJ02K</p>	<p>1.6 N</p>	<p>1.65 mm</p>	<p>Black</p>	<p>100000 cycles</p>
<p>EVQPUA02K</p>	<p>2.2 N</p>	<p>1.65 mm</p>	<p>Black</p>	<p>100000 cycles</p>
<p>No. 2</p> <p>EVQPUL EVQPUC</p> <p>(Embossed Taping)</p> <p>With straight terminals With boss</p> 				
<p>Part Numbers</p>	<p>Operating Force</p>	<p>Height</p>	<p>Push Plate Color</p>	<p>Operating Life</p>
<p>EVQPUL02K</p>	<p>1.6 N</p>	<p>1.65 mm</p>	<p>Black</p>	<p>100000 cycles</p>
<p>EVQPUC02K</p>	<p>2.2 N</p>	<p>1.65 mm</p>	<p>Black</p>	<p>100000 cycles</p>

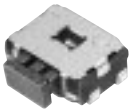
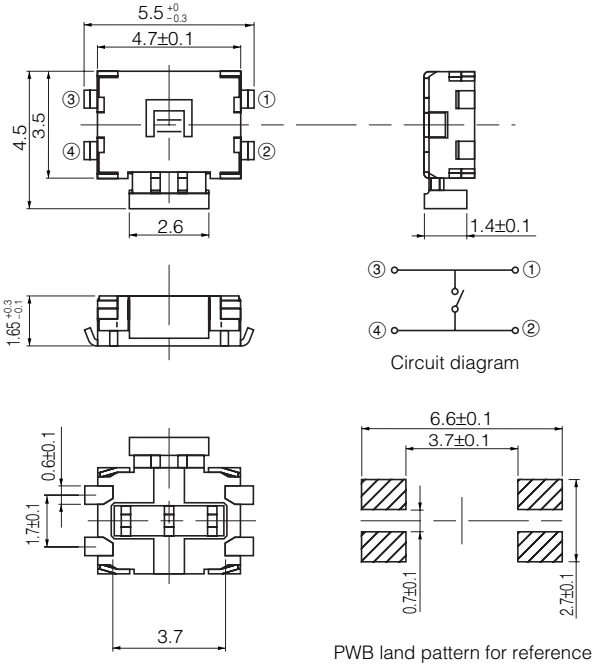
■ Dimensions in mm (not to scale)

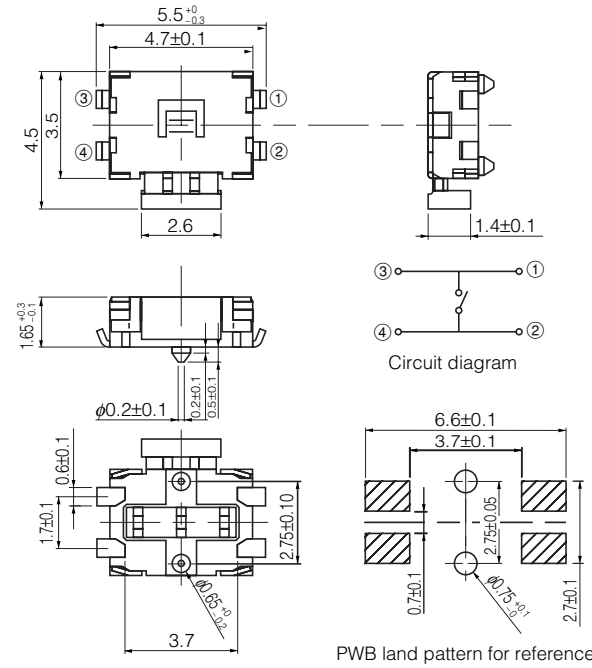
<p>No. 3</p> <p>EVQPUK EVQPUB</p> <p>(Embossed Taping)</p> <p>With J-bent terminals Without boss</p> 				
<p>Part Numbers</p>	<p>Operating Force</p>	<p>Height</p>	<p>Push Plate Color</p>	<p>Operating Life</p>
<p>EVQPUK02K</p>	<p>1.6 N</p>	<p>1.65 mm</p>	<p>Black</p>	<p>100000 cycles</p>
<p>EVQPUB02K</p>	<p>2.2 N</p>	<p>1.65 mm</p>	<p>Black</p>	<p>100000 cycles</p>
<p>No. 4</p> <p>EVQPUM EVQPUD</p> <p>(Embossed Taping)</p> <p>With J-bent terminals With boss</p> 				
<p>Part Numbers</p>	<p>Operating Force</p>	<p>Height</p>	<p>Push Plate Color</p>	<p>Operating Life</p>
<p>EVQPUM02K</p>	<p>1.6 N</p>	<p>1.65 mm</p>	<p>Black</p>	<p>100000 cycles</p>
<p>EVQPUD02K</p>	<p>2.2 N</p>	<p>1.65 mm</p>	<p>Black</p>	<p>100000 cycles</p>

■ Recommended Reflow Soldering Conditions

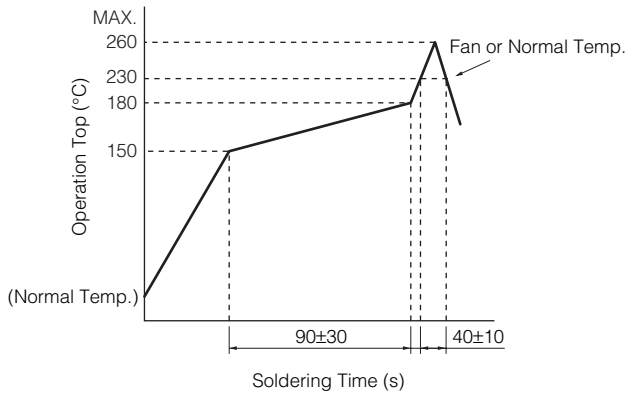

● Embossed Carrier Taping

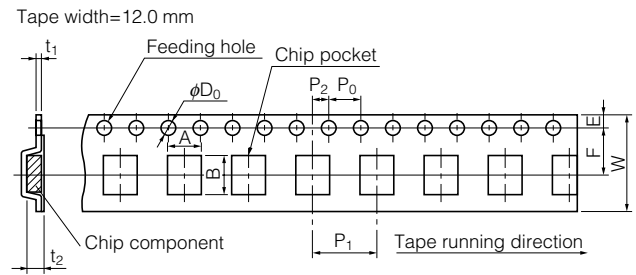

Unit: mm

Part No.	Height	A	B	W	F	E	P ₁	P ₂	P ₀	D ₀ Dia.	t ₁	t ₂
EVQPU	1.65	7.0±0.2	5.75±0.20	12.0±0.3	5.78±0.20	1.75±0.10	8.0±0.1	2.0±0.1	4.0±0.1	1.5 ^{+0.1} ₀	0.35±0.05	2.4±0.2

● Standard Reel Dimensions in mm (not to scale)

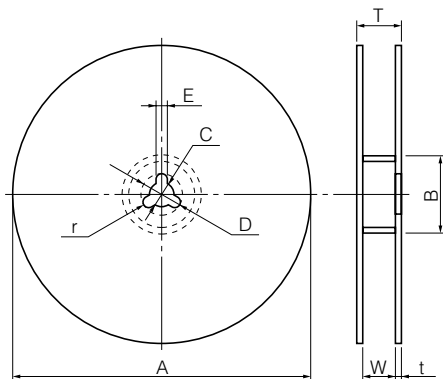

Item	A	B	C	D	E
Rate (mm)	φ370.0±2.0	φ50.0 min.	φ13.0±0.5	φ21.0±1.0	2.0±0.5

Item	W	T	t	r
Rate (mm)	14.0±1.5	—	1.0 to 3.0	1.0±0.5