

## Data Sheet | Item Number: 222-413

CLASSIC Splicing Connector; for all conductor types; max. 4 mm<sup>2</sup>; 3-conductor;  
with levers; gray housing; Surrounding air temperature: max 40°C; 2,50 mm<sup>2</sup>; gray



<https://www.wago.com/222-413>



Color: ■ gray

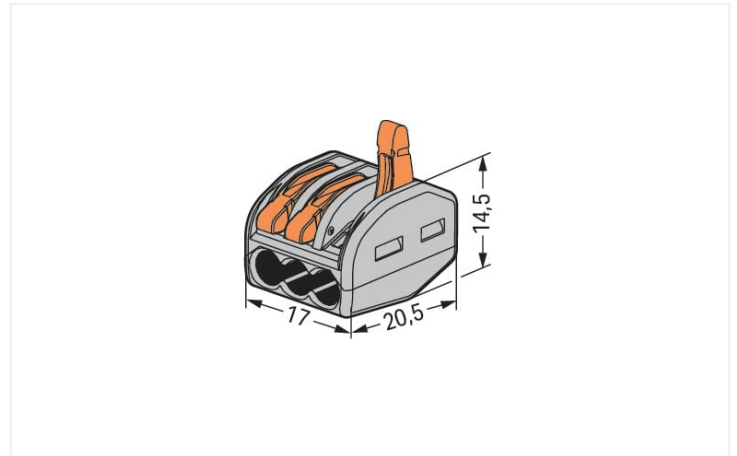

Dimensions in mm

### Notes

Safety information 1

in grounded power lines

### Electrical data

#### Ratings per IEC/EN

Ratings per	EN 60664
Nominal voltage (II/2)	400 V
Rated surge voltage (II/2)	4 kV
Rated current	32 A
Legend (ratings)	(II / 2) $\triangleq$ Overvoltage category II / Pollution degree 2

### Connection data

Connection points	3
Total number of potentials	1

#### Connection 1

Connection technology	CAGE CLAMP®
Actuation type	Lever
Connectable conductor materials	Copper
Solid conductor	0.08 ... 2.5 mm <sup>2</sup> / 28 ... 12 AWG
Wiring direction	Side-entry wiring

## Material Data

Note (material data)

[Information on material specifications can be found here](#)

Color	gray
Flammability class per UL94	V0
Fire load	0.099 MJ
Actuator color	orange
Weight	4.3 g

## Commercial data

Product Group	7 (Push Wire Conn.)
eCl@ss 10.0	27-14-11-04
eCl@ss 9.0	27-14-11-04
ETIM 8.0	EC000446
ETIM 7.0	EC000446
PU (SPU)	500 (50) pcs
Packaging type	Box
Country of origin	DE
GTIN	4017332955676
Customs tariff number	85369010000

## Approvals / Certificates

### General approvals



Approval	Standard	Certificate Name
ENEC 15 UL International Demko A/S	EN 60998	ENEC-01360
UL_Listed_64KA UL International Germany GmbH	UL 467	E201573
UL UL International Germany GmbH	UL 486C	E69654

### Approvals for marine applications



Approval	Standard	Certificate Name
ABS American Bureau of Shipping	-	18-HG1755093-PDA
DNV GL Det Norske Veritas, Germanischer Lloyd	EN 60998	TAE000015T
LR Lloyds Register	EN 60998	LR22207029TA

## Downloads

### Environmental Product Compliance

#### Compliance Search

 Environmental Product  
 Compliance 222-413
 

## Documentation

Bid Text			
222-413	19.02.2019	xml 3.37 KB	↓
222-413	23.01.2019	docx 15.39 KB	↓

CAD/CAE-Data	
<b>CAD data</b>	<b>CAE data</b>
2D/3D Models 222-413 ↓	EPLAN Data Portal 222-413 ↓
	WSCAD Universe 222-413 ↓
	ZUKEN Portal 222-413 ↓

## 1 Compatible Products

### 1.1 Optional Accessories

#### 1.1.1 Mounting adapter

##### 1.1.1.1 Mounting accessories



**Item No.: 222-500**  
 Mounting carrier; 222 Series; for DIN-35 rail mounting/screw mounting; orange

## Installation Notes

### Conductor termination

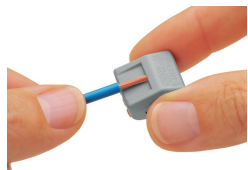

Strip conductor to 9 ... 10 mm (0.35 ... 0.39 inch).

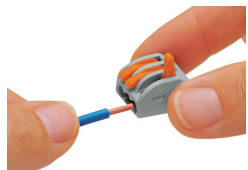

Termination: Lift the lever to open the clamping unit and insert a stripped conductor.

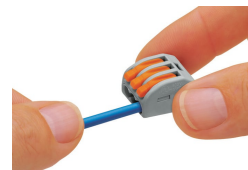

Then, lower the lever to close the clamp.

## Testing



Testing via Profi-LED+ voltage tester (206-806).

## Application

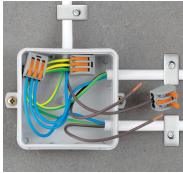

Wiring fine-stranded conductors in junction boxes.



Custom low-voltage lighting system

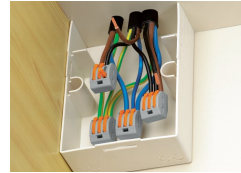

Connecting pre-wired and pre-fabricated components (e.g., in mobile homes).

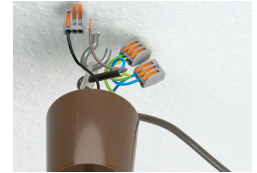

Lighting fixture connection with fine-stranded wires and power feed



Compact, lever-operated splicing connectors:

They connect up to five stripped, fine-stranded conductors from 0.08 to 4 mm<sup>2</sup> (28 ... 12 AWG), as well as solid or stranded conductors from up to 2.5 mm<sup>2</sup> (12 AWG) – without tools!

How they work:

Pull up one of the orange operating levers to open the clamping unit so that the lever engages and keeps the clamp in its opened position. Then insert the conductor and push the lever back down, flush with the connector housing.

Safety:

The lever's specially designed rest position reliably prevents accidental unclamping of a connected conductor. Application safety, for any type of conductor (solid, stranded, fine-stranded), is confirmed by approvals like ENEC or UL.

ENEC is the European mark for electrical products that demonstrates compliance with European safety standards. The ENEC mark is subjected to the same EN standards as the VDE mark.

While the VDE mark is only permitted in Germany, the ENEC mark is accepted in more than 20 European countries.