

VERTICAL PCB MOUNT

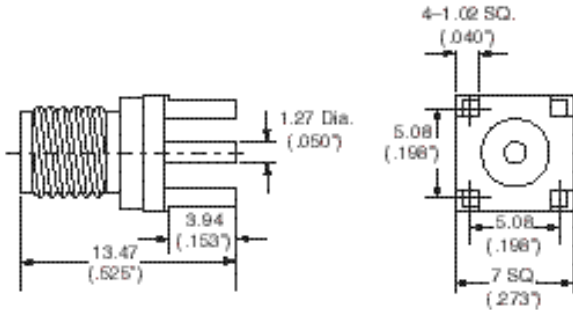

CONREVSMA001

RIGHT ANGLE PCB MOUNT

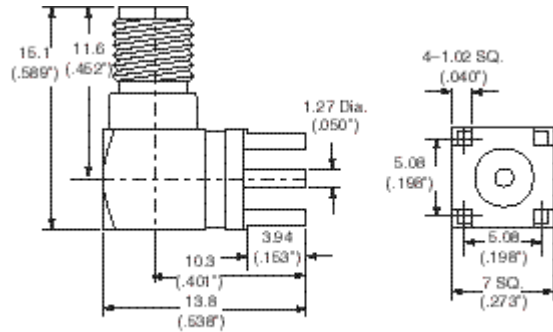

CONREVSMA002

VERTICAL PCB MOUNT

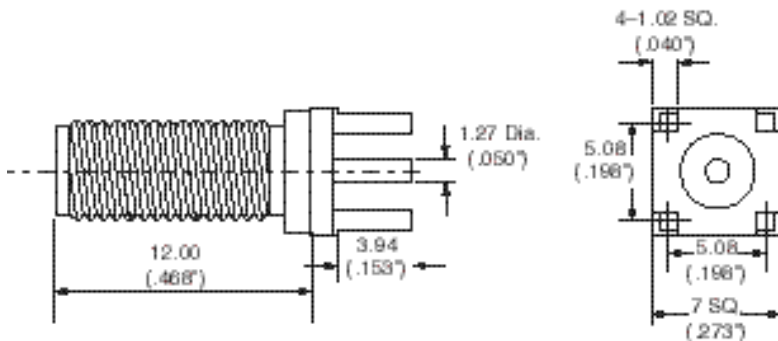

CONREVSMA008

HORIZONTAL PCB EDGE MOUNT

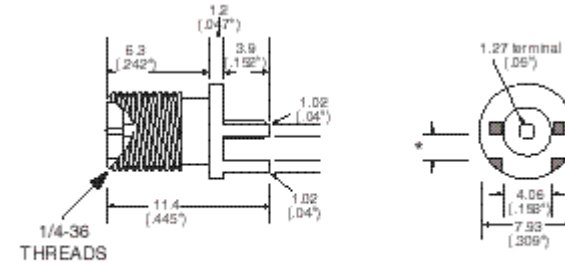

CONREVSMA003.031 for .031 Board Thickness
CONREVSMA003.062 for .062 Board Thickness

MULTI-MOUNT HORIZONTAL PCB

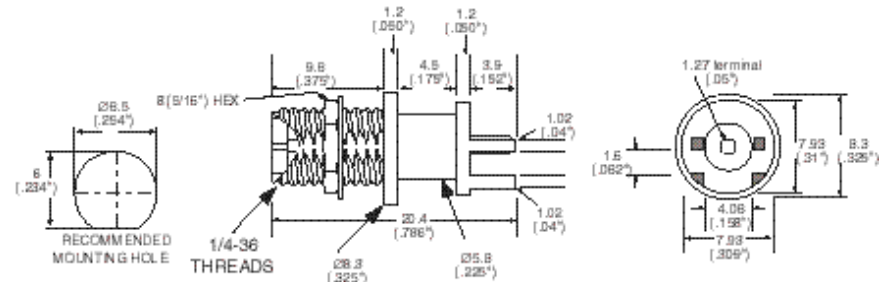

Mounting Options

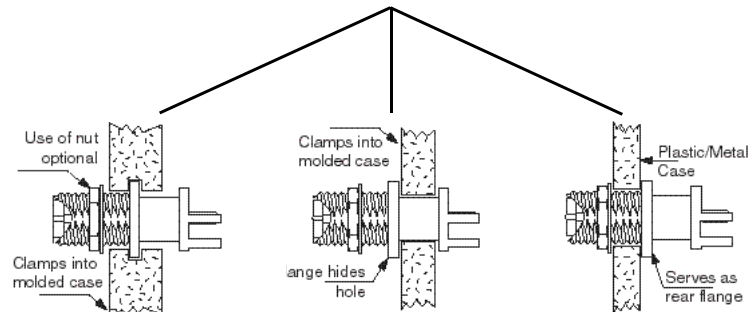

CONREVSMA006

FRONT MOUNT BULKHEAD RECEPTACLE

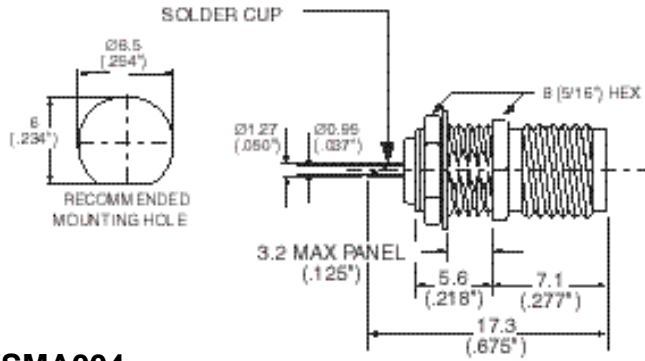

CONREVSMA004

CABLE END - FEMALE - FOR RG-174

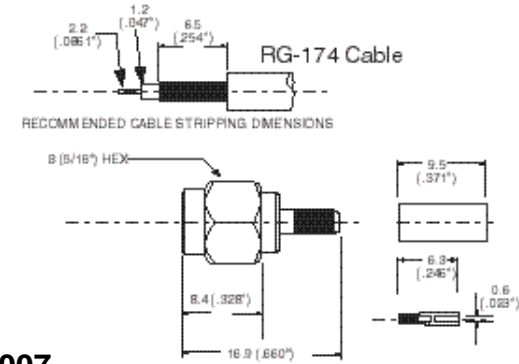

CONREVSMA007

CABLE END - MALE FOR RG-174

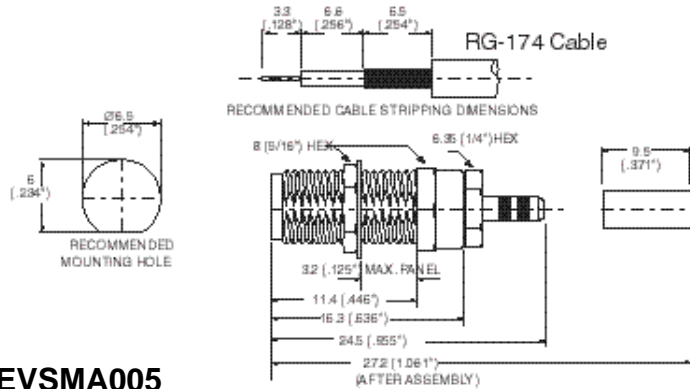

CONREVSMA005

PRE-ASSEMBLED MALE BULKHEAD-WITH RG-174

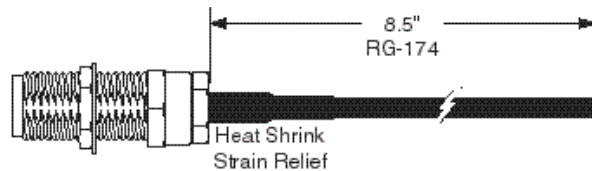

CONREVSMA005-C08.5 (8.5" STANDARD)

CONREVSMA005-CXX.XX (XX.XX=CUSTOM LENGTH, 1K MIN. ORDER)