

8192 word × 8-bit High Speed CMOS Static RAM

Description

CXK5863AP/AJ are 65,536 bits high speed CMOS static RAMS organized as 8,192 words by 8-bits and operate from a single 5V supply. These devices are suitable for use in high speed applications such as cash memory.

Features

- Fast access time 20ns/25ns/30ns (Max.)
- Low power operation 250mW (Typ.)
- Single + 5V supply : 5V ± 10%
- Fully static memory...No clock or timing strobe required.
- Equal access and cycle time.
- Common data input and output three state output.
- Directly TTL compatible all inputs and outputs.
- Full CMOS.
- Compatible with various types of packages
CXK5863AP 300mil 28pin DIP package
CXK5863AJ 300mil 28pin SOJ package

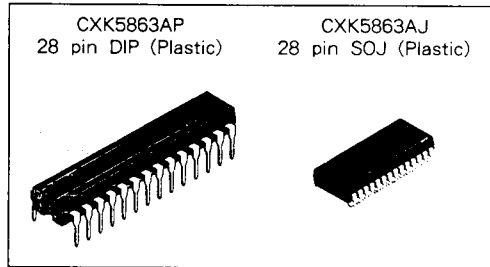

Structure

Silicon gate CMOS IC

Function

8192 word × 8-bit static RAM

Block Diagram

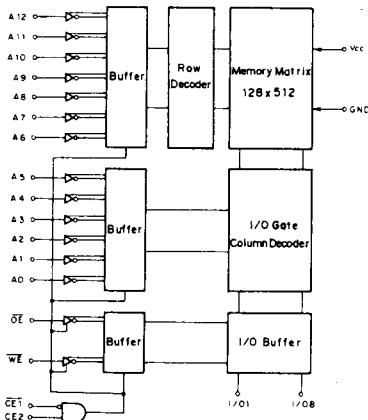

Pin Configuration (Top View)

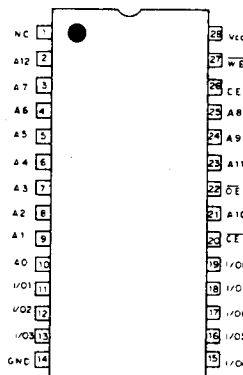

Pin Description

Symbol	Description
A0 to A12	Address input
I/O1 to I/O8	Data input output
CE1, CE2	Chip enable 1, 2 input
WE	Write enable input
OE	Output enable input
Vcc	+ 5V Power supply
GND	Ground
NC	Non connection

Absolute Maximum Ratings

(Ta = 25°C, GND = 0V)

Item	Symbol	Rating	Unit
Supply voltage	V _{CC}	- 0.5* to + 7.0	V
Input voltage	V _{IN}	- 0.5* to V _{CC} + 0.5	V
Input and output voltage	V _{I/O}	- 0.5* to V _{CC} + 0.5	V
Allowable power dissipation	P _D	1.0	W
Operating temperature	T _{opr}	0 to + 70	°C
Storage temperature	T _{stg}	- 55 to + 150	°C
Soldering temperature • time	T _{solder}	260 • 10	°C • sec

* V_{CC}, V_{IN}, V_{I/O} = - 3.5V Min. for pulse width less than 20ns.

Truth Table

CE1	CE2	\overline{OE}	\overline{WE}	Mode	I/O1 to I/O8	V _{CC} Current
H	X	X	X	Not selected	High Z	I _{S1} , I _{S2}
X	L	X	X	Not selected	High Z	I _{S1} , I _{S2}
L	H	H	H	Output disable	High Z	I _{CC1} , I _{CC2}
L	H	L	H	Read	Data out	I _{CC1} , I _{CC2}
L	H	X	L	Write	Data in	I _{CC1} , I _{CC2}

X : "H" or "L"

DC Recommended Operating Conditions

(Ta = 0 to + 70°C, GND = 0V)

Item	Symbol	Min.	Typ.	Max.	Unit
Supply voltage	V _{CC}	4.5	5.0	5.5	V
Input high voltage	V _{IH}	2.2	—	V _{CC} + 0.3	V
Input low voltage	V _{IL}	- 0.3*	—	0.8	V

* V_{IL} = - 3.0V Min. for pulse width less than 20ns.

Electrical Characteristics

DC and operating characteristics

(V_{CC} = 5V ± 10%, GND = 0V, T_a = 0 to +70 °C)

Item	Symbol	Test condition	- 20			- 25 / - 30			Unit
			Min.	Typ.*	Max.	Min.	Typ.*	Max.	
Input leakage current	I _{LI}	V _{IN} = GND to V _{CC}	- 1	—	1	- 1	—	- 1	μA
Output leakage current	I _{LO}	V _{I/O} = GND to V _{CC} , CE1 = V _{IH} or CE2 = V _{IL} or OE = V _{IH} or WE = V _{IL}	- 1	—	1	- 1	—	1	μA
Operating power supply current	I _{CC1}	CE1 = V _{IL} , CE2 = V _{IH} , V _{IN} = V _{IH} or V _{IL} , I _{OUT} = 0mA	—	50	80	—	50	80	mA
Average operating current	I _{CC2}	Cycle = Min, Duty = 100%, I _{OUT} = 0mA	—	95	130	—	70	90	mA
Standby current	I _{SB1}	CE1 ≥ V _{CC} - 0.2V or CE2 ≤ 0.2V V _{IN} ≥ V _{CC} - 0.2V or V _{IN} ≤ 0.2V	—	—	1	—	—	1	mA
	I _{SB2}	CE1 = V _{IH} or CE2 = V _{IL} , V _{IN} = V _{IL} or V _{IH}	—	10	25	—	10	25	mA
Output high voltage	V _{OH}	I _{OH} = - 4.0mA	2.4	—	—	2.4	—	—	V
Output low voltage	V _{OL}	I _{OL} = 8.0mA	—	—	0.4	—	—	0.4	V

* V_{CC} = 5V, T_a = 25 °C

I/O capacitance

(T_a = 25 °C, f = 1MHz)

Item	Symbol	Test conditions	Min.	Max.	Unit
Input capacitance	C _{IN}	V _{IN} = 0V	—	7	pF
I/O capacitance	C _{I/O}	V _{I/O} = 0V	—	7	pF

Note) This parameter is sampled and is not 100% tested.

AC characteristics

● AC test conditions

(V_{CC} = 5V ± 10%, T_a = 0 to +70 °C)

Item	Conditions
Input pulse high level	V _{IH} = 3.0V
Input pulse low level	V _{IL} = 0V
Input rise time	t _r = 5ns
Input fall time	t _f = 5ns
Input and output reference level	1.5V
Output load conditions	Fig. 1

Output Load (1)

Output Load (2) *2

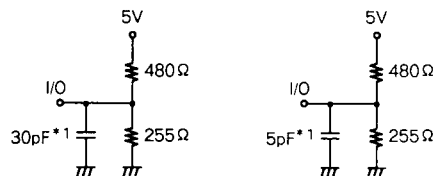

*1 including scope and jig capacitance

*2 for t_{LLZ1}, t_{LLZ2}, t_{OLZ}, t_{HZ1}, t_{HZ2}, t_{OHZ}, t_{OW}, t_{WHZ}

Fig. 1

1) Read cycle

Item	Symbol	- 20		- 25		- 30		Unit
		Min.	Max.	Min.	Max.	Min.	Max.	
Read cycle time	t _{RC}	20	—	25	—	30	—	ns
Address access time	t _{AA}	—	20	—	25	—	30	ns
Chip enable access time ($\overline{CE1}$)	t _{CO1}	—	20	—	25	—	30	ns
Chip enable access time (CE2)	t _{CO2}	—	20	—	25	—	30	ns
Output enable to output valid	t _{OE}	—	10	—	12	—	12	ns
Output hold from address change	t _{OH}	5	—	5	—	5	—	ns
Chip enable to output in low Z ($\overline{CE1}$, CE2)	t _{LLZ1*} , t _{LLZ2*}	5	—	5	—	5	—	ns
Output enable to output in low Z (\overline{OE})	t _{OLZ*}	0	—	0	—	0	—	ns
Chip disable to output in high Z ($\overline{CE1}$, CE2)	t _{HZ1*} , t _{HZ2*}	0	10	0	12	0	12	ns
Chip disable to output in high Z (\overline{OE})	t _{OHZ*}	0	8	0	10	0	10	ns
Chip enable to power up time ($\overline{CE1}$, CE2)	t _{PU}	0	—	0	—	0	—	ns
Chip disable to power down time ($\overline{CE1}$, CE2)	t _{PD}	—	20	—	20	—	20	ns

2) Write cycle

Item	Symbol	- 20		- 25		- 30		Unit
		Min.	Max.	Min.	Max.	Min.	Max.	
Write cycle time	t _{WC}	20	—	25	—	30	—	ns
Address valid to end of write	t _{AW}	15	—	20	—	20	—	ns
Chip enable to end of write	t _{CW}	15	—	20	—	20	—	ns
Data to write time overlap	t _{DW}	10	—	12	—	12	—	ns
Data hold from write time	t _{DH}	0	—	0	—	0	—	ns
Write pulse width	t _{WP}	15	—	20	—	20	—	ns
Address set up time	t _{AS}	0	—	0	—	0	—	ns
Write recovery time (\overline{WE})	t _{WR}	0	—	0	—	0	—	ns
Write recovery time ($\overline{CE1}$, CE2)	t _{WR1}	0	—	0	—	0	—	ns
Output active from end of write	t _{OW*}	5	—	5	—	5	—	ns
Write to output in high Z	t _{WHZ*}	0	10	0	12	0	12	ns

* Transition is measured $\pm 500\text{mV}$ from steady voltage with specified loading in Fig. 1-(2).
This parameter is sampled and is not 100% tested.

5

Timing Waveform

1) Read cycle

- Read cycle (1) : $\overline{CE1} = \overline{OE} = V_{IL}$, $CE2 = V_{IH}$, $\overline{WE} = V_{IH}$

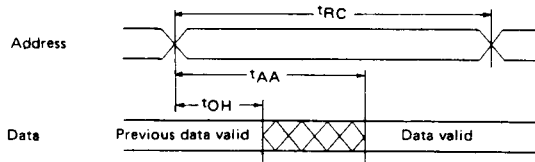

- Read cycle (2) : $\overline{WE} = V_{IH}$

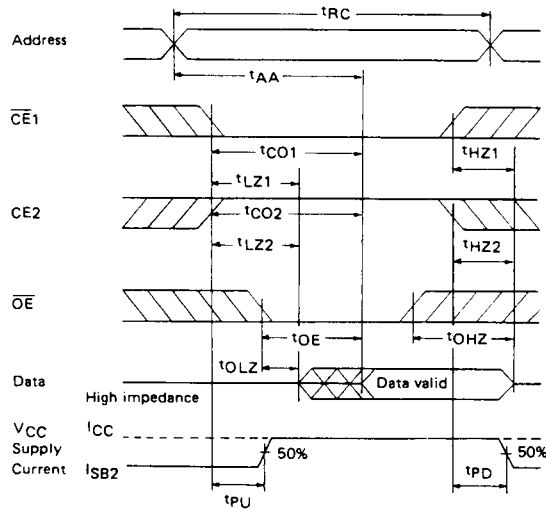

2) Write cycle

- Write cycle (1) : \overline{WE} control

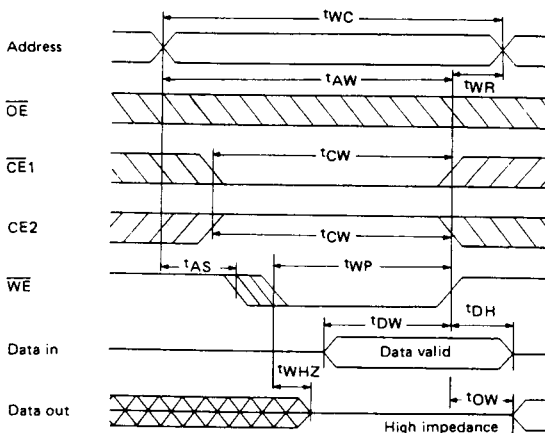

• Write cycle (2) : $\overline{CE1}$ control

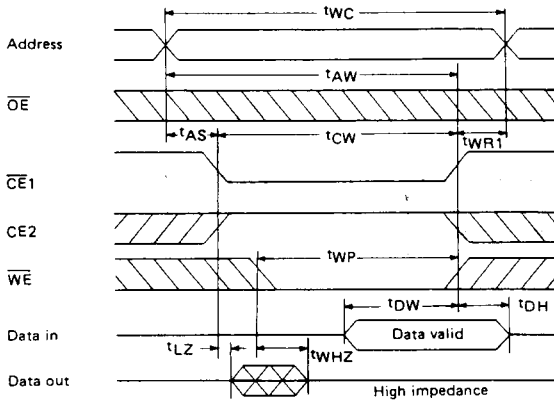

• Write cycle (3) : $\overline{CE2}$ control

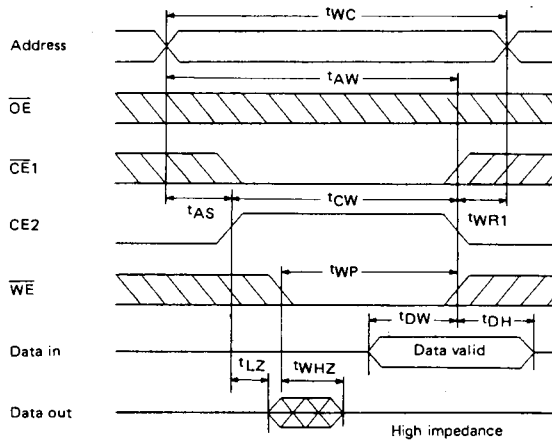

During I/O pins are in the output state, the data input signals of opposite phase to the output must not be applied.

Package Outline Unit : mm

CXK5863AP 28pin DIP (Plastic) 300mil 2.0g

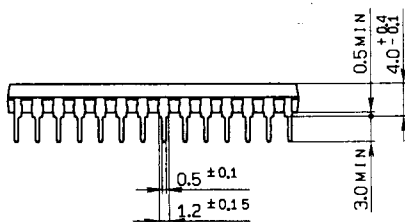
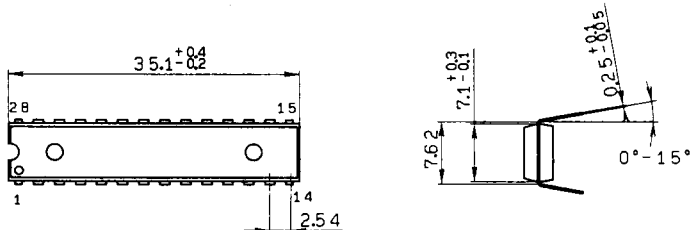

SONY NAME	DIP-28P-06
EIAJ NAME	*DIP028-P-0300-A
JEDEC CODE	MO-058-AB*

*(Similar)

CXK5863AJ 28pin SOJ (Plastic) 300mil 0.8g

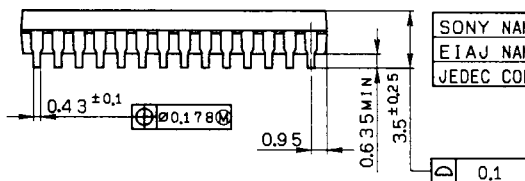
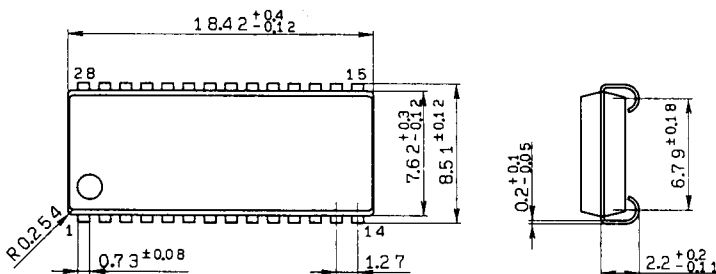

SONY NAME	SOJ-28P-01
EIAJ NAME	*SOJ028-P-0300-A
JEDEC CODE	MO-077-AB

D 0.1