

- Creepage distance of 8.0 mm (0.31 in) min. between coil and contact
- Dual-winding latching type available
- Plug-in and quick-connect terminals available
- High sensitivity (360 mW) and high capacity (16 A) types available
- Highly stable magnetic circuit for latching endurance and excellent resistance to vibration and shock
- Continuous coil rating
- Safety-oriented design assuring high surge resistance: 10,000 V min. between coil and contacts

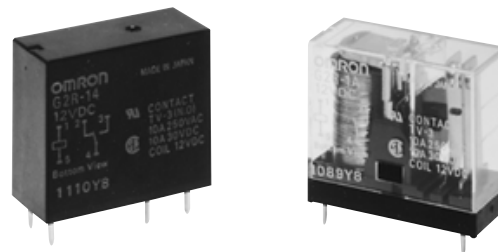

Ordering Information

To Order: Select the part number and add the desired coil voltage rating (e.g., G2R-14-DC12).

■ NON-LATCHING

1-Pole – PCB types

Type	Contact material	Contact form	Construction	Part number
General purpose	AgCdO	SPDT	Semi-sealed	G2R-1
			Sealed	G2R-14
		SPST-NO	Semi-sealed	G2R-1A
			Sealed	G2R-1A4
High capacity	AgCdO	SPDT	Semi-sealed	G2R-1-E
			SPST-NO	G2R-1A-E
High sensitivity	AgCdO	SPDT	Semi-sealed	G2R-1-H
			Sealed	G2R-14-H
		SPST-NO	Semi-sealed	G2R-1A-H
			Sealed	G2R-1A4-H

1-Pole – Plug-in/Quick-connect types

Type	Contact material	Contact form	Terminal	Part number
General purpose	AgCdO	SPDT	Plug-in	G2R-1-S
LED indicator				G2R-1-SN
Surge suppression diode				G2R-1-SD
LED indicator and surge suppression diode				G2R-1-SND
Upper-mount Bracket	AgCdO	SPDT	Quick Connect	G2R-1-T
		SPST-NO		G2R-1A-T

- Note:
1. AgInSn and gold plated contacts available.
 2. Bifurcated button available.
 3. For individual product agency approvals consult factory.
 4. Class B coil insulation available.

■ NON-LATCHING (continued)

2-Pole – PCB types

Type	Contact material	Contact form	Construction	Part number
General Purpose	AgCdO	DPDT	Semi-sealed	G2R-2
			Sealed	G2R-24
		DPST-NO	Semi-sealed	G2R-2A
			Sealed	G2R-2A4
High Sensitivity	AgCdO	DPDT	Semi-sealed	G2R-2-H
			Sealed	G2R-24-H
		DPST-NO	Semi-sealed	G2R-2A-H
			Sealed	G2R-2A4-H

2-Pole – Plug-in/Quick-connect types

Type	Contact material	Contact form	Terminal	Part number
General purpose	AgCdO	DPDT	Plug-in	G2R-2-S
LED indicator				G2R-2-SN
Surge suppression diode				G2R-2-SD
LED indicator and surge suppression diode				G2R-2-SND

- Note: 1. AgInSn and gold plated contacts available.
 2. Bifurcated button available.
 3. For individual product agency approvals consult factory.
 4. Class B coil insulation available.

■ LATCHING

Type	Contact form	Construction	Part number
Dual coil latching	SPDT	Semi-sealed	G2RK-1
	SPST-NO		G2RK-1A
	DPDT		G2RK-2
	DPST-NO		G2RK-2A

■ ACCESSORIES

Track mounted sockets/tracks

Relay	Part number	
	Socket	Mounting track
G2R-1-S□□ (1-pole)	P2RF-05-E	PPF-100N or
G2R-2-S□□ (2-pole)	P2RF-08-E	PPF-50N and PPF-M end plate PPF-S (optional spacer)

Back connecting sockets/plate

Relay	Terminal	Part number	
		Socket	Socket mounting plate
G2R-1-S□□ (1-pole)	Solder	P2R-05A	P2R-P
	PC	P2R-05P	
G2R-2-S□□ (2-pole)	Solder	P2R-08A	
	PC	P2R-08P	

Specifications

■ CONTACT DATA

Non-latching general purpose, plug-in, plug-in operation indicator self-contained, plug-in diode self-contained, and upper-mount bracket

Load	1-pole type		2-pole type	
	Resistive load (p.f. = 1)	Inductive load (p.f. = 0.4) (L/R = 7 ms)	Resistive load (p.f. = 1)	Inductive load (p.f. = 0.4) (L/R = 7 ms)
Rated load	10 A at 250 VAC 10 A at 30 VDC	7.5 A at 250 VAC 5 A at 30 VDC	5 A at 250 VAC 5 A at 30 VDC	2 A at 250 VAC 3 A at 30 VDC
Contact material	AgCdO			
Carry current	10 A		5 A	
Max. operating voltage	380 VAC, 125 VDC			
Max. operating current	10 A		5 A	
Max. switching capacity	2,500 VA, 300 W	1,875 VA, 150 W	1,250 VA, 150 W	500 VA, 90 W
Min. permissible load	100 mA, 5 VDC		10 mA, 5 VDC	

Non-latching high capacity 1-pole type

Load	Resistive load (p.f. = 1)	Inductive load (p.f. = 0.4) (L/R = 7 ms)
Rated load	16 A at 250 VAC 16 A at 30 VDC	8 A at 250 VAC 8 A at 30 VDC
Contact material	AgCdO	
Carry current	16 A	
Max. operating voltage	380 VAC, 125 VDC	
Max. operating current	16 A	
Max. switching capacity	4,000 VA, 480 W	2,000 VA, 240 W
Min. permissible load	100 mA, 5 VDC	

Non-latching high-sensitivity

Load	1-pole type		2-pole type	
	Resistive load (p.f. = 1)	Inductive load (p.f. = 0.4) (L/R = 7 ms)	Resistive load (p.f. = 1)	Inductive load (p.f. = 0.4) (L/R = 7 ms)
Rated load	5 A at 250 VAC 5 A at 30 VDC	2 A at 250 VAC 3 A at 30 VDC	3 A at 250 VAC 3 A at 30 VDC	1 A at 250 VAC 1.50 A at 30 VDC
Contact material	AgCdO			
Carry current	5 A		3 A	
Max. operating voltage	380 VAC, 125 VDC			
Max. operating current	5 A		3 A	
Max. switching capacity	1,250 VA, 150 W	500 VA, 90 W	750 VA, 90 W	250 VA, 45 W
Min. permissible load	100 mA, 5 VDC		10 mA, 5 VDC	

Latching

Load	1-pole type		2-pole type	
	Resistive load (p.f. = 1)	Inductive load (p.f. = 0.4) (L/R = 7 ms)	Resistive load (p.f. = 1)	Inductive load (p.f. = 0.4) (L/R = 7 ms)
Rated load	5 A at 250 VAC 5 A at 30 VDC	3.50 A at 250 VAC 2.50 A at 30 VDC	3 A at 250 VAC 3 A at 30 VDC	1.50 A at 250 VAC 2 A at 30 VDC
Contact material	AgCdO			
Carry current	5 A		3 A	
Max. operating voltage	380 VAC, 125 VDC			
Max. operating current	5 A		3 A	
Max. switching capacity	1,250 VA, 150 W	875 VA, 75 W	750 VA, 90 W	375 VA, 60 W
Min. permissible load	100 mA, 5 VDC		10 mA, 5 VDC	

- Note: 1. P standard: $\lambda_{50} = 0.10 \times 10^{-6}$ operation.
 2. AgInSn contacts available.
 3. For individual product agency approvals consult factory.

■ COIL DATA

Non-latching DC coil

Rated voltage (VDC)	Rated current (mA)	Coil resistance (Ω)	Coil inductance (ref. value) (H)		Pick-up voltage % of rated voltage	Dropout voltage	Maximum voltage at 70°C (158°F)	Power consumption (mW)
			Armature OFF	Armature ON				
3	176	17	0.07	0.14	70% max.	15% min.	110% max. at 70°C (158°F)	Approx. 530
5	106	47	0.20	0.39				
6	88.20	68	0.28	0.55				
12	43.60	275	1.15	2.29				
24	21.80	1,100	4.27	8.55				
48	11.50	4,170	13.86	22.71				
100	5.30	18,860	67.20	93.20				
110	4.80	22,900	81.50	110.60				

Non-latching AC coil

Rated voltage (VDC)	Rated current (mA)	Coil resistance (Ω)	Coil inductance (ref. value) (H)		Pick-up voltage % of rated voltage	Dropout voltage	Maximum voltage at 70°C (158°F)	Power consumption (mW)
			Armature OFF	Armature ON				
6	150	16	0.05	0.10	80% max.	30% min.	110% max. at 70°C (158°F)	Approx. 0.9
12	75	65	0.19	0.39				
24	37.50	260	0.81	1.55				
50	18	1,130	3.25	6.73				
110	10.60	4,600	13.34	26.84				
120	7.50	6,500	21	42				
220	5.30	22,000	51.30	102				
240	3.80	30,000	65.50	131				

Non-latching high-sensitivity DC coil

Rated voltage (VDC)	Rated current (mA)	Coil resistance (Ω)	Coil inductance (ref. value) (H)		Pick-up voltage % of rated voltage	Dropout voltage	Maximum voltage at 70°C (158°F)	Power consumption (mW)
			Armature OFF	Armature ON				
3	120	25	0.13	0.26	70% max.	15% min.	110% max. at 70°C (158°F)	Approx. 360
5	71.40	70	0.37	0.75				
6	60	100	0.53	1.07				
12	30	400	2.14	4.27				
24	15	1,600	7.80	15.60				
48	7.50	6,400	31.20	62.40				

■ COIL DATA (continued)

Latching dual coil type - Set coil

Rated voltage (VDC)	Rated current (mA)	Coil resistance (Ω)	Coil inductance (ref. value) (H)		Set pick-up voltage % of rated voltage	Reset dropout voltage	Maximum voltage at 70°C (158°F)	Power consumption (mW)
			Armature OFF	Armature ON				
3	227	10.80	0.026	0.052	70% max.	70% max.	110% max. at 70°C (158°F)	Approx. 850
5	167	30	0.073	0.146				
6	138	43.50	0.104	0.208				
12	70.60	170	0.42	0.83				
24	34.60	694	1.74	3.43				

Latching dual coil type - Reset coil

Rated voltage (VDC)	Rated current (mA)	Coil resistance (Ω)	Coil inductance (ref. value) (H)		Set pick-up voltage % of rated voltage	Reset dropout voltage	Maximum voltage at 70°C (158°F)	Power consumption (mW)
			Armature OFF	Armature ON				
3	200	15	0.001	0.002	70% max.	70% max.	110% max. at 70°C (158°F)	Approx. 600
5	119	42	0.003	0.006				
6	100	60	0.005	0.009				
12	50	240	0.018	0.036				
24	25	960	0.079	0.148				

- Note: 1. The rated current and coil resistance are measured at a coil temperature of 23°C (73°F) with a tolerance of $\pm 10\%$.
2. The operating characteristics are measured at a coil temperature of 23°C (73°F).

■ CHARACTERISTICS

		Non-latching	Latching
Contact resistance		one-pole: 30 m Ω max.; 2-pole: 50 m Ω max.	
Operate (set) time		15 ms max.	20 ms max.
Release (reset) time		AC: 10 ms max.; DC: 5 ms max.	20 ms max.
Bounce time	Operate	—	Mean value approx. 3 ms
	Release	—	Mean value approx. 8 ms
Operating frequency	Mechanical	18,000 operations/hour	
	Electrical	1,800 operations/hour (under rated load)	
Insulation resistance		1,000 M Ω min. (at 500 VDC)	
Dielectric strength		5,000 VAC, 50/60 Hz for 1 minute between coil and contacts	
		1,000 VAC, 50/60 Hz for 1 minute across contacts of same pole	
		3,000 VAC, 50/60 Hz for 1 minute between contact sets, 2-pole non-latching	
		1,000 VAC, 50/60 Hz for 1 minute between set and reset coils of dual coil latching	
Vibration	Mechanical durability	10 to 55 Hz; 1.50 mm (0.06 in) double amplitude	
	Malfunction durability	10 to 55 Hz; 1.50 mm (0.06 in) double amplitude	
Shock	Mechanical durability	1,000 m/s ² (approx. 100 G)	
	Malfunction durability	200 m/s ² (approx. 20 G) when energized 100 m/s ² (approx. 10 G) when de-energized	500 m/s ² (approx. 50 G) at set 100 m/s ² (approx. 10 G) at reset
Ambient temperature		-40 to 70°C (-40° to 158°F)	
Humidity		35% to 85% RH	
Service life	Mechanical	AC: 10,000,000 operations min. DC: 20,000,000 operations min. (at 18,000 operations/hour)	10,000,000 operations min. (at 18,000 operations/hour)
	Electrical	See "Characteristic Data"	
Weight		Approx. 17 g (0.60 oz)	Approx. 17 g (0.60 oz)

Note: Data shown are of initial value.

■ CHARACTERISTIC DATA

Maximum switching capacity — non-latching types

PCB: Single-pole general purpose
Semi-sealed
Plug-in: Single-pole single button
Quick-connect

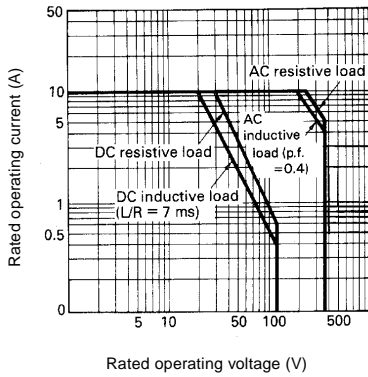

High capacity

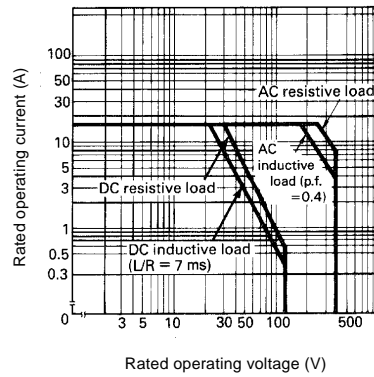

PCB: Single-pole high sensitivity
Two-pole general purpose
Plug-in: Two-pole single button

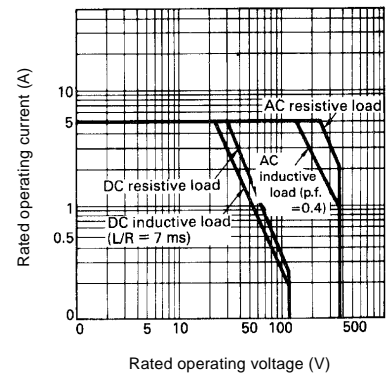

PCB: Two-pole high sensitivity

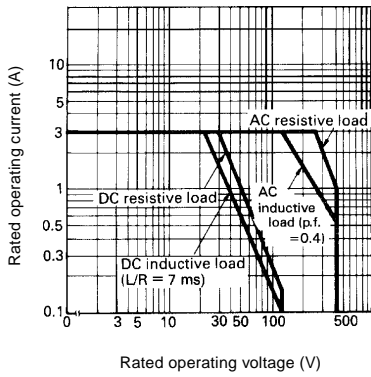

PCB: Single-pole general purpose
Sealed

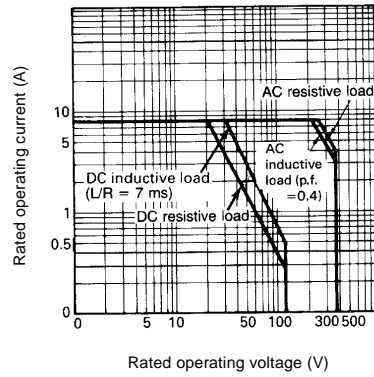

PCB: Two-pole general purpose
Sealed

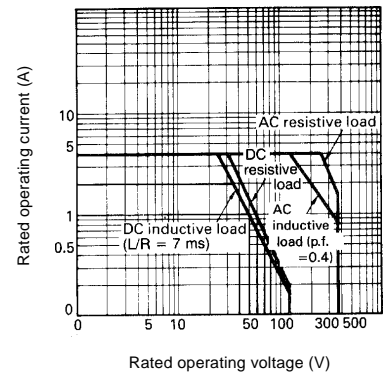

Electrical service life — non-latching types

PCB: Single-pole general purpose
Semi-sealed
Plug-in: Single-pole single button
Quick connect

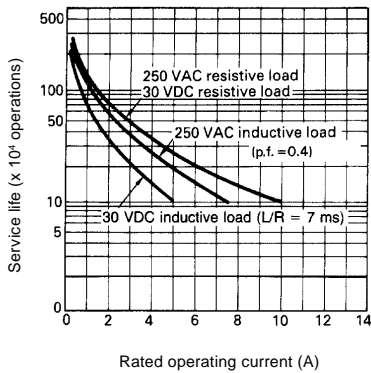

High capacity

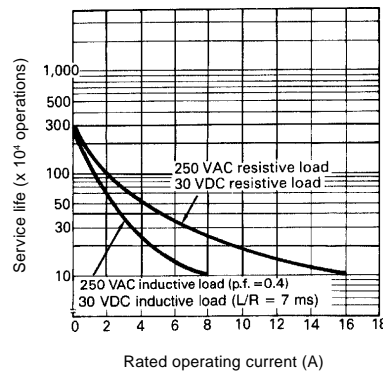

PCB: Single-pole high sensitivity
Two-pole general purpose
Plug-in: Two-pole single button

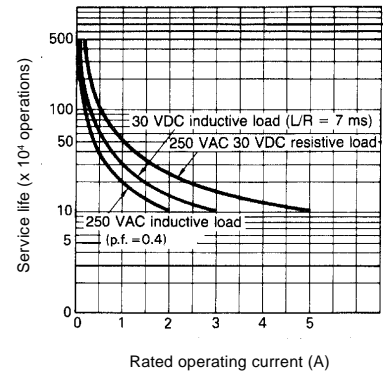

PCB: Two-pole high sensitivity

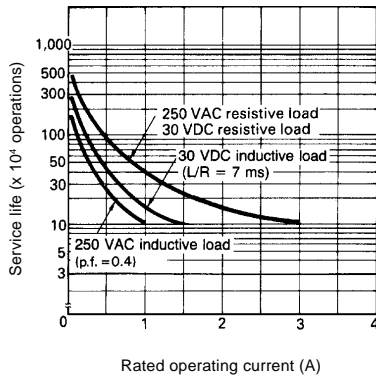

PCB: Single-pole general purpose Sealed

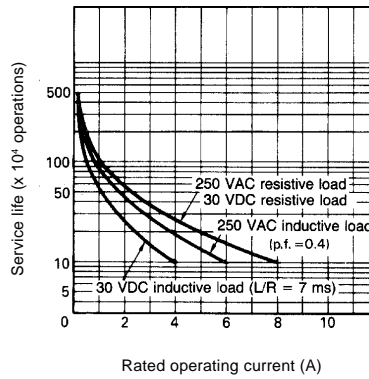

PCB: Two-pole general purpose Sealed

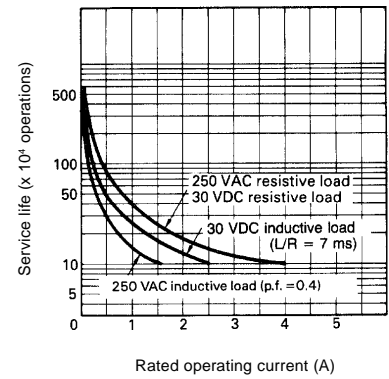

Maximum switching capacity — latching types

One-pole

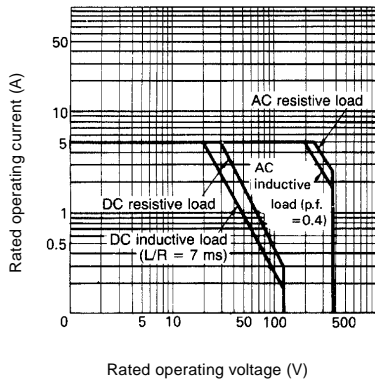

Two-pole

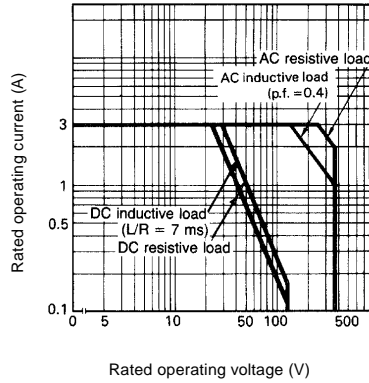

Electrical service life — latching types

One-pole

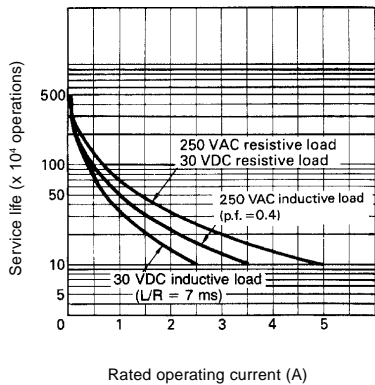

Two-pole

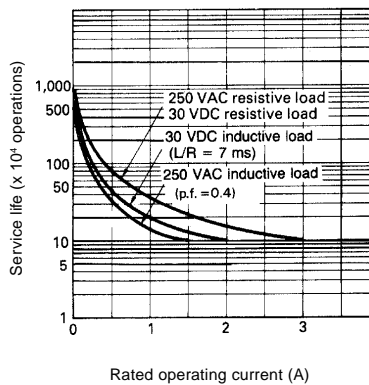

Dimensions

Unit: mm (inch)

■ NON-LATCHING

PCB Terminal: SPDT, general purpose & high sensitivity

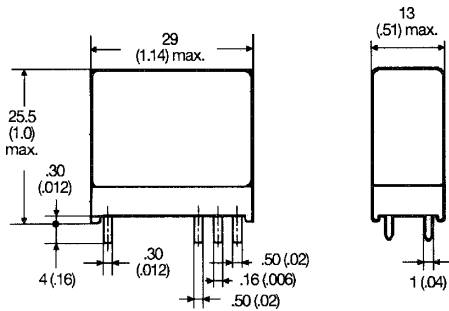

Terminal arrangement/
Internal connections
(Bottom view)

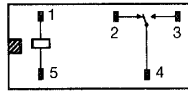

Mounting holes
(Bottom view)

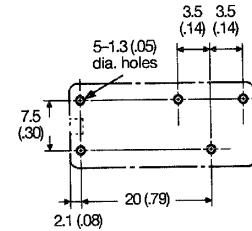

PCB Terminal: SPST-NO, general purpose & high sensitivity

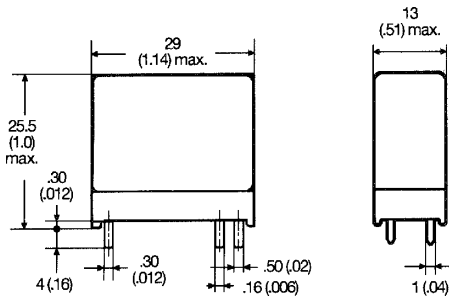

Terminal arrangement/
Internal connections
(Bottom view)

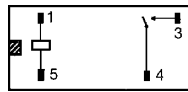

Mounting holes
(Bottom view)

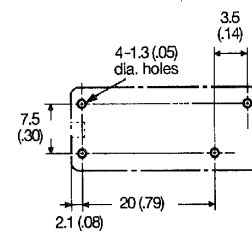

PCB Terminal: SPDT, high capacity

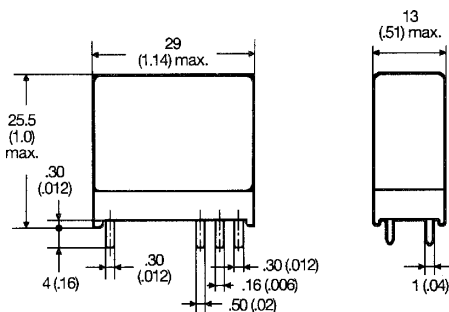

Terminal arrangement/
Internal connections
(Bottom view)



Mounting holes
(Bottom view)

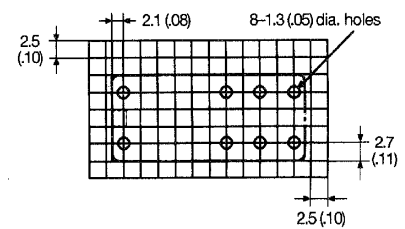

PCB Terminal: SPST-NO, high capacity

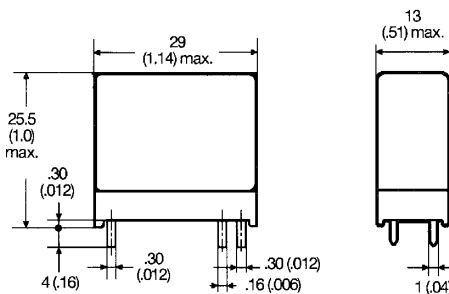

Terminal arrangement/
Internal connections
(Bottom view)

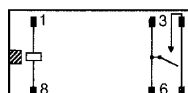

Mounting holes
(Bottom view)

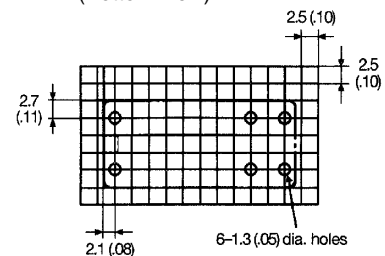

- Note: 1. and indicate mounting orientation marks.
2. A tolerance of ± 0.10 (0.004) applies to the above dimensions.

Plug-in: SPDT, single button general purpose, LED indicator, surge suppression diode

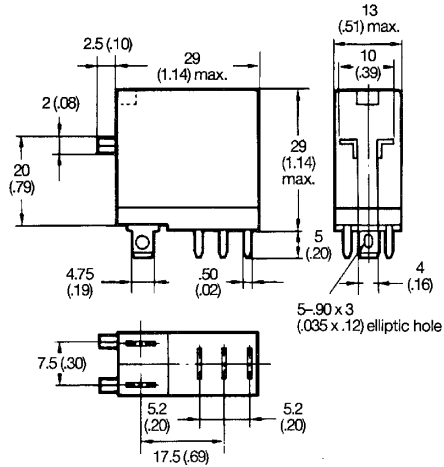

Terminal arrangement/Internal connections
(Bottom view)

G2R-1-S

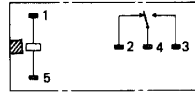

G2R-1-SN(AC)

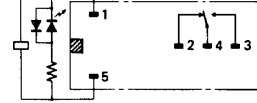

G2R-1-SND(DC)

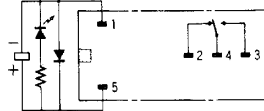

G2R-1-SN(DC)

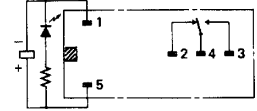

G2R-1-SD(DC)

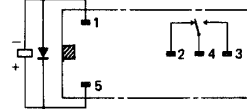

Quick-connect: SPDT

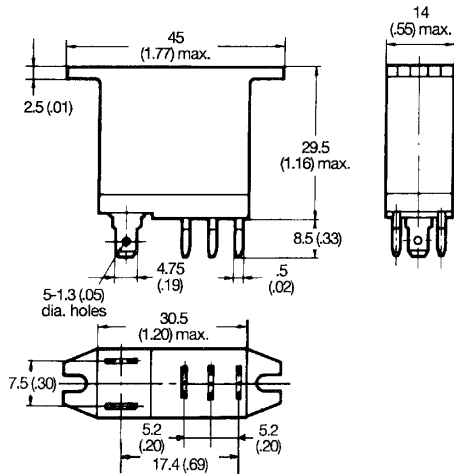

Terminal arrangement/
Internal connections
(Bottom view)

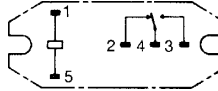

Mounting holes
(Bottom view)

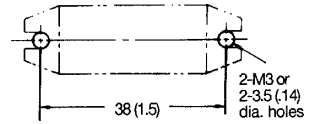

PCB Terminal: SPST-NO, high capacity

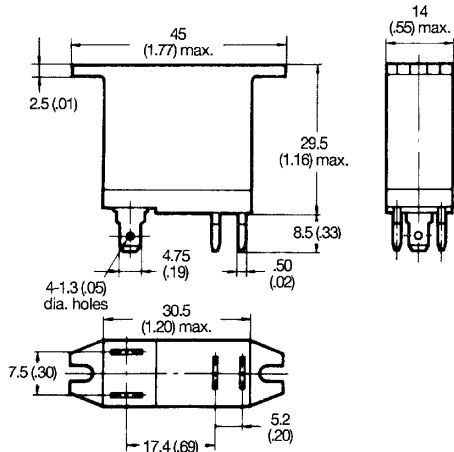

Terminal arrangement/
Internal connections
(Bottom view)

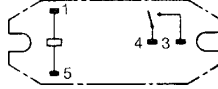

Mounting holes
(Bottom view)

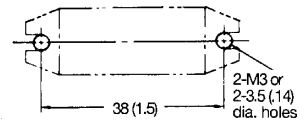

Note: 1. and indicate mounting orientation marks.
2. A tolerance of ± 0.10 (0.004) applies to the above dimensions.

Unit: mm (inch)

PCB Terminal: DPDT, general purpose & high sensitivity

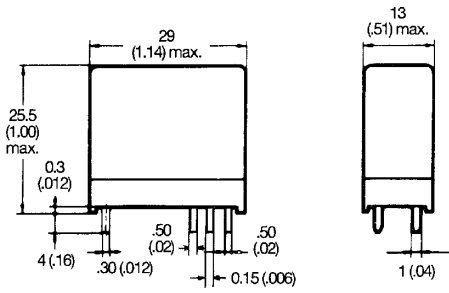

**Terminal arrangement/
Internal connections
(Bottom view)**

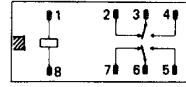

**Mounting holes
(Bottom view)**

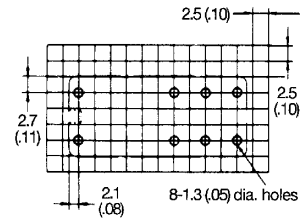

PCB Terminal: DPST-NO, general purpose & high sensitivity

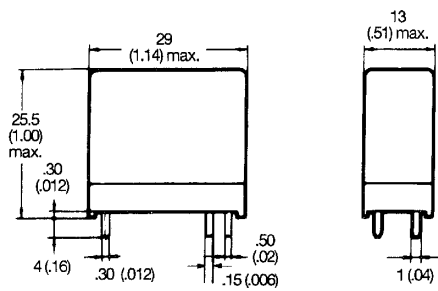

**Terminal arrangement/
Internal connections
(Bottom view)**

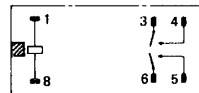

**Mounting holes
(Bottom view)**

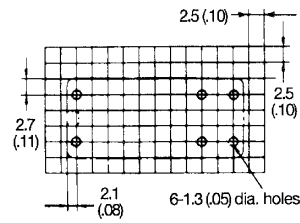

Plug-in: DPDT

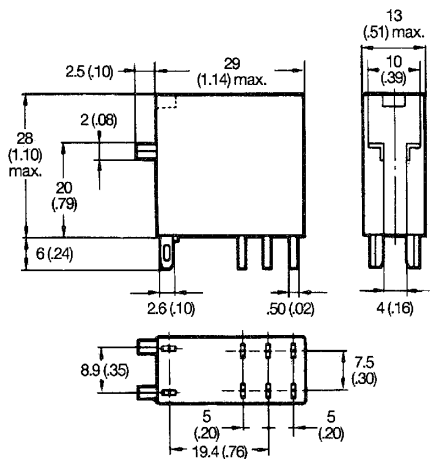

**Terminal arrangement/Internal connections
(Bottom view)**

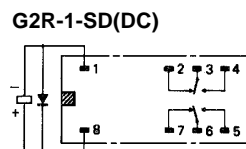
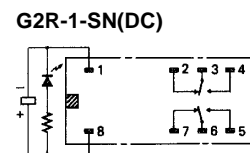
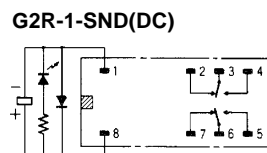
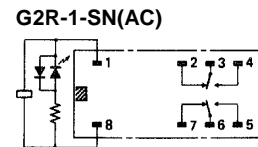
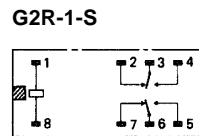

Note: 1. and indicate mounting orientation marks.
2. A tolerance of ± 0.10 (0.004) applies to the above dimensions.

■ LATCHING

SPDT, Dual coil latching
G2RK-1

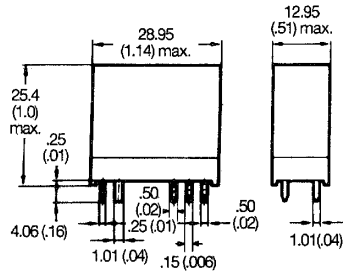

Dual coil

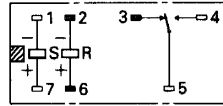

Dual coil

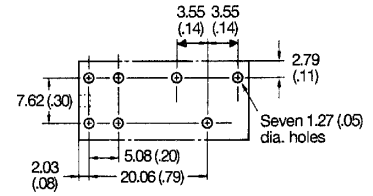

SPST-NO, Dual coil latching
G2RK-1A

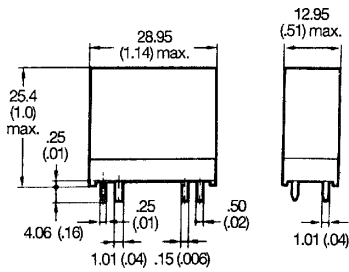

Dual coil

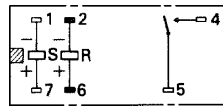

Dual coil

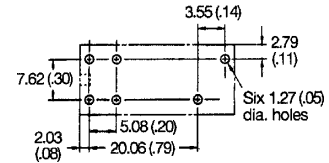

DPDT, Dual coil latching
G2RK-2

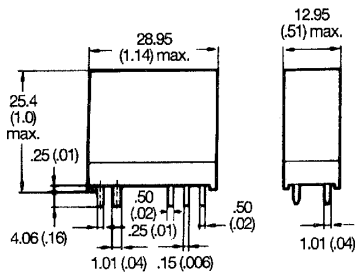

Dual coil

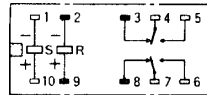

Dual coil

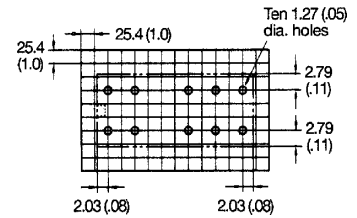

DPST-NO, Dual coil latching
G2RK-2A

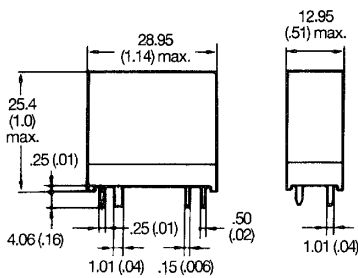

Dual coil

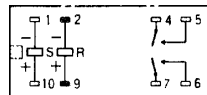

Dual coil

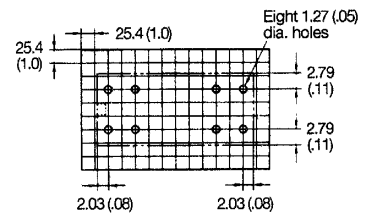

Note: 1. and indicate mounting orientation marks.
2. A tolerance of ± 0.10 (0.004) applies to the above dimensions.

Unit: mm (inch)

■ ACCESSORIES

Track mounted socket
P2RF-05-E (UL E87929/CSA LR31928)

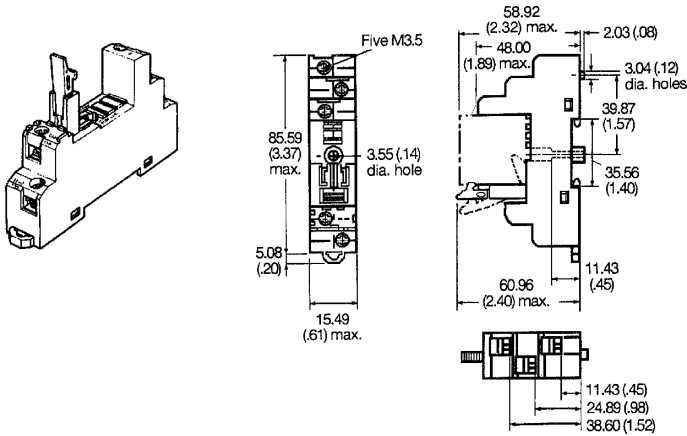

Terminal arrangement

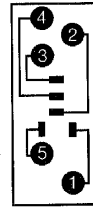

Mounting holes

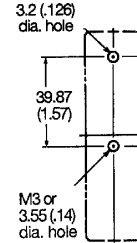

Track mounted socket
P2RF-08-E (UL E87929/CSA LR31928)

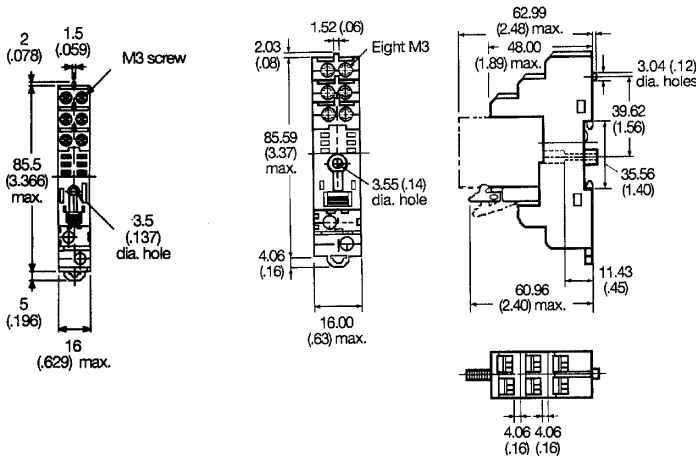

Terminal arrangement

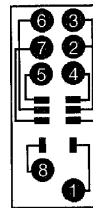

Mounting holes

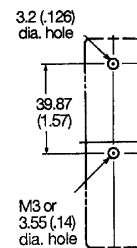

Back connecting socket
P2R-05P (1-pole) (UL E87929/CSA LR31928)

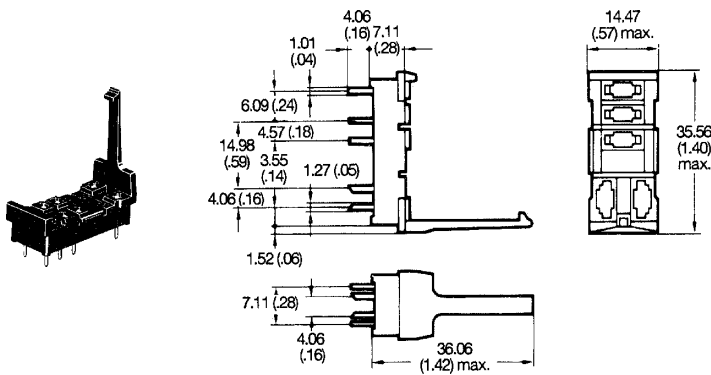

Terminal arrangement

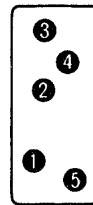

Mounting holes

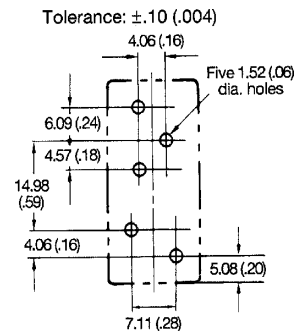

Note: 1. and indicate mounting orientation marks.
 2. A tolerance of ±0.10 (0.004) applies to the above dimensions.

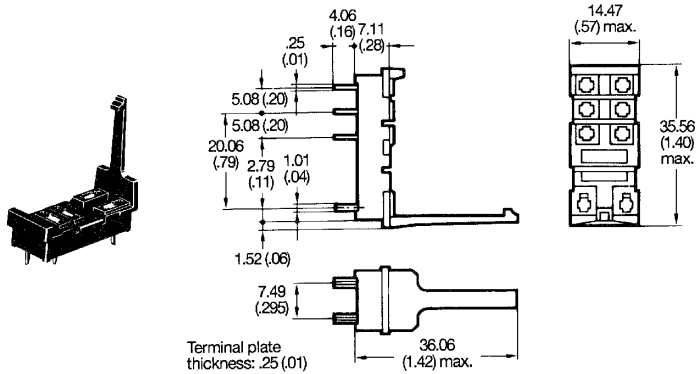
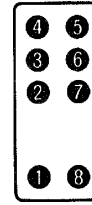
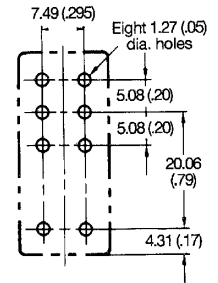
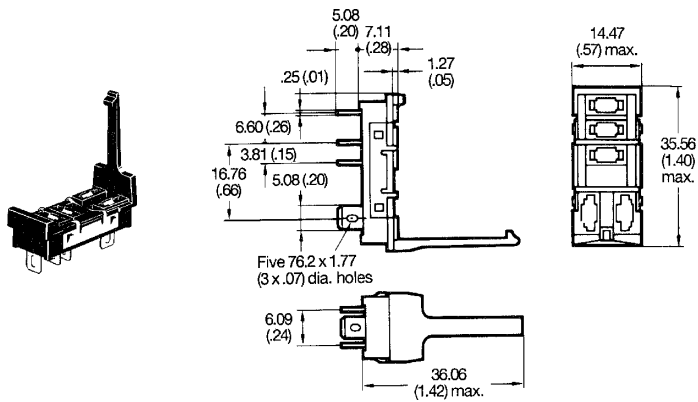
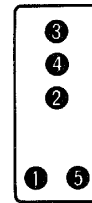
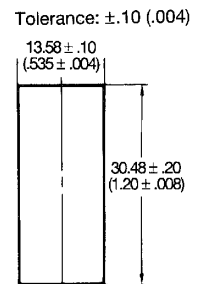
Back connecting socket**P2R-08P (2-pole) (UL E87929/CSA LR31928)****Terminal arrangement****Mounting holes****Back connecting socket****P2R-05A (1-pole) (UL E87929/CSA LR31928)****Terminal arrangement****Mounting holes
(Bottom view)**

Recommended thickness of the panel is 1.52 (.06) to 2.03 (.08)

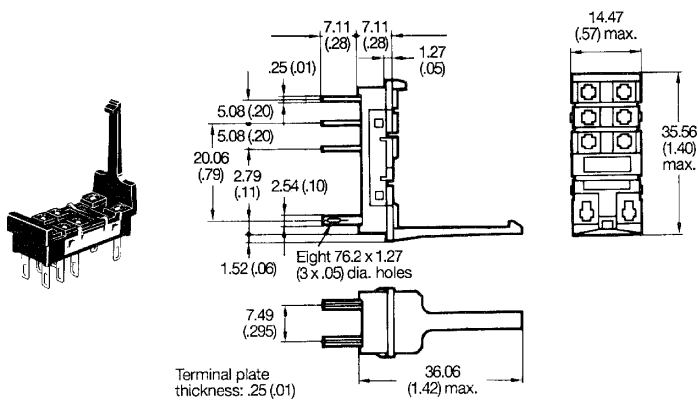
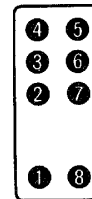
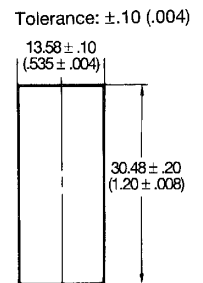
Back connecting socket**P2R-08A (2-pole) (UL E87929/CSA LR31928)****Terminal arrangement****Mounting holes
(Bottom view)**

Recommended thickness of the panel is 1.52 (.06) to 2.03 (.08)

- Note: 1. and indicate mounting orientation marks.
2. A tolerance of ±0.10 (0.004) applies to the above dimensions.

Unit: mm (inch)

**Mounting track
PFP-100N, PFP-50N**

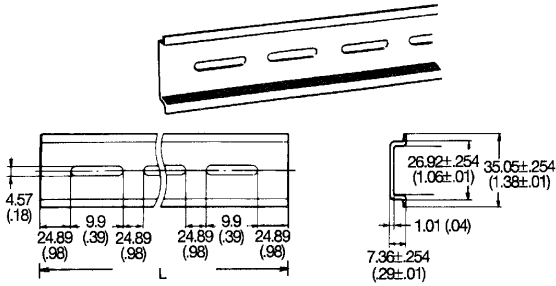

**Mounting track
PFP-100N2**

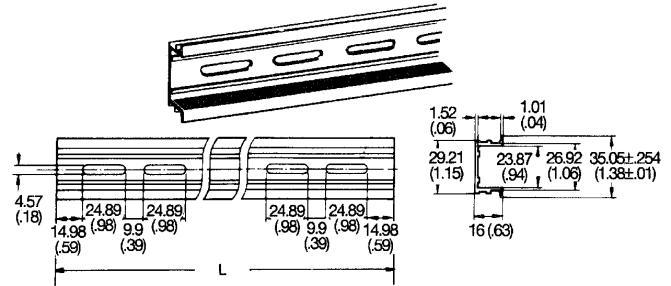

- Note: 1. It is recommended that a panel thickness of 0.06 to 0.08 mm (0.002 to 0.003 in) be used.
 2. L = Length
 PFP-100N L = 990.60 mm (39.00 in)
 PFP-50N L = 497.84 mm (19.60 in)
 PFP-100N2 L = 990.60 mm (39.00 in)

**End plate
PFP-M**

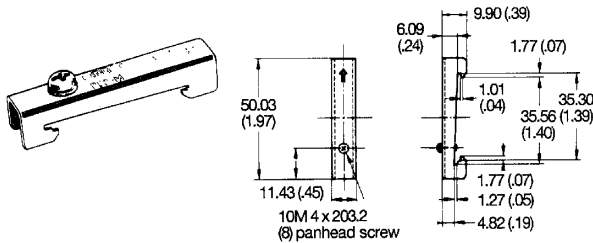

**Spacer
PFP-S**

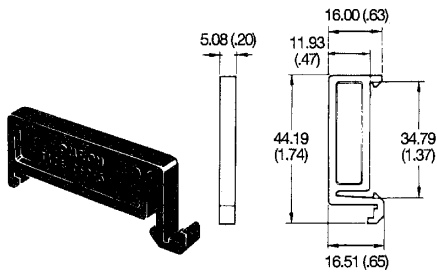

**Connecting socket mounting plate
P2R-P**

Used to mount several connecting sockets side by side.

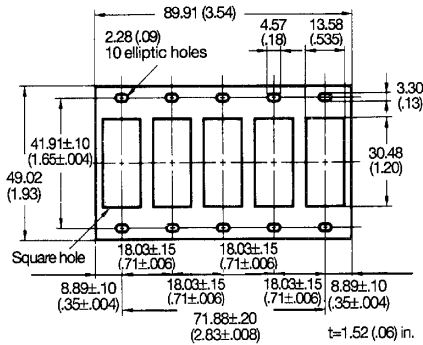

■ APPROVALS

UL (File No. E41643)/ CSA (File No. LR31928)

Type	Contact form	Coil rating	Contact ratings
G2R-1 G2R-14 G2R-1-H G2R-14-H G2R-1-S G2R-1-T	SPDT	3 to 110 VDC 3 to 240 VAC	10 A, 30 VDC (Resistive) 10 A, 250 VAC (General purpose) 10 A, 277 VAC (General purpose) TV-3, 120 VAC (NO contact) 360 WT, 120 VAC (Tungsten) 1/3 HP, 125 VAC 1/2 HP, 250 VAC 1/2 HP, 277 VAC TV-8, 120 VAC (NO contact, ASI contacts)
G2R-1A G2R-1A4 G2R-1A-H G2R-1A4-H G2R-1A-T	SPST-NO		
G2R-1-E	SPDT	3 to 110 VDC 3 to 240 VAC	20 A, 277 VAC (General purpose) 16 A, 30 VDC (Resistive) 16 A, 250 VAC (General purpose) 360 WT, 120 VAC (Tungsten) TV-3, 120 VAC (NO contact) 1/2 HP, 240 VAC 1 HP, 240 VAC (Pilot duty) TV-8, 120 VAC (NO contact, ASI contacts)
G2R-1A-E	SPST-NO		
G2R-2 G2R-24 G2R-2- H G2R-24-H G2R-2-S G2R-2-A G2R-2A4 G2R-2A-H G2R-2A4-H	DPDT	3 to 110 VDC 3 to 240 VAC	10 A, 30 VDC (Resistive) 10 A, 277 VAC (General purpose) 5 A, 250 VAC (General purpose) TV-3, 120 VAC (NO contact) 1/6 HP, 120 VAC 1/3 HP, 240 VAC 1/3 HP, 265 VAC 250 VA, 120 VAC (Pilot duty)
G2RK-1	SPDT	3 to 24 VDC	10 A, 30 VDC (Resistive)
G2RK-1A	SPST-NO		10 A, 250 VAC (General purpose) TV-3 (NO contact) 1/6 HP, 120 VAC 1/2 HP, 120 VAC A300 (Pilot duty)
G2RK-2	DPDT	3 to 24 VDC	5 A, 30 VDC (Resistive)
G2RK-2A	DPST-NO		5 A, 250 VAC (General purpose) TV-3 (NO contact) 1/6 HP, 120 VAC 1/3 HP, 240 VAC

- Note: 1. The rated values approved by each of the safety standards (e.g., UL and CSA) may be different from the performance characteristics individually defined in this catalog.
2. In the interest of product improvement, specifications are subject to change.

OMRON

OMRON ELECTRONICS, INC.

One East Commerce Drive
Schaumburg, IL 60173

1-800-55-OMRON

OMRON CANADA, INC.

885 Milner Avenue
Scarborough, Ontario M1B 5V8
416-286-6465