

PTC-10 10 mm Cermet Potentiometer

FEATURES

- Cermet resistive element.
- Dust proof enclosure.
- Plastic material according to UL94V-0
- Alumina substrate.
- Also upon request:
 - Wiper positioned at 50% or fully clockwise.
 - Supplied in magazines for automatic insertion.
 - Long life model for low cost control pot. applications
 - Special tapers
 - Mechanical detents
 - Low & extra low torque versions
 - Available as SPDT switch
 - Laser trimming for tighter tolerances

MECHANICAL SPECIFICATIONS

- Mechanical rotation angle: 235° ± 5°
- Electrical rotation angle: 220° ± 20°
- Torque: 0.4 to 2 Ncm. (0.6 to 2.7 in-oz)
- Stop torque: > 5 Ncm. (>7 in-oz)
- Life*: Up to 10.000 cycles

* Others upon request

ELECTRICAL SPECIFICATIONS

- Range of values (*)
100Ω ≤ Rn ≤ 5 M (Decad. 1.0 - 2.0 - 2.2 - 2.5 - 4.7 - 5.0)
 - Tolerance (*): 100Ω ≤ Rn ≤ 1M Ω ± 20%
1MΩ < Rn ≤ 5M Ω ± 30%
 - Max. Voltage: 200 VDC (lin) 100 VDC (no lin)
 - Nominal Power 70°C (158°F) (see power rating curve)
0.33 W (lin) 0.17 W (no lin)
 - Taper (*) (Log. & Alog. only Rn ≥ 1K) Lin ; Log; Alog.
 - Residual resistance(*): ≤ 5.10⁻³ Rn (5 Ω min.)
 - Equivalent Noise Resistance: ≤ 3% Rn (3 Ω min.)
 - Operating temperature: -40°C + 90°C (-40°F + 194°F)
- (*) Others upon request

HOW TO ORDER

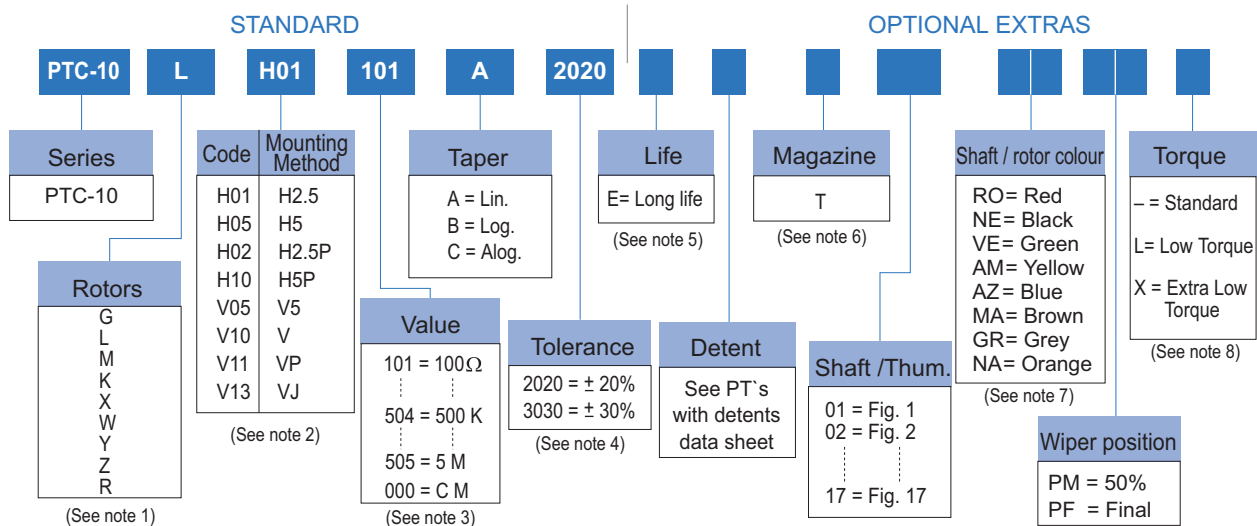

NOTES:

- (1) "Z" adjustment only available on "H" versions. Rotor "G" only available in purple (shaft/rotor colour "VI").
- (2) Terminal styles: "P" & "J" are crimped terminals. V=Vertical adjust; H=Horizontal Adjust
- (3) Value Example: Code: 10 1 = 100 Ω
 ↳ Num of zeros
 ↳ First two digits of the value. 000 = CM: SPDT switch 45°
- (4) Non standard tolerance, upon request. Example: +7% Code: 07 05
 ↳ -5% ↳ negative tolerance
 ↳ positive tolerance
- (5) Up to 10.000 cycles. Others upon request.
- (6) Magazines: not available with the H10, V05 and V13 models, nor with adjustment types X, W, Y, Z. Non flammable: housing, rotor and shaft.
- (7) Colour shaft/rotor: • Potentiometer without shaft: only rotor • Potentiometer with shaft: only shaft
- (8) Low Torque: 0.25 to 1 Ncm (per pot.)
 Extra Low Torque: 0.1 to 0.4 Ncm (per pot.). Only available on "H" models without crimping
 No detent option available for low and extra low torque models. No shaft or thumbwheel option for extra low torque models.

NOTE: The information contained here should be used for reference purposes only.

HOW TO ORDER CUSTOM DRAWING

STANDARD OPTIONS

PTC-10 LH 01 + DRAWING NUMBER (Max. 16 characters)

Detents	-----	None
Packing	-----	Bulk
Rotor colour	-----	Natural
Shaft colour	-----	Natural
Wiper position	-----	Initial
Torque	-----	Standard

This way of ordering should be used for options which are not included in the "How to order" standard and optional extras.

ROTORS

Without shaft

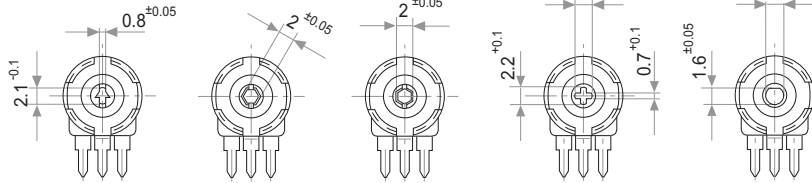

L = Screwdriver thru hole

M = Hexagonal thru hole

G = Hexagonal thru hole

K = Cross slot thru hole

R

With shaft

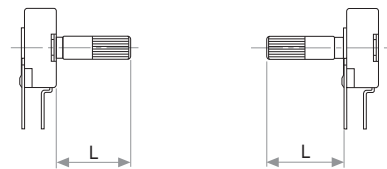

X = Adjustable from collector side

W = Adjustable from terminal side

Wipers positioned at 50%

With thumbwheel

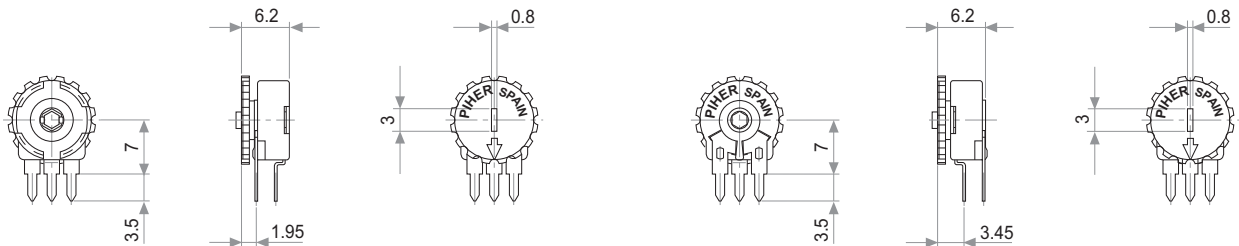

Y = Adjustable from terminal side

Z = Adjustable from collector side

MOUNTING METHODS

v = horizontal mount – vertical adjust

h = vertical mount – horizontal adjust

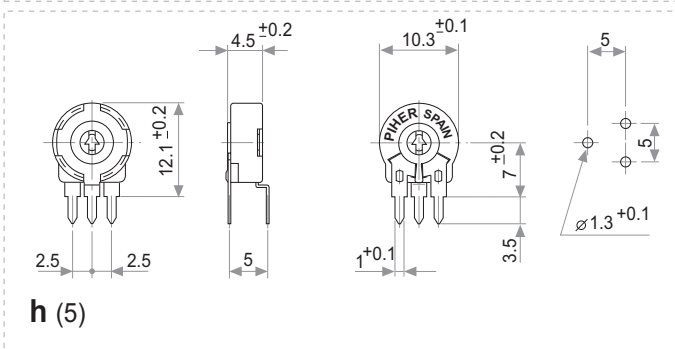
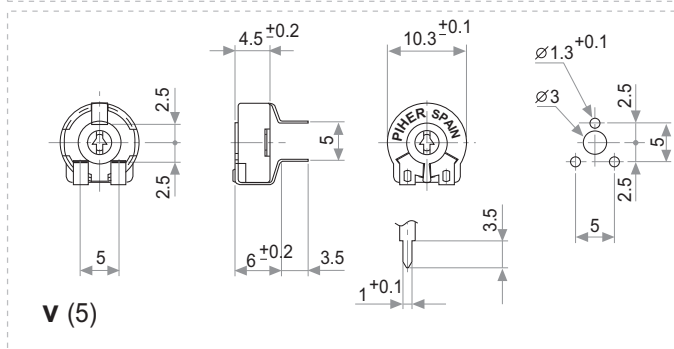
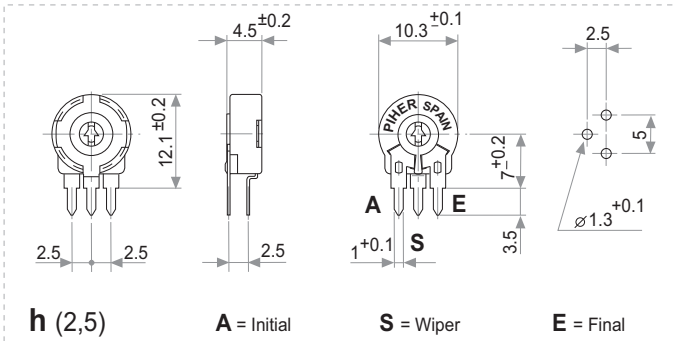
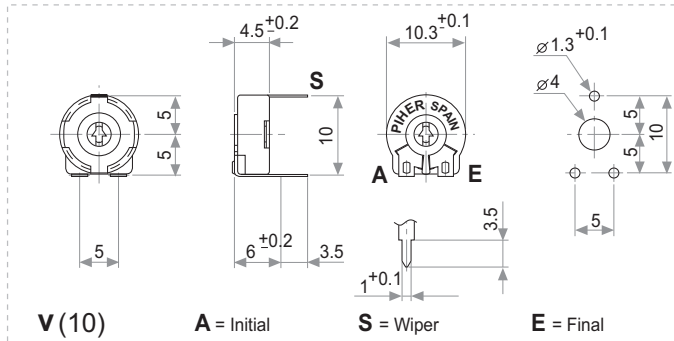

NOTE = Please note relative terminal positions when ordering non linear tapers.

Crimped terminals

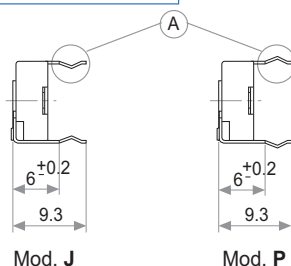

Mod. J

Mod. P

OPTIONS

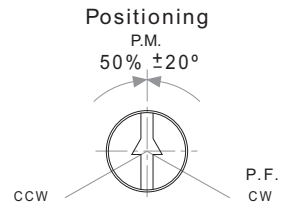
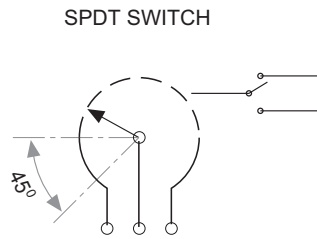

Std. Position = CCW

TAPERS

A = Linear
B = Log.
C = Alog.

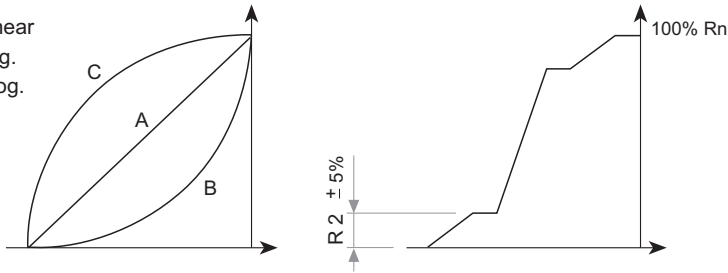

Standard

Special example

POWER RATING CURVE

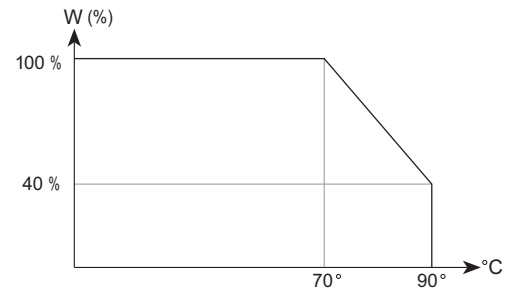

NOTE = Please note relative terminal positions when ordering non linear tapers.

TESTS

TYPICAL VARIATIONS

ELECTRICAL LIFE	1.000 h. @ 70°C; 0.33 W	±5 %
MECHANICAL LIFE (CYCLES)	100 @ 10 CPM ...15 CPM	±3 % (Rn < 1 MΩ)
TEMPERATURE COEFFICIENT	-40°C; +90°C	±100 ppm (Rn <100 ±K)
THERMAL CYCLING	16 h. @ 90°C; 2h. @ -40°C	±2.5 %
DAMP HEAT	500 h. @ 40°C @ 95% HR	±5 %
VIBRATION (for each plane X,Y,Z)	2 h. @ 10 Hz. ... 55 Hz.	2 %

NOTE: Out of range values may not comply these results.

PACKAGING

BOXES

Model	Units
Without shaft	500 (40 x 85 x 185 mm.)
With thumbwheel	400 (40 x 85 x 185 mm.)
With shaft	200 (40 x 85 x 185 mm.)

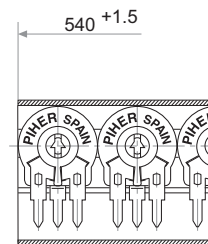
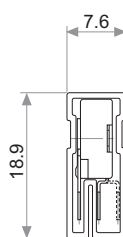

Magazines for PTC-10 h 2.5; h 5

Also crimped term. h 2.5 P

AUTOMATIC INSERTION

Magazines	Units
PTC-10H & PTC-10V	50 Pieces

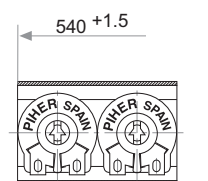
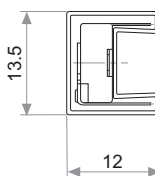

Magazines for PTC-10 V

Also crimped term. VP

SHAFTS

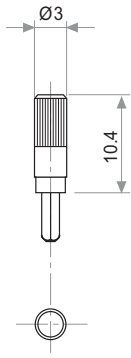

Fig. 1 / Ref. 5016

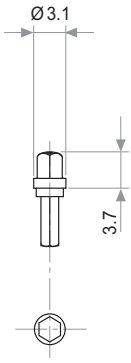

Fig. 2 / Ref. 5053

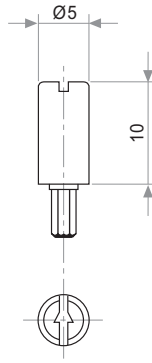

Fig. 3 / Ref. 5012

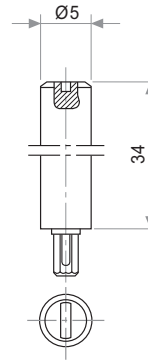

Fig. 4 / Ref. 6053

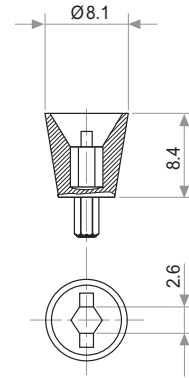

Fig. 6 / Ref. 5035

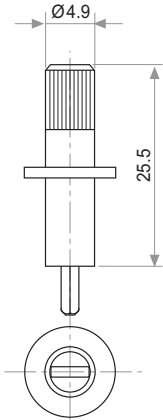

Fig. 7 / Ref. 5115

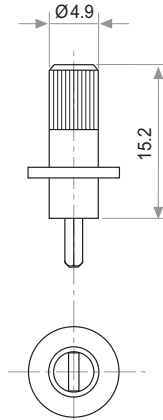

Fig. 8 / Ref. 5116

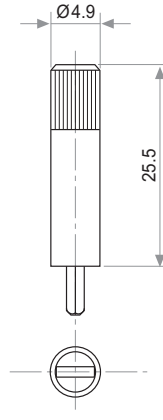

Fig. 9 / Ref. 5119

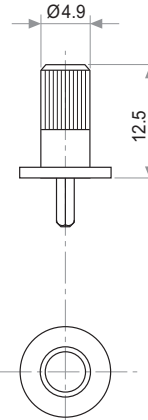

Fig. 10 / Ref. 5120

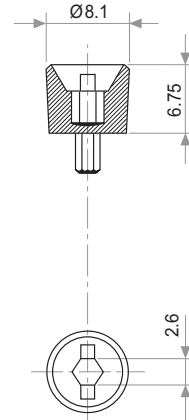

Fig. 11 / Ref. 5027

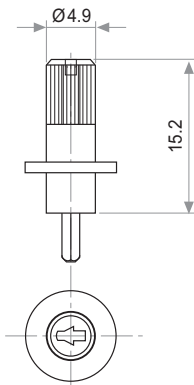

Fig. 12 / Ref. 6052

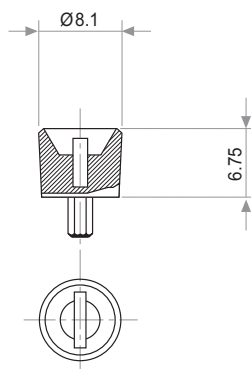

Fig. 13 / Ref. 5121

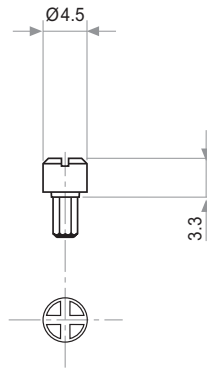

Fig. 14 / Ref. 5055

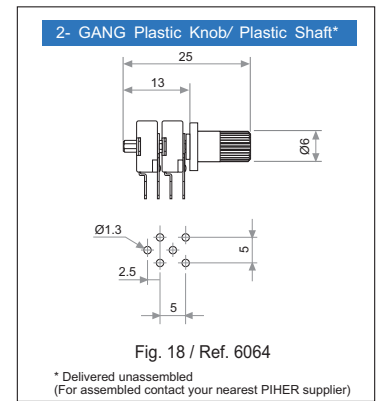

Fig. 18 / Ref. 6064

* Delivered unassembled
(For assembled contact your nearest PIHER supplier)

THUMBWHEELS

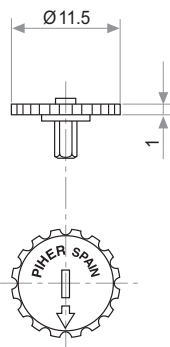

Fig. 5 / Ref. 5034

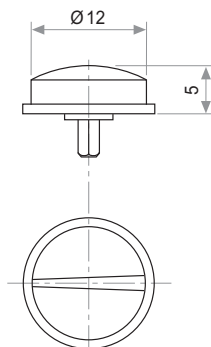

Fig. 15 / Ref. 6008

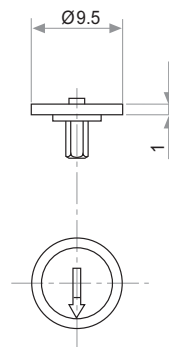

Fig. 16 / Ref. 5039

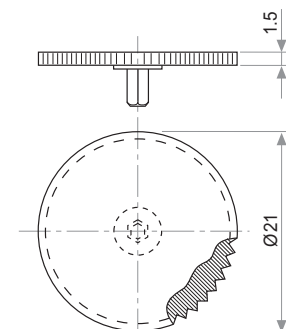

Fig. 17 / Ref. 5062