

8MHz, Precision, JFET Input Operational Amplifier

November 1996

Features

- Low Offset Voltage.....100 μ V
- Low Offset Voltage Drift2 μ V/ $^{\circ}$ C
- Low Noise.....10nV/ $\sqrt{\text{Hz}}$
- High Open Loop Gain600kV/V
- Wide Bandwidth.....8MHz
- Unity Gain Stable

Applications

- High Gain Instrumentation Amplifiers
- Precision Data Acquisition
- Precision Integrators
- Precision Threshold Detectors
- For Further Design Ideas, Refer to Application Note 540

Ordering Information

PART NUMBER	TEMP. RANGE ($^{\circ}$ C)	PACKAGE	PKG. NO.
HA2-5170-2	-55 to 125	8 Pin Metal Can	T8.C
HA2-5170-5	0 to 75	8 Pin Metal Can	T8.C
HA7-5170-2	-55 to 125	8 Ld CERDIP	F8.3A
HA7-5170-5	0 to 75	8 Ld CERDIP	F8.3A

Description

The Harris HA-5170 is a precision, JFET input, operational amplifier which features low noise, low offset voltage and low offset voltage drift. Constructed using FET/Bipolar technology, the Harris Dielectric Isolation (DI) process, and laser trimming this amplifier offers low input bias and offset currents. This operational amplifier design also completely eliminates the troublesome errors due to warm-up drift.

Complementing these excellent input characteristics are dynamic performance characteristics never before available from precision operational amplifiers. An 8V/ μ s slew rate and 8MHz bandwidth allow the designer to extend precision instrumentation applications in both speed and bandwidth. These characteristics make the HA-5170 well suited for precision integrator amplifier designs.

The superior input characteristics also make the HA-5170 ideally suited for transducer signal amplifiers, precision voltage followers and precision data acquisition systems. For application assistance, please refer to Application Note AN540 addressing specifically this device.

Military version (-8) product and data sheets available upon request.

Pinouts

HA-5170
(CERDIP)
TOP VIEW

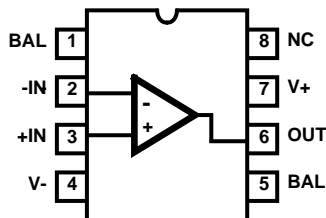

HA-5170
(METAL CAN)
TOP VIEW

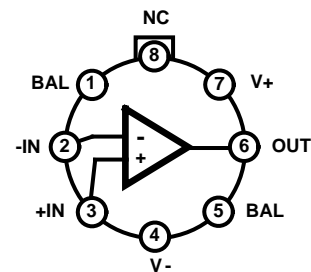

HA-5170

Absolute Maximum Ratings

Voltage Between V+ and V- Terminals 44V
 Differential Input Voltage..... 30V
 Output Short Circuit Duration..... Indefinite

Operating Conditions

Temperature Range
 HA-5170-2..... -55°C to 125°C
 HA-5170-5..... 0°C to 75°C

Thermal Information

Thermal Resistance (Typical, Note 1) θ_{JA} (°C/W) θ_{JC} (°C/W)
 CERDIP Package 135 50
 Metal Can Package 155 67
 Maximum Junction Temperature..... 175°C
 Maximum Storage Temperature Range -65°C to 150°C
 Maximum Lead Temperature (Soldering 10s)..... 300°C

CAUTION: Stresses above those listed in "Absolute Maximum Ratings" may cause permanent damage to the device. This is a stress only rating and operation of the device at these or any other conditions above those indicated in the operational sections of this specification is not implied.

NOTE:

- θ_{JA} is measured with the component mounted on an evaluation PC board in free air.

Electrical Specifications $V_{SUPPLY} = \pm 15V$, Unless Otherwise Specified

PARAMETER	TEST CONDITIONS	TEMP. (°C)	HA-5170-2 -55°C to 125°C			HA-5170-5 0°C to 75°C			UNITS
			MIN	TYP	MAX	MIN	TYP	MAX	
INPUT CHARACTERISTICS									
Offset Voltage		25	-	0.1	0.3	-	0.1	0.3	mV
		Full	-	-	0.5	-	-	0.5	mV
Average Offset Voltage Drift (Note 3)		Full	-	2	5	-	2	5	$\mu V/^\circ C$
Bias Current		25	-	20	100	-	20	100	pA
		Full	-	3	30	-	0.1	2	nA
Bias Current Average Drift		Full	-	3	-	-	3	-	$pA/^\circ C$
Offset Current		25	-	3	30	-	3	60	pA
		Full	-	-	5	-	-	0.1	nA
Offset Current Average Drift (Note 3)		Full	-	0.3	1	-	0.3	1	$pA/^\circ C$
Common Mode Range		Full	± 10	+15.1	-	± 10	+15.1	-	V
		Full		-12	-	-	-12	-	V
Differential Input Capacitance		25	-	80	100	-	80	100	pF
Differential Input Resistance (Note 3)		25	1×10^{10}	6×10^{10}	-	1×10^{10}	6×10^{10}	-	Ω
Input Capacitance (Single Ended)		25	-	12	-	-	12	-	pF
Input Noise Voltage (Note 3)	0.1Hz to 10Hz	25	-	0.5	5	-	0.5	5	μV_{P-P}
Input Noise Voltage Density (Note 3)	f = 10Hz	25	-	20	150	-	20	150	nV/\sqrt{Hz}
	f = 100Hz	25	-	12	50	-	12	50	nV/\sqrt{Hz}
	f = 1000Hz	25	-	10	25	-	10	25	nV/\sqrt{Hz}
Input Noise Current Density (Note 3)	f = 10Hz	25	-	0.05	-	-	0.05	-	pA/\sqrt{Hz}
	f = 100Hz	25	-	0.01	-	-	0.01	-	pA/\sqrt{Hz}
	f = 1000Hz	25	-	0.01	0.1	-	0.01	0.1	pA/\sqrt{Hz}

HA-5170

Electrical Specifications $V_{SUPPLY} = \pm 15V$, Unless Otherwise Specified (Continued)

PARAMETER	TEST CONDITIONS	TEMP. (°C)	HA-5170-2 -55°C to 125°C			HA-5170-5 0°C to 75°C			UNITS
			MIN	TYP	MAX	MIN	TYP	MAX	
TRANSFER CHARACTERISTICS									
Large Signal Voltage Gain	$V_{OUT} = \pm 10V$, $R_L = 2k\Omega$	25	300	600	-	300	600	-	kV/V
		Full	200	-	-	250	-	-	kV/V
Common Mode Rejection Ratio	$\Delta V_{CM} = \pm 10V$	Full	85	100	-	90	100	-	dB
Minimum Stable Gain		25	1	-	-	1	-	-	V/V
Closed Loop Bandwidth	$A_{VCL} = +1$	25	4	8	-	4	8	-	MHz
OUTPUT CHARACTERISTICS									
Output Voltage Swing	$R_L = 2k\Omega$	25	± 10	± 12	-	± 10	± 12	-	V
Full Power Bandwidth (Note 4)	$R_L = 2k\Omega$	25	80	120	-	80	120	-	kHz
Output Current (Note 5)	$V_{OUT} = \pm 10V$	25	± 10	± 15	-	± 10	± 15	-	mA
Output Resistance (Note 3)	Open Loop, 100Hz	25	-	45	100	-	45	100	Ω
TRANSIENT RESPONSE									
Rise Time	Note 2	25	-	45	100	-	45	100	ns
Slew Rate	Note 2	25	5	8	-	5	8	-	V/ μ s
Settling Time (Notes 3, 7)		25	-	1	5	-	1	5	μ s
POWER SUPPLY CHARACTERISTICS									
Supply Current		Full	-	1.9	2.5	-	1.9	2.5	mA
Power Supply Rejection Ratio (Note 8)		Full	85	105	-	90	105	-	dB

NOTES:

2. See "Test Circuits and Waveforms" section.
3. Parameter is not 100% tested. 90% of all units meet or exceed these specifications.
4. Full power bandwidth guaranteed based on slew rate measurement using: $FPBW = \frac{\text{Slew Rate}}{2\pi V_{PEAK}}$.
5. I_{SC} turns on at $\approx 23mA$.
6. Settling time is measured to 0.1% of final value for a 10V output step and $A_V = -1$.
7. $V_+ = +15V$, $V_- = -10V$ to $-20V$ and $V_- = -15V$, $V_+ = +10V$ to $+20V$.

Test Circuits and Waveforms

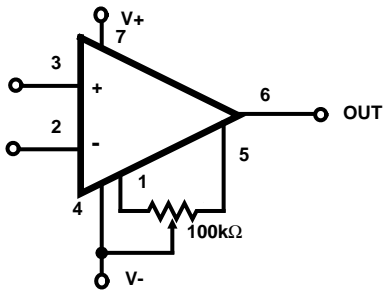

Tested Offset Adjustment Range is $|V_{OS} + 1mV|$ minimum referred to output. Typical range is $\pm 5mV$ with $R_T = 1k\Omega$ and $\pm 15mV$ with $R_T = 100k\Omega$.

FIGURE 1. V_{OS} ADJUSTMENT

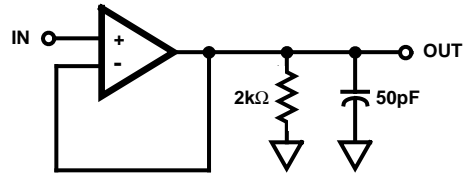
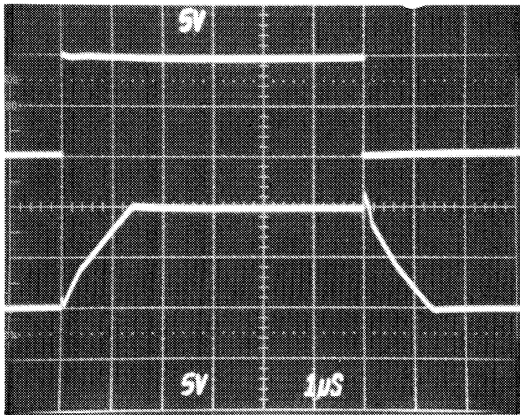
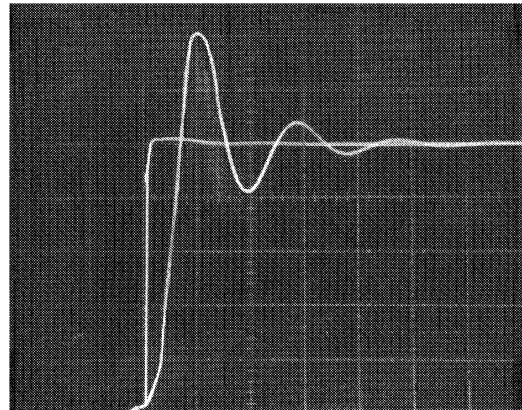

FIGURE 2. LARGE AND SMALL SIGNAL RESPONSE CIRCUIT



Vertical Scale: 5V/Div.
Horizontal Scale: 1 μ s/Div.

LARGE SIGNAL RESPONSE



Vertical Scale: 10mV/Div.
Horizontal Scale: 100ns/Div.

SMALL SIGNAL RESPONSE

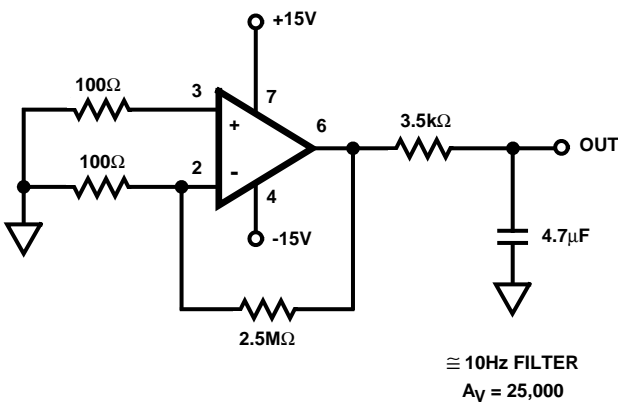
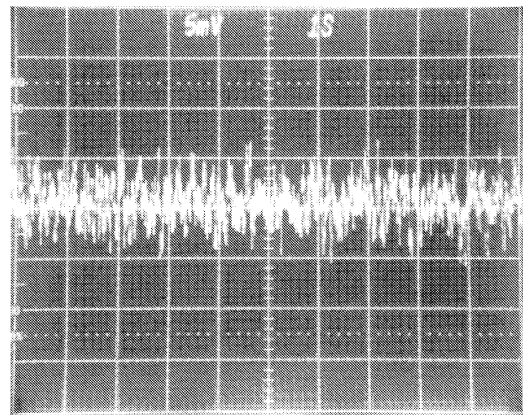

FIGURE 3. LOW FREQUENCY NOISE TEST CIRCUIT



Vertical Scale: 200nV/Div. (Noise Referred to Input)
5mV/Div. at Output, $A_{VCL} = 25,000$
Horizontal Scale: 1s/Div.

HA-5170 LOW FREQUENCY NOISE (0.1Hz TO 10Hz)

Schematic Diagram

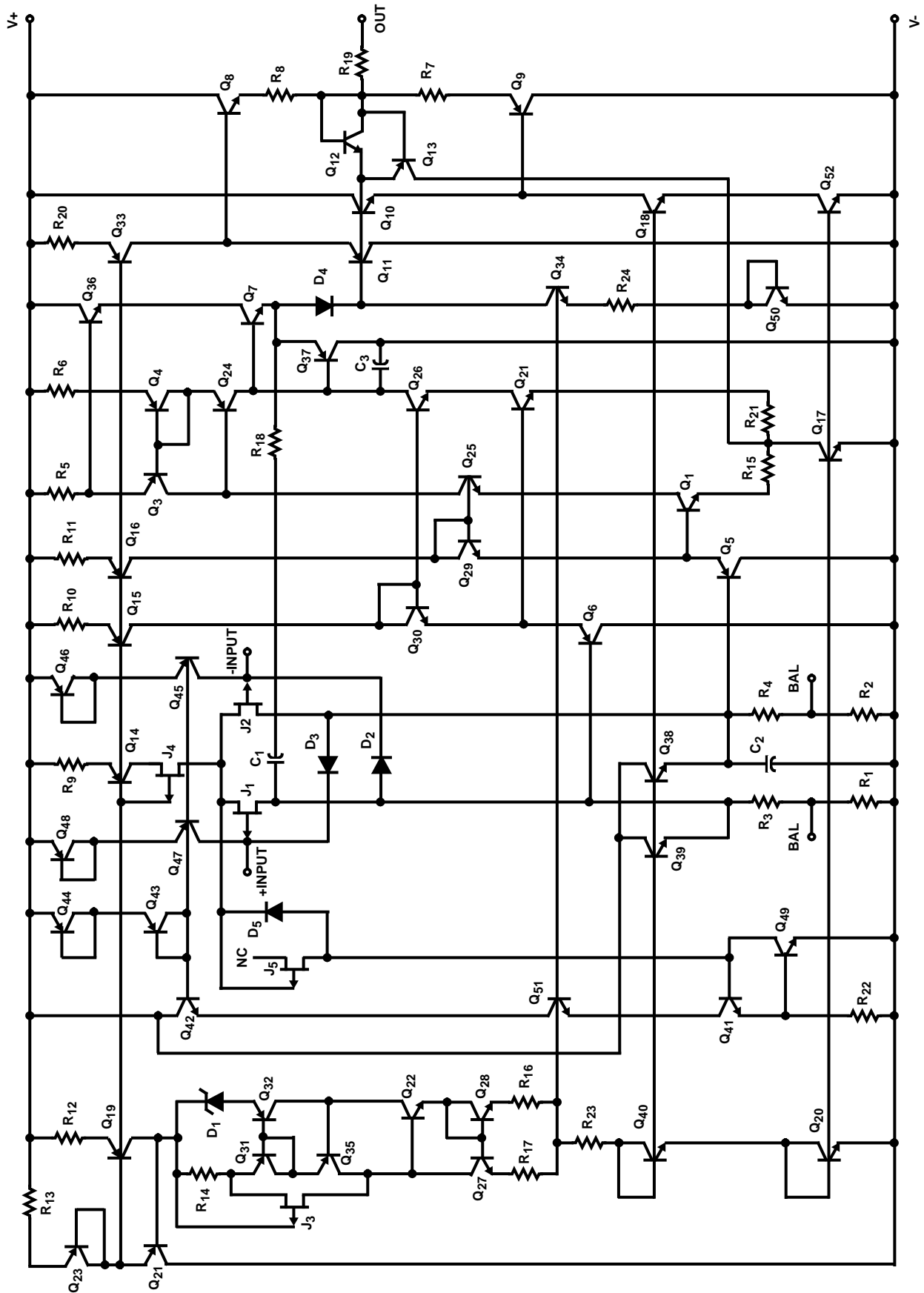

Typical Performance Curves

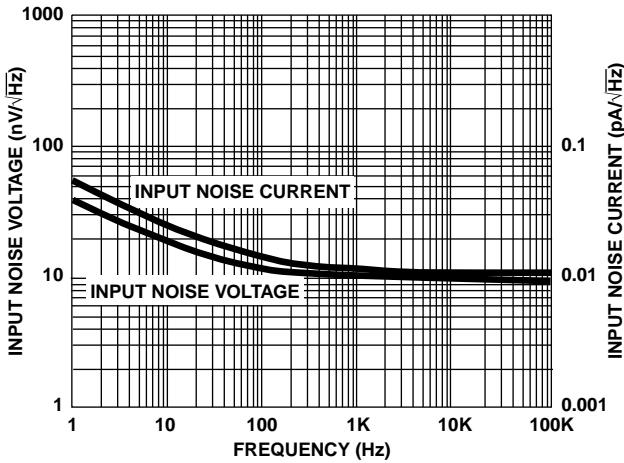

FIGURE 4. INPUT NOISE vs FREQUENCY

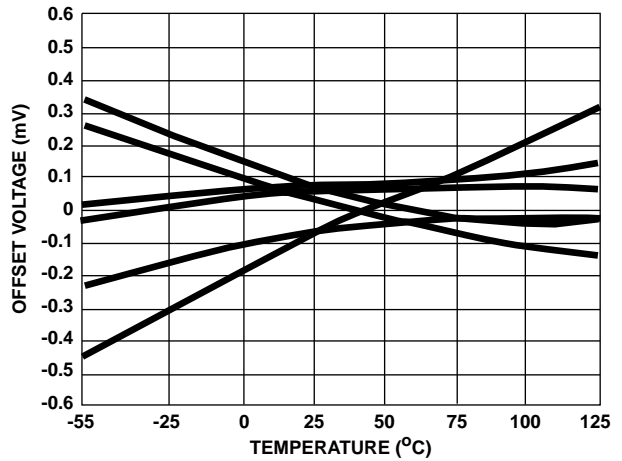

FIGURE 5. OFFSET VOLTAGE DRIFT vs TEMPERATURE OF REPRESENTATIVE UNITS

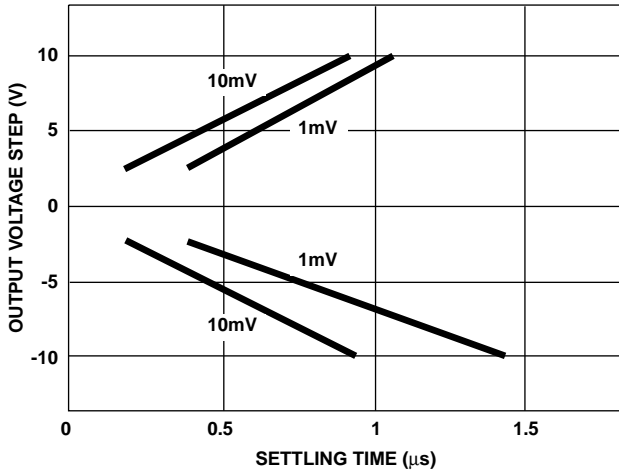

FIGURE 6. SETTLING TIME FOR VARIOUS OUTPUT STEP VOLTAGES

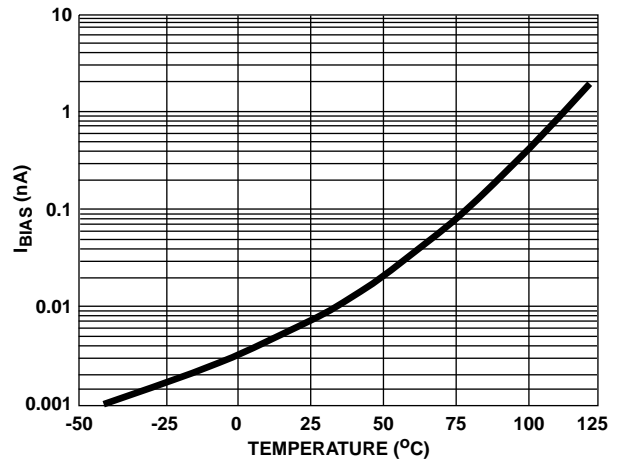

FIGURE 7. BIAS CURRENT vs TEMPERATURE

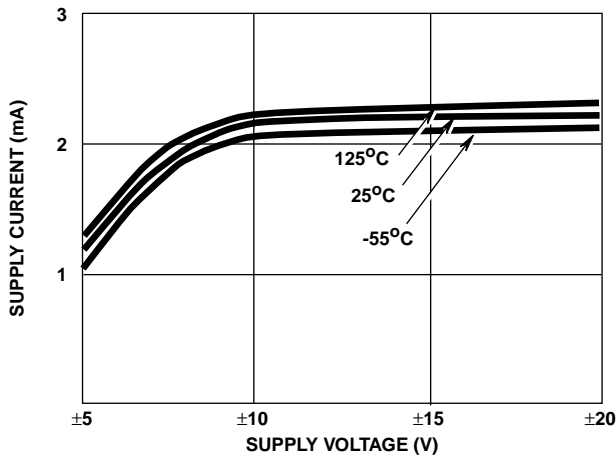

FIGURE 8. POWER SUPPLY CURRENT vs SUPPLY VOLTAGE

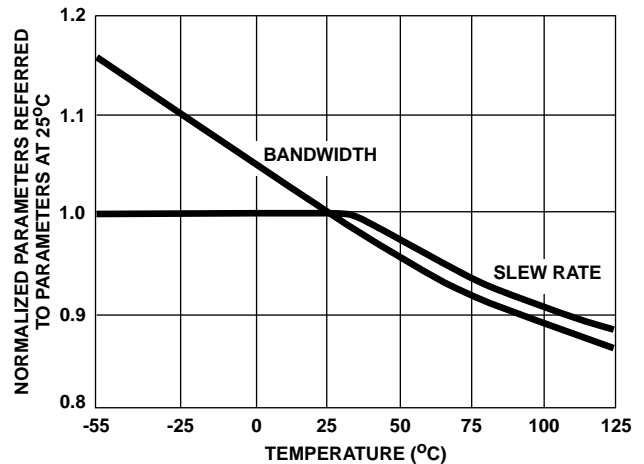

FIGURE 9. NORMALIZED AC PARAMETERS vs TEMPERATURE

Typical Performance Curves (Continued)

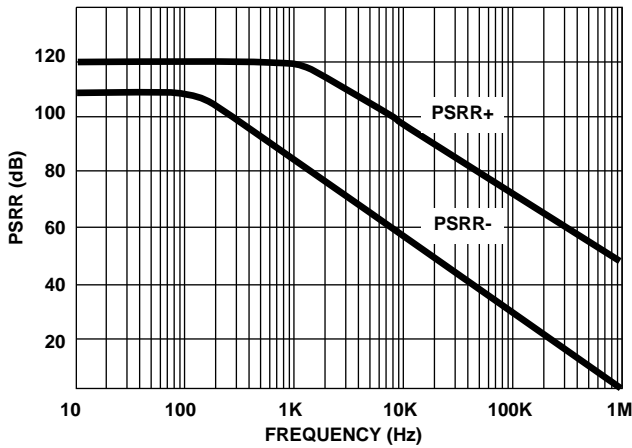

FIGURE 10. POWER SUPPLY REJECTION RATIO vs FREQUENCY

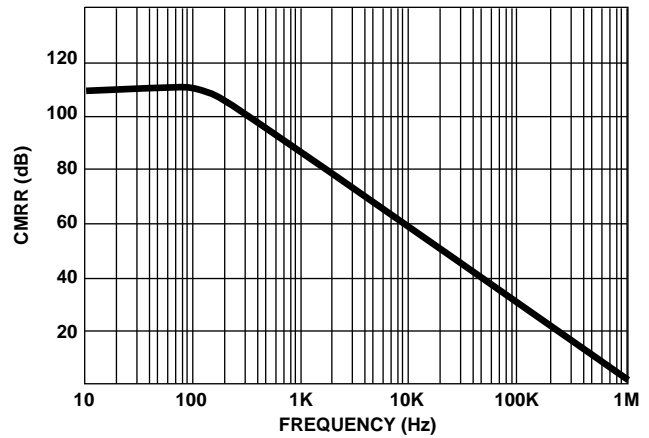

FIGURE 11. COMMON MODE REJECTION RATIO vs FREQUENCY

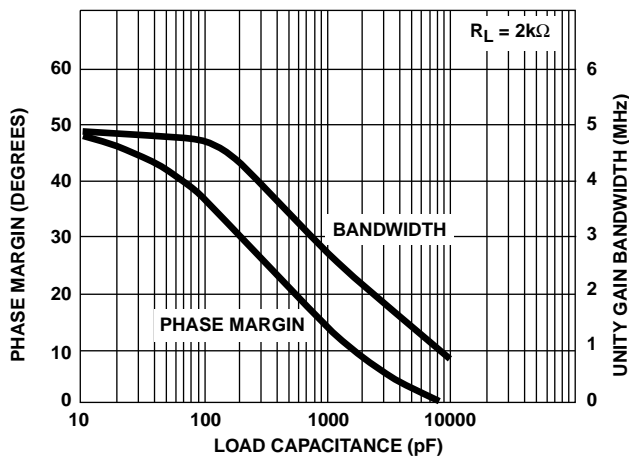

FIGURE 12. SMALL SIGNAL BANDWIDTH AND PHASE MARGIN vs LOAD CAPACITANCE

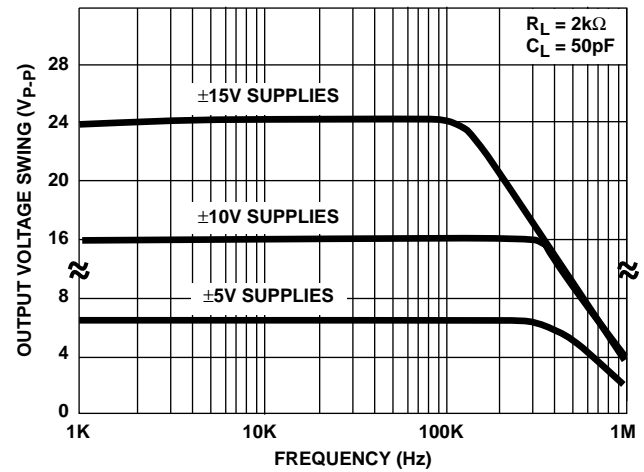

FIGURE 13. OUTPUT VOLTAGE SWING vs FREQUENCY AND SUPPLY VOLTAGE

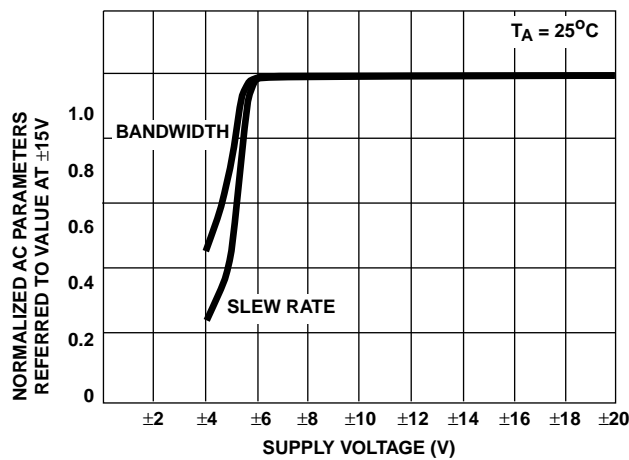

FIGURE 14. NORMALIZED AC PARAMETERS vs SUPPLY VOLTAGE

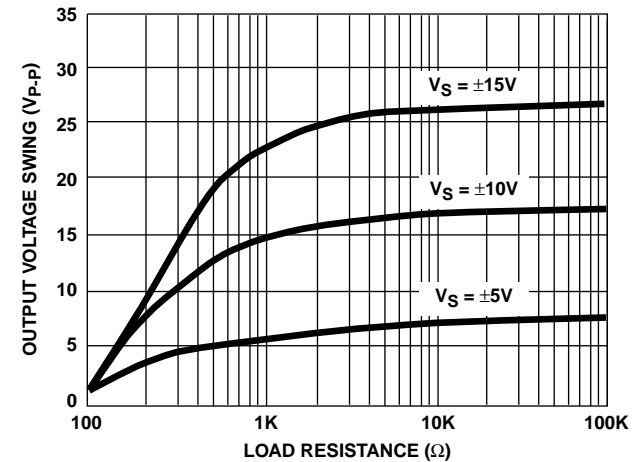

FIGURE 15. MAXIMUM OUTPUT VOLTAGE SWING vs LOAD RESISTANCE

Typical Performance Curves (Continued)

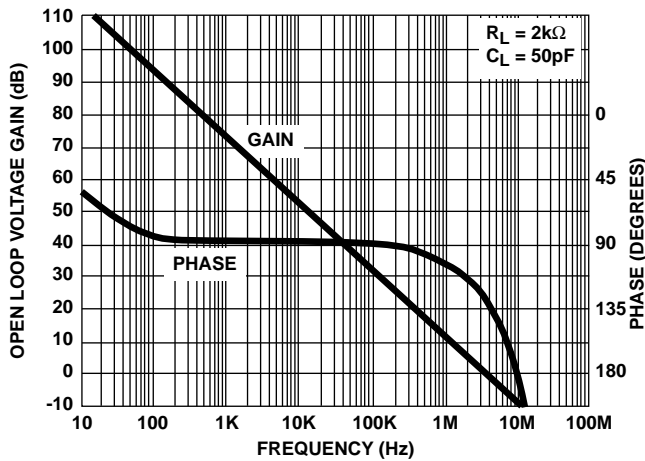

FIGURE 16. OPEN LOOP FREQUENCY RESPONSE

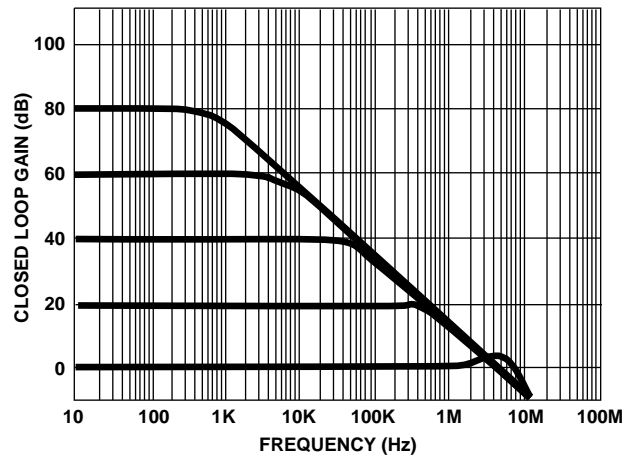

FIGURE 17. CLOSED LOOP FREQUENCY RESPONSE FOR VARIOUS CLOSED LOOP GAINS

All Harris Semiconductor products are manufactured, assembled and tested under **ISO9000** quality systems certification.

Harris Semiconductor products are sold by description only. Harris Semiconductor reserves the right to make changes in circuit design and/or specifications at any time without notice. Accordingly, the reader is cautioned to verify that data sheets are current before placing orders. Information furnished by Harris is believed to be accurate and reliable. However, no responsibility is assumed by Harris or its subsidiaries for its use; nor for any infringements of patents or other rights of third parties which may result from its use. No license is granted by implication or otherwise under any patent or patent rights of Harris or its subsidiaries.

Sales Office Headquarters

For general information regarding Harris Semiconductor and its products, call **1-800-4-HARRIS**

NORTH AMERICA
 Harris Semiconductor
 P. O. Box 883, Mail Stop 53-210
 Melbourne, FL 32902
 TEL: 1-800-442-7747
 (407) 729-4984
 FAX: (407) 729-5321

EUROPE
 Harris Semiconductor
 Mercure Center
 100, Rue de la Fusee
 1130 Brussels, Belgium
 TEL: (32) 2.724.2111
 FAX: (32) 2.724.22.05

ASIA
 Harris Semiconductor PTE Ltd.
 No. 1 Tannery Road
 Cencon 1, #09-01
 Singapore 1334
 TEL: (65) 748-4200
 FAX: (65) 748-0400

