

## LM140L/LM340L Series 3-Terminal Positive Regulators

### General Description

The LM140L series of three terminal positive regulators is available with several fixed output voltages making them useful in a wide range of applications. The LM140LA is an improved version of the LM78LXX series with a tighter output voltage tolerance (specified over the full military temperature range), higher ripple rejection, better regulation and lower quiescent current. The LM140LA regulators have  $\pm 2\%$   $V_{OUT}$  specification, 0.04%/V line regulation, and 0.01%/mA load regulation. When used as a zener diode/resistor combination replacement, the LM140LA usually results in an effective output impedance improvement of two orders of magnitude, and lower quiescent current. These regulators can provide local on card regulation, eliminating the distribution problems associated with single point regulation. The voltages available allow the LM140LA to be used in logic systems, instrumentation, Hi-Fi, and other solid state electronic equipment. Although designed primarily as fixed voltage regulators, these devices can be used with external components to obtain adjustable voltages and currents.

The LM140LA/LM340LA are available in the low profile metal three lead TO-39 (H) and the LM340LA are also available in the plastic TO-92 (Z). With adequate heat sinking the regulator can deliver 100 mA output current. Current limiting is included to limit the peak output current to a safe value. Safe area protection for the output transistor is provided to limit internal power dissipation. If internal power dissipation

becomes too high for the heat sinking provided, the thermal shut-down circuit takes over, preventing the IC from overheating.

For applications requiring other voltages, see LM117L Data Sheet.

### Features

- Line regulation of 0.04%/V
- Load regulation of 0.01%/mA
- Output voltage tolerances of  $\pm 2\%$  at  $T_j = 25^\circ\text{C}$  and  $\pm 4\%$  over the temperature range (LM140LA)  $\pm 3\%$  over the temperature range (LM340LA)
- Output current of 100 mA
- Internal thermal overload protection
- Output transistor safe area protection
- Internal short circuit current limit
- Available in metal TO-39 low profile package (LM140LA/LM340LA) and plastic TO-92 (LM340LA)

### Output Voltage Options

LM140LA-5.0	5V	LM340LA-5.0	5V
LM140LA-12	12V	LM340LA-12	12V
LM140LA-15	15V	LM340LA-15	15V

### Connection Diagrams

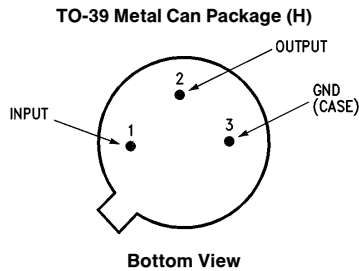

Order Number **LM140LAH-5.0, LM140LAH-5.0/883, LM140LAH-12, LM140LAH-12/883, LM140LAH-15, LM140LAH-15/883, LM340LAH-5.0, LM340LAH-12 or LM340LAH-15**  
See NS Package Number H03A

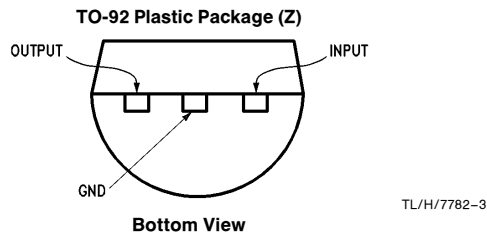

Order Number **LM340LAZ-5.0, LM340LAZ-12 or LM340LAZ-15**  
See NS Package Number Z03A

## Absolute Maximum Ratings

If Military/Aerospace specified devices are required, please contact the National Semiconductor Sales Office/Distributors for availability and specifications. (Note 4)

Input Voltage 35V  
Internal Power Dissipation (Note 1) Internally Limited

Operating Temperature Range  
LM140LA -55°C to +125°C  
LM340LA 0°C to +70°C  
Maximum Junction Temperature +150°C  
Storage Temperature Range  
Metal Can (H package) -65°C to +150°C  
Molded TO-92 -55°C to +150°C  
Lead Temperature (Soldering, 10 sec.)  
Metal Can +300°C  
Plastic TO-92 +230°C

## Electrical Characteristics

Test conditions unless otherwise specified.  $T_A = -55^\circ\text{C}$  to  $+125^\circ\text{C}$  (LM140LA),  $T_A = 0^\circ\text{C}$  to  $+70^\circ\text{C}$  (LM340LA),  $I_O = 40\text{ mA}$ ,  $C_{IN} = 0.33\ \mu\text{F}$ ,  $C_O = 0.01\ \mu\text{F}$ .

Output Voltage Option			5.0V			12V			15V			Units
Input Voltage (unless otherwise noted)			10V			19V			23V			
Symbol	Parameter	Conditions	Min	Typ	Max	Min	Typ	Max	Min	Typ	Max	
$V_O$	Output Voltage	$T_j = 25^\circ\text{C}$	4.9	5	5.1	11.75	12	12.25	14.7	15	15.3	V
	Output Voltage Over Temp. (Note 3)	LM140LA $I_O = 1 - 100\text{ mA}$	4.8	5.2		11.5	12.5		14.4	15.6		
				(7.2-20)			(14.5-27)			(17.6-30)		
		LM340LA $I_O = 1 - 100\text{ mA}$ or $I_O = 1 - 40\text{ mA}$ and $V_{IN} = ( )\text{V}$	4.85	5.15		11.65	12.35		14.55	15.45		
			(7-20)			(14.3-27)			(17.5-30)			
$\Delta V_O$	Line Regulation	$T_j = 25^\circ\text{C}$ $I_O = 40\text{ mA}$ $V_{IN} = ( )\text{V}$	18	30		30	65		37	70		mV
			(7-25)			(14.2-30)			(17.3-30)			
		$I_O = 100\text{ mA}$ $V_{IN} = ( )\text{V}$	18	30		30	65		37	70		
(7.5-25)			(14.5-30)			(17.5-30)						
	Load Regulation	$T_j = 25^\circ\text{C}$ $I_O = 1 - 40\text{ mA}$ $I_O = 1 - 100\text{ mA}$	5	20		10	40		12	50		
			20 40			30 80			35 100			
	Long Term Stability		12			24			30			mV 1000 hrs
$I_O$	Quiescent Current	$T_j = 25^\circ\text{C}$	3	4.5		3	4.5		3.1	4.5		mA
		$T_j = 125^\circ\text{C}$	4.2			4.2			4.2			
$\Delta I_Q$	Quiescent Current Change	$T_j = 25^\circ\text{C}$ $\Delta\text{Load } I_O = 1 - 40\text{ mA}$	0.1			0.1			0.1			mA
			$\Delta\text{Line}$ $V_{IN} = ( )\text{V}$	0.5			0.5			0.5		
				(7.5-25)			(14.3-30)			(17.5-30)		
$V_N$	Output Noise Voltage	$T_j = 25^\circ\text{C}$ (Note 2) $f = 10\text{ Hz} - 10\text{ kHz}$	40			80			90			$\mu\text{V}$
$\frac{\Delta V_{IN}}{\Delta V_{OUT}}$	Ripple Rejection	$f = 120\text{ Hz}$ , $V_{IN} = ( )\text{V}$	55	62		47	54		45	52		dB
			(7.5-18)			(14.5-25)			(17.5-28.5)			
	Input Voltage Required to Maintain Line Regulation	$T_j = 25^\circ\text{C}$ , $I_O = 40\text{ mA}$	7			14.2			17.3			V

**Note 1:** Thermal resistance of H-package is typically 26°C/W  $\theta_{JC}$ , 250°C/W  $\theta_{JA}$  still air, and 94°C/W  $\theta_{JA}$  400 l/min of air. For the Z-package is 60°C/W  $\theta_{JC}$ , 232°C/W  $\theta_{JA}$  still air, and 88°C/W  $\theta_{JA}$  at 400 l/min of air. The maximum junction temperature shall not exceed 125°C on electrical parameters.

**Note 2:** It is recommended that a minimum load capacitor of 0.01  $\mu\text{F}$  be used to limit the high frequency noise bandwidth.

**Note 3:** The temperature coefficient of  $V_{OUT}$  is typically within 0.01%  $V_O/^\circ\text{C}$ .

**Note 4:** A military RETS specification is available upon request. At the time of printing, the LM140LA-5.0, -12, and -15 RETS specifications complied with the Min and Max limits in this table. The LM140LAH-5.0, LM140LAH-12, and LM140LAH-15 may also be procured as Standard Military Drawings.

## Typical Performance Characteristics

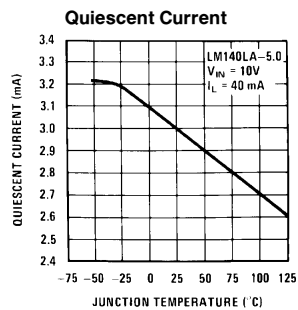
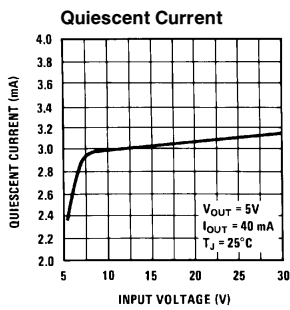
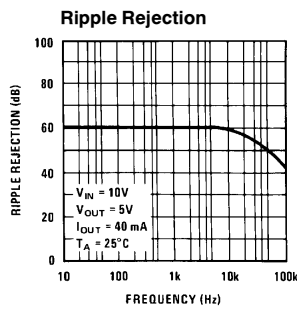
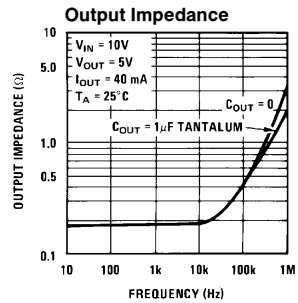
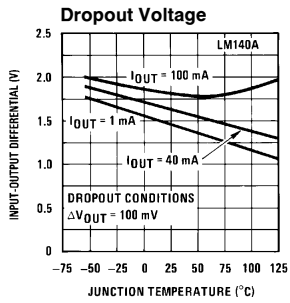
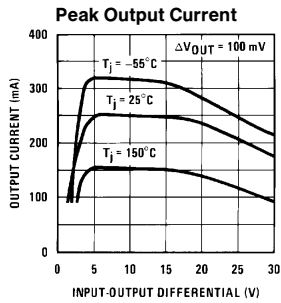
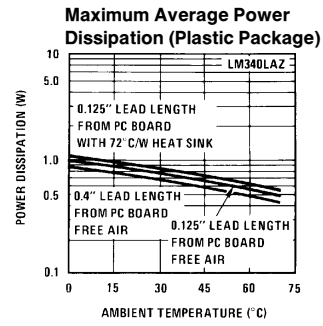
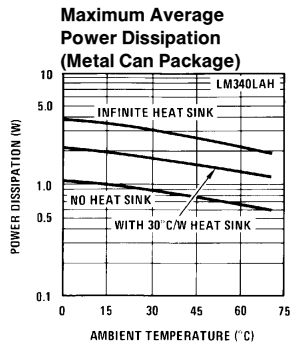
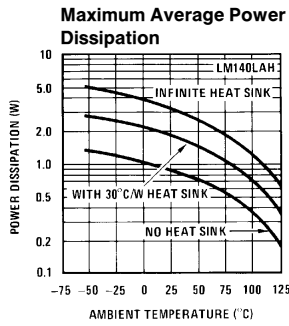

TL/H/7782-4

## Typical Applications

### Fixed Output Regulator

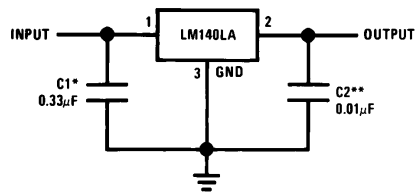

TL/H/7782-5

\*Required if the regulator is located far from the power supply filter.

\*\*See note 3 in the electrical characteristics table.

### Adjustable Output Regulator

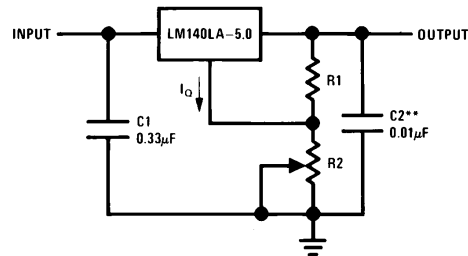

$$V_{OUT} = 5\text{ V} + (5\text{ V}/R1 + I_O) R2$$

$$5\text{ V}/R1 = 3 I_O \text{ load regulation (L)} [(R1 + R2)/R1] \text{ (L of LM140LA-5.0)}$$

TL/H/7782-6

# Equivalent Circuit

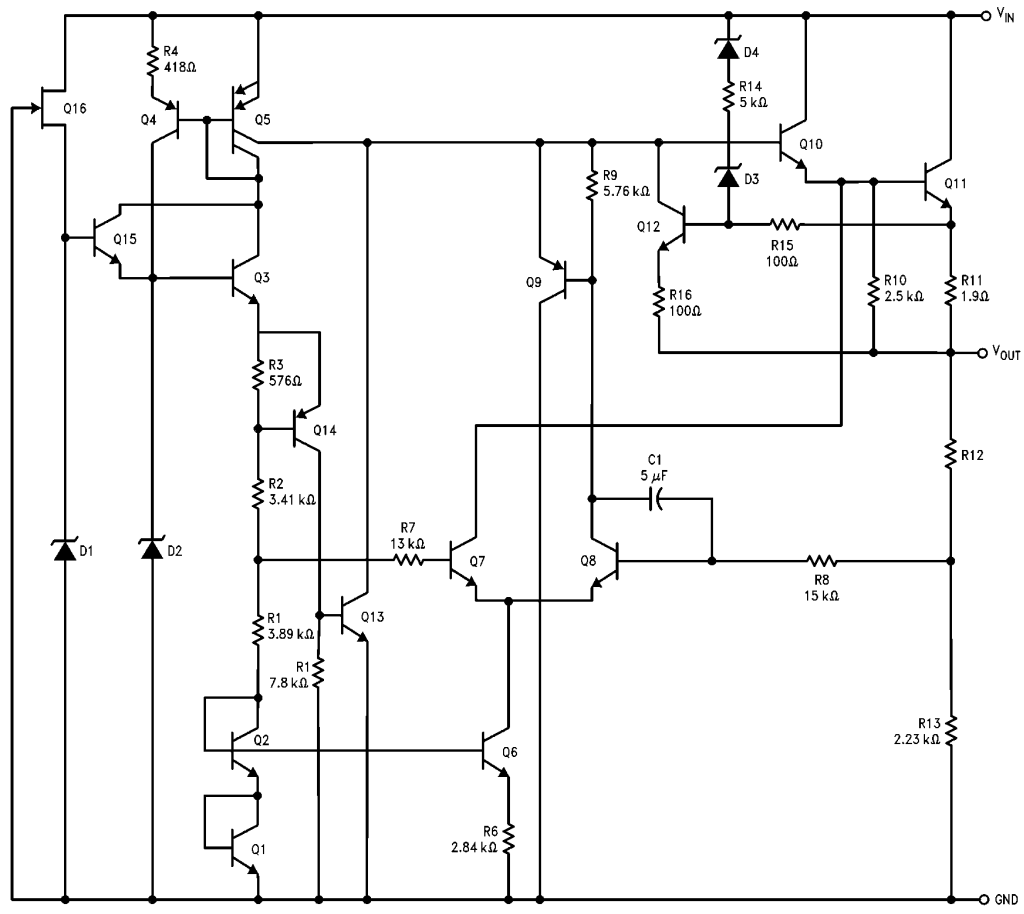

TL/H/7782-1

**Physical Dimensions** inches (millimeters)

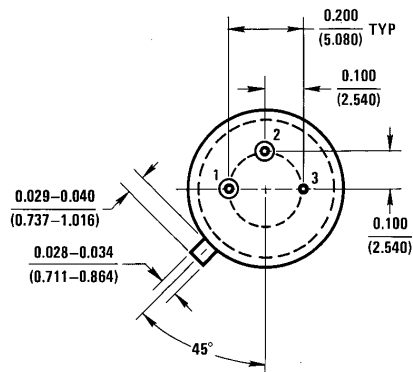
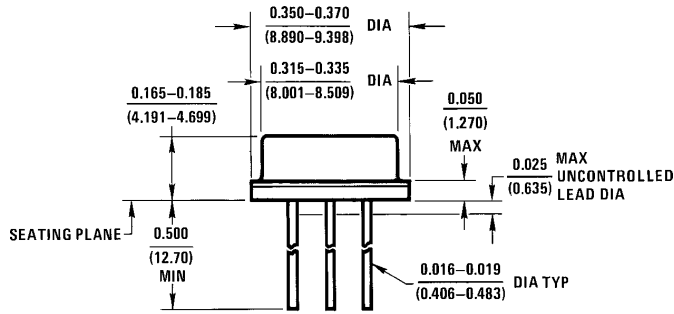

H03A (REV B)

**TO-39 Metal Can Package (H)**  
**Order Number LM140LAH-5.0, LM140LAH-5.0/883, LM140LAH-12, LM140LAH-12/883,**  
**LM140LAH-15, LM140LAH-15/883, LM340LAH-5.0, LM340LAH-12 or LM340LAH-15**  
**NS Package Number H03A**

**Physical Dimensions** inches (millimeters) (Continued)

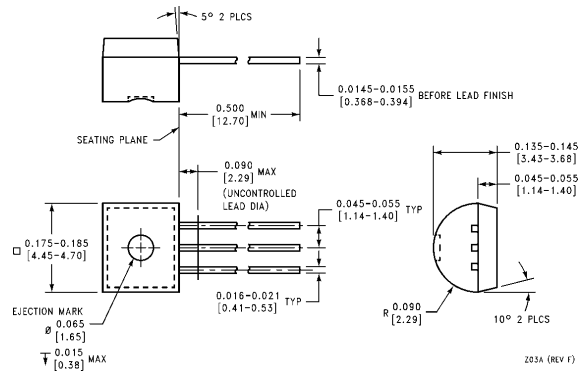

**TO-92 Plastic Package (Z)**  
**Order Number LM340LAZ-5.0, LM340LAZ-12, or LM340LAZ-15**  
**NS Package Number Z03A**

**LIFE SUPPORT POLICY**

NATIONAL'S PRODUCTS ARE NOT AUTHORIZED FOR USE AS CRITICAL COMPONENTS IN LIFE SUPPORT DEVICES OR SYSTEMS WITHOUT THE EXPRESS WRITTEN APPROVAL OF THE PRESIDENT OF NATIONAL SEMICONDUCTOR CORPORATION. As used herein:

1. Life support devices or systems are devices or systems which, (a) are intended for surgical implant into the body, or (b) support or sustain life, and whose failure to perform, when properly used in accordance with instructions for use provided in the labeling, can be reasonably expected to result in a significant injury to the user.
2. A critical component is any component of a life support device or system whose failure to perform can be reasonably expected to cause the failure of the life support device or system, or to affect its safety or effectiveness.



**National Semiconductor Corporation**  
 1111 West Bardin Road  
 Arlington, TX 76017  
 Tel: 1(800) 272-9959  
 Fax: 1(800) 737-7018

**National Semiconductor Europe**  
 Fax: (+49) 0-180-530 85 86  
 Email: cnjwge@tevm2.nsc.com  
 Deutsch Tel: (+49) 0-180-530 85 85  
 English Tel: (+49) 0-180-532 78 32  
 Français Tel: (+49) 0-180-532 93 58  
 Italiano Tel: (+49) 0-180-534 16 80

**National Semiconductor Hong Kong Ltd.**  
 19th Floor, Straight Block,  
 Ocean Centre, 5 Canton Rd.  
 Tsimshatsui, Kowloon  
 Hong Kong  
 Tel: (852) 2737-1600  
 Fax: (852) 2736-9960

**National Semiconductor Japan Ltd.**  
 Tel: 81-043-299-2309  
 Fax: 81-043-299-2408

National does not assume any responsibility for use of any circuitry described, no circuit patent licenses are implied and National reserves the right at any time without notice to change said circuitry and specifications.