

## Vitreous Wirewound Resistors

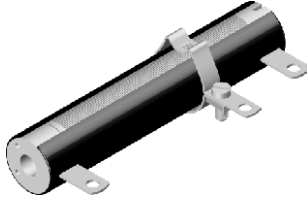

### FEATURES

- All welded construction
- Ceramic core
- Models acc. MIL-R-26 available
- Complete vitreous coating for perfect humidity protection
- Available in adjustable = "E" or non inductive design = "Ni"
- TCR 100...180 ppm/K - WM110 (Class 3)



STANDARD ELECTRICAL SPECIFICATIONS							
GLOBAL MODEL	HISTORICAL MODEL	POWER RATING $P_{40^{\circ}\text{C}}$ W	LIMITING VOLTAGE V	RESISTANCE RANGE (1) $\Omega$	TOLERANCE $\pm \%$	E-SERIES	
RW010440	RW 10 x 44	18	400	1R0 - 3R9	10	E 12	
				4R3 - 36K	10	E 12	
				7R5 - 36K	5	E 24	
RW010441	RW 10 x 44 E	11		1R0 - 6R2	10	E 12	
				6R8 - 1K6	10	E 12	
				6R8 - 1K6	5	E 24	
RW010442	RW 10 x 44 Ni	11		6R2 - 2K4	10	E 12	
				6R2 - 2K4	5	E 24	
RW012250	RW 12 x 25	11		120	R39 - 3R3	10	E 12
			3R6 - 13K		10	E 12	
			33R - 13K		5	E 24	
RW012380	RW 12 x 38	15	350		1R0 - 3R6	10	E 12
					3R9 - 33K	10	E 12
					5R6 - 33K	5	E 24
RW012381	RW 12 x 38 E	14			-	-	-
					4R3 - 1K5	10	E 12
					5R6 - 1K5	5	E 24
RW012382	RW 12 x 38 Ni	14		5R6 - 2K2	10	E 12	
				5R6 - 2K2	5	E 24	
RW012510	RW 12 x 51	25		600	1R0 - 3R9	10	E 12
			4R3 - 56K		10	E 12	
			5R6 - 56K		5	E 24	
RW012511	RW 12 x 51 E	17	1R0 - 6R2		10	E 12	
			6R8 - 2K4		10	E 12	
			6R8 - 2K4		5	E 24	
RW012512	RW 12 x 51 Ni	17	9R1 - 3K6		10	E 12	
			9R1 - 3K6		5	E 24	

### Note

(1) Values in the first line of 10 % tolerance are produced with corrugated ribbon.



<b>STANDARD ELECTRICAL SPECIFICATIONS</b>							
<b>GLOBAL MODEL</b>	<b>HISTORICAL MODEL</b>	<b>POWER RATING <math>P_{40\text{ }^\circ\text{C}}</math> W</b>	<b>LIMITING VOLTAGE V</b>	<b>RESISTANCE RANGE <sup>(1)</sup> <math>\Omega</math></b>	<b>TOLERANCE <math>\pm</math> %</b>	<b>E-SERIES</b>	
RW012760	RW 12 x 76	45	1000	2R0 - 7R5	10	E 12	
				8R2 - 91K	10	E 12	
				8R2 - 91K	5	E 24	
RW012761	RW 12 x 76 E	27		2R0 - 12R	10	E 12	
				13R - 4K3	10	E 12	
				13R - 4K3	5	E 24	
RW012762	RW 12 x 76 Ni	27		16R - 6K2	10	E 12	
				16R - 6K2	5	E 24	
RW020760	RW 20 x 76	70		1000	1R0 - 11R	10	E 12
			12R - 75K		10	E 12	
			12R - 75K		5	E 24	
RW020761	RW 20 x 76 E	42	1R0 - 18R		10	E 12	
			20R - 6K8		10	E 12	
			20R - 6K8		5	E 24	
RW020762	RW 20 x 76 Ni	42	24R - 10K		10	E 12	
			24R - 10K		5	E 24	
RW201020	RW 20 x 102	90	1400		3R - 16R	10	E 12
				18R - 110K	10	E 12	
				18R - 110K	5	E 24	
RW201021	RW 20 x 102 E	55		3R - 27R	10	E 12	
				30R - 10K	10	E 12	
				30R - 10K	5	E 24	
RW201022	RW 20 x 102 Ni	55		36R - 15K	10	E 12	
				36R - 15K	5	E 24	
RW301020	RW 30 x 102	130		1600	2R7 - 22R	10	E 12
			24R - 160K		10	E 12	
			24R - 160K		5	E 24	
RW301021	RW 30 x 102 E	80	2R7 - 22R		10	E 12	
			43R - 15K		10	E 12	
			43R - 15K		5	E 24	
RW301520	RW 30 x 152	220	2500		4R7 - 30R	10	E 12
					33R - 200K	10	E 12
					33R - 200K	5	E 24
RW301521	RW 30 x 152 E	130		4R7 - 30R	10	E 12	
				75R - 24K	10	E 12	
				75R - 24K	5	E 24	

**Note**

<sup>(1)</sup> Values in the first line of 10 % tolerance are produced with corrugated ribbon.

STANDARD ELECTRICAL SPECIFICATIONS						
GLOBAL MODEL	HISTORICAL MODEL	POWER RATING $P_{40^{\circ}\text{C}}$ W	LIMITING VOLTAGE V	RESISTANCE RANGE <sup>(1)</sup> $\Omega$	TOLERANCE $\pm$ %	E-SERIES
RW302030	RW 30 x 203	300	3600	6R8 - 43R	10	E 12
				47R - 270K	10	E 12
				47R - 270K	5	E 24
RW302031	RW 30 x 203 E	180	3600	6R8 - 43R	10	E 12
				100R - 36K	10	E 12
				100R - 36K	5	E 24
RW302670	RW 30 x 267	400	5000	8R2 - 68R	10	E 12
				75R - 390K	10	E 12
				75R - 390K	5	E 24
RW302671	RW 30 x 267 E	240	5000	8R2 - 68R	10	E 12
				150R - 47K	10	E 12
				150R - 47K	5	E 24
RW303050	RW 30 x 305	480	6000	10R - 68R	10	E 12
				75R - 300K	10	E 12
				75R - 300K	5	E 24
RW303051	RW 30 x 305 E	290	6000	10R - 68R	10	E 12
				160R - 56K	10	E 12
				160R - 56K	5	E 24
RW000290 <sup>(2)</sup>	RW 29	11	400	7R5 - 3K3	5	E 24
RW000300 <sup>(2)</sup>	RW 30	11	120	33R - 1K1	5	E 24
RW000310 <sup>(2)</sup>	RW 31	14	350	5R6 - 3K	5	E 24
RW000320 <sup>(2)</sup>	RW 32	17	600	5R6 - 4K7	5	E 24
RW000330 <sup>(2)</sup>	RW 33	26	1000	8R2 - 8K2	5	E 24
RW000350 <sup>(2)</sup>	RW 35	55	1400	18R - 20K	5	E 24
RW000360 <sup>(2)</sup>	RW 36	78	1600	24R - 30K	5	E 24
RW000370 <sup>(2)</sup>	RW 37	113	2500	33R - 47K	5	E 24
RW000380 <sup>(2)</sup>	RW 38	159	3600	47R - 68K	5	E 24
RW000470 <sup>(2)</sup>	RW 47	210	5000	75R - 91K	5	E 24

**Notes**

<sup>(1)</sup> Values in the first line of 10 % tolerance are produced with corrugated ribbon.

<sup>(2)</sup> Model according to MIL-R-26.



**GLOBAL PART NUMBER INFORMATION**

New Global Part Numbering: RW0104411009JLX000 (preferred part number format)

R W 0 1 0 4 4 1 1 0 0 9 J L X 0 0 0

MODEL	SIZE	SPECIAL CHARACTER	VALUE	TOLERANCE	PACKAGING	SPECIAL
RW	01044 = 10/44 01225 = 12/25 01238 = 12/38 01251 = 12/51 01276 = 12/76 02076 = 20/76 20102 = 20/102 30102 = 30/102 30152 = 30/152 30203 = 30/203 30267 = 30/267 30305 = 30/305 00029 = 29 00030 = 30 00031 = 31 00032 = 32 00033 = 33 00035 = 35 00036 = 36 00037 = 37 00038 = 38 00047 = 47	0 = Neutral 1 = E 2 = NI 7 = FST C = E FST H = NI FST Z = Value overflow (BV)  (Note: NI is also known as SWI)	<b>3 digit value</b> <b>1 digit multiplier</b> <b>MULTIPLIER</b> 7 = $\times 10^{-3}$ 8 = $\times 10^{-2}$ 9 = $\times 10^{-1}$ 0 = $\times 10^0$ 1 = $\times 10^1$ 2 = $\times 10^2$ 3 = $\times 10^3$ 4 = $\times 10^4$	J = $\pm 5.0\%$ K = $\pm 10.0\%$	(see Packaging table)	The 5 digit BV number will be encoded using a 36 character code. This code contains numbers 0...9 and letters A...Z (36 characters total) and allows to encode at least 46 655 five digit BV numbers. <b>000 = Standard</b>

Historical Part Number Example: RW 10/44 E 10R 5% (will continue to be accepted)

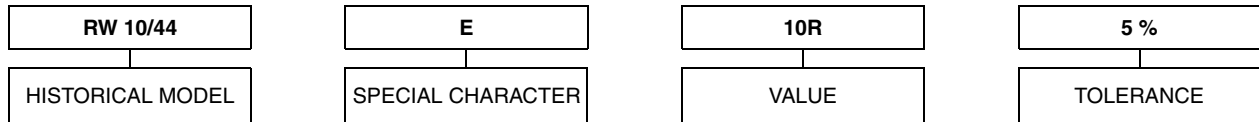

**PACKAGING TABLE**

SAP	DESCRIPTION	TYPE
LX	Loose pack, without quantity	all
ZX	Special pack (with BV #), without quantity  <b>Note:</b> LX = B29 on Dale legacy ZX = S51 on Dale legacy	all

**DIMENSIONS** in millimeters [inches]

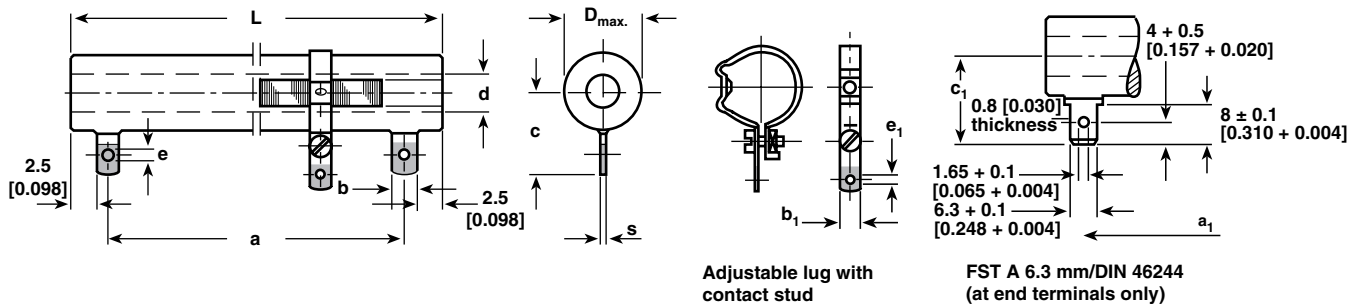

MODEL		DIMENSIONS in millimeters [inches]					
		RW 10/44 RW 10/44 E RW 10/44 Ni RW 29 <sup>(2)</sup>	RW 12/25  RW 30 <sup>(2)</sup>	RW 12/38 RW 12/38 E RW 12/38 Ni RW 31 <sup>(2)</sup>	RW 12/51 RW 12/51 E RW 12/51 Ni RW 32 <sup>(2)</sup>	RW 12/76 RW 12/76 E RW 12/76 Ni RW 33 <sup>(2)</sup>	RW 20/76 RW 20/76 E RW 20/76 Ni
MM	D <sub>max.</sub> <sup>(1)</sup>	12.7 (15.7) [0.5 (0.618)]	15.1 (18.1) [0.595 (0.713)]	15.1 (18.1) [0.595 (0.713)]	15.1 (18.1) [0.595 (0.713)]	15.1 (18.1) [0.595 (0.713)]	23 (26) [0.906 (1.024)]
	L ± 1.6 mm	44.4 [1.748]	25.4 [1.000]	38.1 [1.500]	50.8 [2.000]	76.2 [3.000]	76.2 [3.000]
	a	33.4 [1.315]	14.4 [0.570]	27.1 [1.070]	39.8 [1.570]	65.2 [2.570]	63.2 [2.490]
	a <sub>1</sub>	31.4 [1.236]	-	25.1 [0.990]	37.8 [1.490]	63.2 [2.490]	63.2 [2.490]
	b	6 [0.236]	6 [0.240]	6 [0.240]	6 [0.240]	6 [0.240]	8 [0.310]
	b <sub>1</sub>	5 [0.197]	-	5 [0.200]	5 [0.200]	5 [0.200]	5 [0.200]
	c	16.5 [0.650]	17.5 [0.690]	17.5 [0.690]	17.5 [0.690]	17.5 [0.690]	22 [0.870]
	c <sub>1</sub>	18.5 [0.728]	-	19 [0.750]	19 [0.750]	19 [0.750]	23 [0.910]
	d	4.5 [0.177]	5.5 [0.220]	5.5 [0.220]	5.5 [0.220]	5.5 [0.220]	12 [0.470]
	e	3.2 [0.126]	3.2 [0.130]	3.2 [0.130]	3.2 [0.130]	3.2 [0.130]	4.2 [0.170]
	e <sub>1</sub>	2.8 [0.110]	-	3.2 [0.130]	3.2 [0.130]	3.2 [0.130]	3.2 [0.130]
	s	0.6 [0.024]	0.6 [0.020]	0.6 [0.020]	0.6 [0.020]	0.6 [0.020]	0.8 [0.030]
	Weight (g)	10	10	10	15	15	30
MODEL		RW 20/102 RW 20/102 E RW 20/102 Ni RW 35 <sup>(2)</sup>	RW 30/102 RW 30/102 E  RW 36 <sup>(2)</sup>	RW 30/152 RW 30/152 E  RW 37 <sup>(2)</sup>	RW 30/203 RW 30/203  RW 38 <sup>(2)</sup>	RW 30/267 RW 30/267 E  RW 47 <sup>(2)</sup>	RW 30/305 RW 30/305 E
MM	D <sub>max.</sub> <sup>(1)</sup>	23 (26) [0.906 (1.024)]	33.3 (36.3) [1.310 (1.430)]	33.3 (36.3) [1.310 (1.430)]	33.3 (36.3) [1.310 (1.430)]	33.3 (36.3) [1.310 (1.430)]	33.3 (36.3) [1.310 (1.430)]
	L ± 1.6 mm	101.6 [4.000]	101.6 [4.000]	152.4 [6.000]	203.2 [8.000]	266.7 [10.50]	304.8 [12.00]
	a	88.6 [3.490]	88.6 [3.490]	139.4 [5.490]	190.2 [7.490]	253.7 [9.990]	291.8 [11.49]
	a <sub>1</sub>	88.6 [3.490]	88.6 [3.490]	139.4 [5.490]	190.2 [7.490]	253.7 [9.990]	291.8 [11.49]
	b	8 [0.310]	8 [0.310]	8 [0.310]	8 [0.310]	8 [0.310]	8 [0.310]
	b <sub>1</sub>	5 [0.200]	8 [0.310]	8 [0.310]	8 [0.310]	8 [0.310]	8 [0.310]
	c	22 [0.870]	31 [1.220]	31 [1.220]	31 [1.220]	31 [1.220]	31 [1.220]
	c <sub>1</sub>	23 [0.910]	27 [1.060]	27 [1.060]	27 [1.060]	27 [1.060]	27 [1.060]
	d	12 [0.470]	18.5 [0.730]	18.5 [0.730]	18.5 [0.730]	18.5 [0.730]	18.5 [0.730]
	e	4.2 [0.170]	4.2 [0.170]	4.2 [0.170]	4.2 [0.170]	4.2 [0.170]	4.2 [0.170]
	e <sub>1</sub>	3.2 [0.130]	4.2 [0.170]	4.2 [0.170]	4.2 [0.170]	4.2 [0.170]	4.2 [0.170]
	s	0.8 [0.030]	0.8 [0.030]	0.8 [0.030]	0.8 [0.030]	0.8 [0.030]	0.8 [0.030]
	Weight (g)	62	136	200	260	330	430

**Notes**

<sup>(1)</sup> Numbers in (parenthesis) represent the Dimension D<sub>max.</sub> for resistor produced with corrugated ribbon.  
<sup>(2)</sup> Model according to MIL-R-26.

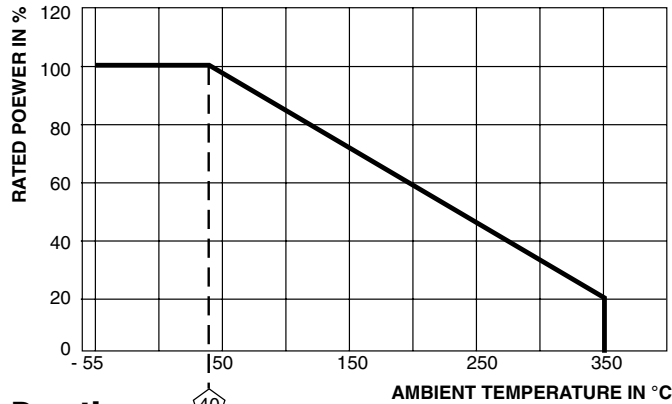

**Derating**

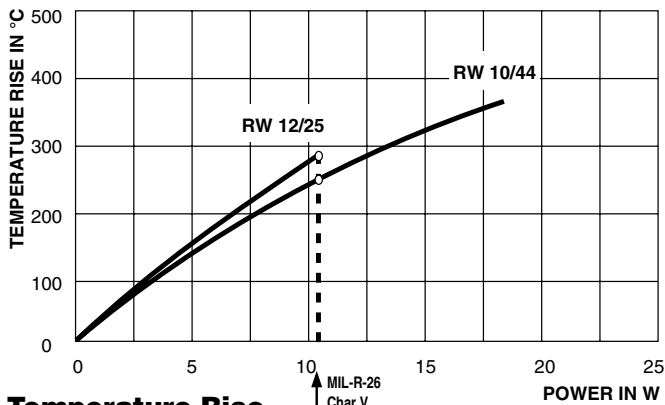

**Temperature Rise**

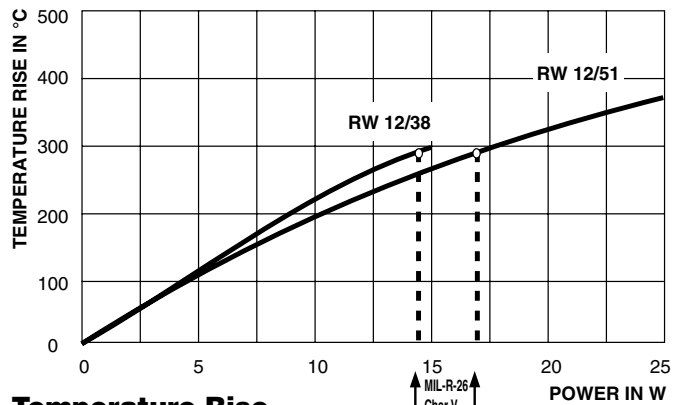

**Temperature Rise**

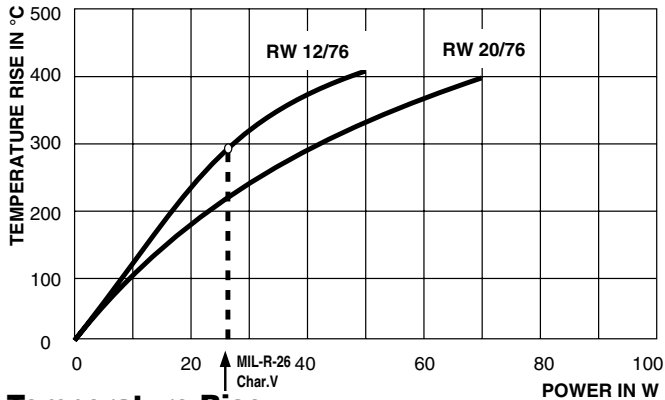

**Temperature Rise**

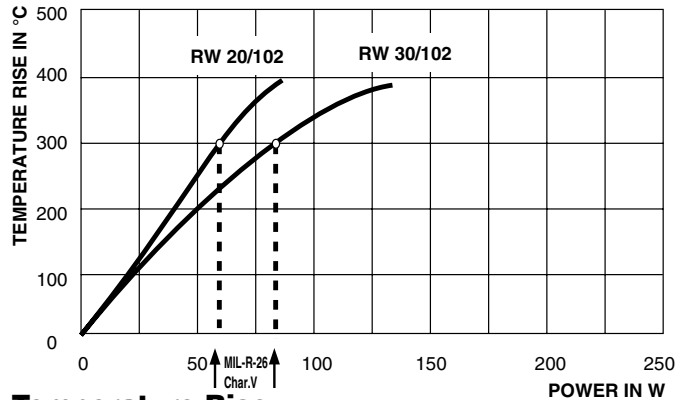

**Temperature Rise**

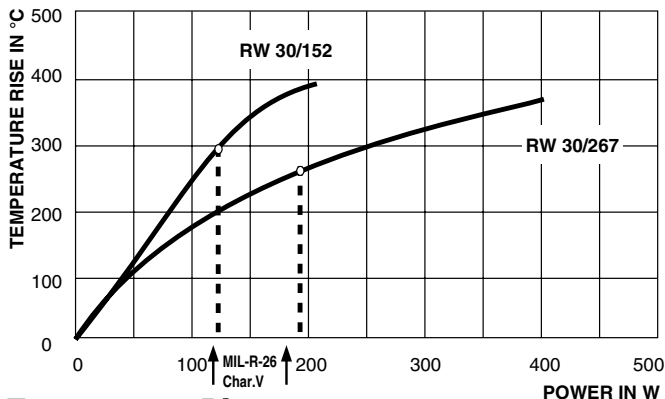

**Temperature Rise**

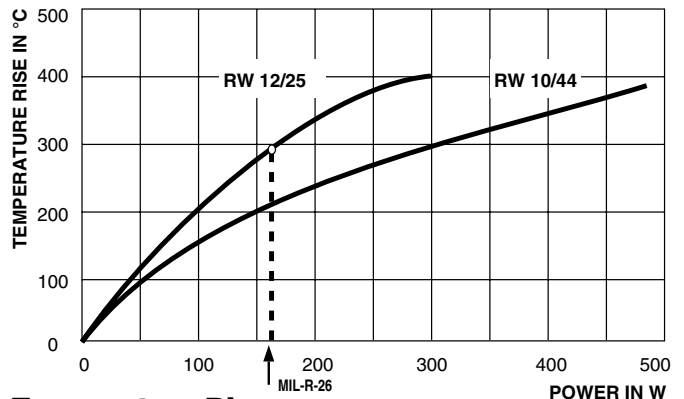

**Temperature Rise**



## Disclaimer

All product specifications and data are subject to change without notice.

Vishay Intertechnology, Inc., its affiliates, agents, and employees, and all persons acting on its or their behalf (collectively, "Vishay"), disclaim any and all liability for any errors, inaccuracies or incompleteness contained herein or in any other disclosure relating to any product.

Vishay disclaims any and all liability arising out of the use or application of any product described herein or of any information provided herein to the maximum extent permitted by law. The product specifications do not expand or otherwise modify Vishay's terms and conditions of purchase, including but not limited to the warranty expressed therein, which apply to these products.

No license, express or implied, by estoppel or otherwise, to any intellectual property rights is granted by this document or by any conduct of Vishay.

The products shown herein are not designed for use in medical, life-saving, or life-sustaining applications unless otherwise expressly indicated. Customers using or selling Vishay products not expressly indicated for use in such applications do so entirely at their own risk and agree to fully indemnify Vishay for any damages arising or resulting from such use or sale. Please contact authorized Vishay personnel to obtain written terms and conditions regarding products designed for such applications.

Product names and markings noted herein may be trademarks of their respective owners.