

## Small Signal Zener Diodes, Dual

### Features

- These diodes are available in other case styles and configurations including: the dual diode common anode configuration with type designation AZ23, the single diode SOT23 case with the type designation BZX84C-V, and the single diode SOD123 case with the type designation BZT52C-V.
- Dual Silicon Planar Zener Diodes, Common Cathode
- The Zener voltages are graded according to the international E 24 standard. Standard Zener voltage tolerance is  $\pm 5\%$ . Replace "C" with "B" for 2% tolerance.
- The parameters are valid for both diodes in one case.  $\Delta V_Z$  and  $\Delta r_{zj}$  of the two diodes in one case is  $\leq 5\%$
- Lead (Pb)-free component
- Component in accordance to RoHS 2002/95/EC and WEEE 2002/96/EC

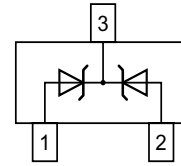
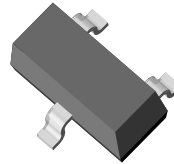

18110

### Mechanical Data

**Case:** SOT23 Plastic case

**Weight:** approx. 8.8 mg

**Packaging Codes/Options:**

GS18 / 10 k per 13" reel, (8 mm tape), 10 k/box

GS08 / 3 k per 7" reel, (8 mm tape), 15 k/box

### Absolute Maximum Ratings

$T_{amb} = 25\text{ }^\circ\text{C}$ , unless otherwise specified

Parameter	Test condition	Symbol	Value	Unit
Power dissipation		$P_{tot}$	300 <sup>1)</sup>	mW

<sup>1)</sup> Device on fiberglass substrate, see layout on page 7.

### Thermal Characteristics

$T_{amb} = 25\text{ }^\circ\text{C}$ , unless otherwise specified

Parameter	Test condition	Symbol	Value	Unit
Thermal resistance junction to ambient air		$R_{thJA}$	420 <sup>1)</sup>	K/W
Junction temperature		$T_j$	150	$^\circ\text{C}$
Storage temperature range		$T_{stg}$	- 65 to + 150	$^\circ\text{C}$

<sup>1)</sup> Device on fiberglass substrate, see layout on page 7.

### Electrical Characteristics

Partnumber	Marking Code	Zener Voltage Range <sup>1)</sup>		Dynamic Resistance		Test Current	Temperature Coefficient of Zener Voltage		Reverse Voltage		
		$V_Z$ at $I_Z$		$r_{zj}$ at $I_Z = 5 \text{ mA}$ , $f = 1 \text{ kHz}$ ,	$r_{zj}$ at $I_Z = 1 \text{ mA}$ , $f = 1 \text{ kHz}$ ,		$I_Z$	$\alpha_{VZ}$ at $I_Z = 5 \text{ mA}$		$V_R$ at $I_R = 100 \text{ nA}$	
		V		$\Omega$			mA	$10^{-4}/^\circ\text{C}$		V	
		min	max				min	max			
DZ23C2V7-V	V1	2.5	2.9	75 (< 83)	< 500	5	- 9	- 4	-		
DZ23C3V0-V	V2	2.8	3.2	80 (< 95)	< 500	5	- 9	- 3	-		
DZ23C3V3-V	V3	3.1	3.5	80 (< 95)	< 500	5	- 8	- 3	-		
DZ23C3V6-V	V4	3.4	3.8	80 (< 95)	< 500	5	- 8	- 3	-		
DZ23C3V9-V	V5	3.7	4.1	80 (< 95)	< 500	5	- 7	- 3	-		
DZ23C4V3-V	V6	4	4.6	80 (< 95)	< 500	5	- 6	- 1	-		
DZ23C4V7-V	V7	4.4	5	70 (< 78)	< 500	5	- 5	2	-		
DZ23C5V1-V	V8	4.8	5.4	30 (< 60)	< 480	5	- 3	4	> 0.8		
DZ23C5V6-V	V9	5.2	6	10 (< 40)	< 400	5	- 2	6	> 1		
DZ23C6V2-V	V10	5.8	6.6	4.8 (< 10)	< 200	5	- 1	7	> 2		
DZ23C6V8-V	V11	6.4	7.2	4.5 (< 8)	< 150	5	2	7	> 3		
DZ23C7V5-V	V12	7	7.9	4 (< 7)	< 50	5	- 3	7	> 5		
DZ23C8V2-V	V13	7.7	8.7	4.5 (< 7)	< 50	5	4	7	> 6		
DZ23C9V1-V	V14	8.5	9.6	4.8 (< 10)	< 50	5	5	8	> 7		
DZ23C10-V	V15	9.4	10.6	5.2 (< 15)	< 70	5	5	8	> 7.5		
DZ23C11-V	V16	10.4	11.6	6 (< 20)	< 70	5	5	9	> 8.5		
DZ23C12-V	V17	11.4	12.7	7 (< 20)	< 90	5	6	9	> 9		
DZ23C13-V	V18	12.4	14.1	9 (< 25)	< 110	5	7	9	> 10		
DZ23C15-V	V19	13.8	15.6	11 (< 30)	< 110	5	7	9	> 11		
DZ23C16-V	V20	15.3	17.1	13 (< 40)	< 170	5	8	9.5	> 12		
DZ23C18-V	V21	16.8	19.1	18 (< 50)	< 170	5	8	9.5	> 14		
DZ23C20-V	V22	18.8	21.2	20 (< 50)	< 220	5	8	10	> 15		
DZ23C22-V	V23	20.8	23.3	25 (< 55)	< 220	5	8	10	> 17		
DZ23C24-V	V24	22.8	25.6	28 (< 80)	< 220	5	8	10	> 18		
DZ23C27-V	V25	25.1	28.9	30 (< 80)	< 250	5	8	10	> 20		
DZ23C30-V	V26	28	32	35 (< 80)	< 250	5	8	10	> 22.5		
DZ23C33-V	V27	31	35	40 (< 80)	< 250	5	8	10	> 25		
DZ23C36-V	V28	34	38	40 (< 90)	< 250	5	8	10	> 27		
DZ23C39-V	V29	37	41	50 (< 90)	< 300	5	10	12	> 29		
DZ23C43-V	V30	40	46	60 (< 100)	< 700	5	10	12	> 32		
DZ23C47-V	V31	44	50	70 (< 100)	< 750	5	10	12	> 35		
DZ23C51-V	V32	48	54	70 (< 100)	< 750	5	10	12	> 38		

<sup>1)</sup> Tested with pulses  $t_p = 5 \text{ ms}$



## Electrical Characteristics

Partnumber	Marking Code	Zener Voltage Range <sup>1)</sup>		Dynamic Resistance		Test Current	Temperature Coefficient of Zener Voltage		Reverse Voltage		
		$V_Z$ at $I_Z$		$r_{zj}$ at $I_Z = 5 \text{ mA}$ , $f = 1 \text{ kHz}$ ,	$r_{zj}$ at $I_Z = 1 \text{ mA}$ , $f = 1 \text{ kHz}$ ,		$I_Z$	$\alpha_{VZ}$ at $I_Z = 5 \text{ mA}$		$V_R$ at $I_R = 100 \text{ nA}$	
		V		$\Omega$			mA	$10^{-4}/^\circ\text{C}$		V	
		min	max				min	max			
DZ23B2V7-V	V1	2.65	2.75	75 (< 83)	< 500	5	- 9	- 4	-		
DZ23B3V0-V	V2	2.94	3.06	80 (< 95)	< 500	5	- 9	- 3	-		
DZ23B3V3-V	V3	3.23	3.37	80 (< 95)	< 500	5	- 8	- 3	-		
DZ23B3V6-V	V4	3.53	3.67	80 (< 95)	< 500	5	- 8	- 3	-		
DZ23B3V9-V	V5	3.82	3.98	80 (< 95)	< 500	5	- 7	- 3	-		
DZ23B4V3-V	V6	4.21	4.39	80 (< 95)	< 500	5	- 6	- 1	-		
DZ23B4V7-V	V7	4.61	4.79	70 (< 78)	< 500	5	- 5	2	-		
DZ23B5V1-V	V8	5	5.2	30 (< 60)	< 480	5	- 3	4	> 0.8		
DZ23B5V6-V	V9	5.49	5.71	10 (< 40)	< 400	5	- 2	6	> 1		
DZ23B6V2-V	V10	6.08	6.32	4.8 (< 10)	< 200	5	- 1	7	> 2		
DZ23B6V8-V	V11	6.66	6.94	4.5 (< 8)	< 150	5	2	7	> 3		
DZ23B7V5-V	V12	7.35	7.65	4 (< 7)	< 50	5	- 3	7	> 5		
DZ23B8V2-V	V13	8.04	8.36	4.5 (< 7)	< 50	5	4	7	> 6		
DZ23B9V1-V	V14	8.92	9.28	4.8 (< 10)	< 50	5	5	8	> 7		
DZ23B10-V	V15	9.8	10.2	5.2 (< 15)	< 70	5	5	8	> 7.5		
DZ23B11-V	V16	10.8	11.2	6 (< 20)	< 70	5	5	9	> 8.5		
DZ23B12-V	V17	11.8	12.2	7 (< 20)	< 90	5	6	9	> 9		
DZ23B13-V	V18	12.7	13.3	9 (< 25)	< 110	5	7	9	> 10		
DZ23B15-V	V19	14.7	15.3	11 (< 30)	< 110	5	7	9	> 11		
DZ23B16-V	V20	15.7	16.3	13 (< 40)	< 170	5	8	0.5	> 12		
DZ23B18-V	V21	17.6	18.4	18 (< 50)	< 170	5	8	0.5	> 14		
DZ23B20-V	V22	19.6	20.4	20 (< 50)	< 220	5	8	10	> 15		
DZ23B22-V	V23	21.6	22.4	25 (< 55)	< 220	5	8	10	> 17		
DZ23B24-V	V24	23.5	24.5	28 (< 80)	< 220	5	8	10	> 18		
DZ23B27-V	V25	26.5	27.5	30 (< 80)	< 250	5	8	10	> 20		
DZ23B30-V	V26	29.4	30.6	35 (< 80)	< 250	5	8	10	> 22.5		
DZ23B33-V	V27	32.3	33.7	40 (< 80)	< 250	5	8	10	> 25		
DZ23B36-V	V28	35.3	36.7	40 (< 90)	< 250	5	8	10	> 27		
DZ23B39-V	V29	38.2	39.8	50 (< 90)	< 300	5	10	12	> 29		
DZ23B43-V	V30	42.1	43.9	60 (< 100)	< 700	5	10	12	> 32		
DZ23B47-V	V31	46.1	47.9	70 (< 100)	< 750	5	10	12	> 35		
DZ23B51-V	V32	50	52	70 (< 100)	< 750	5	10	12	> 38		

<sup>1)</sup> Tested with pulses  $t_p = 5 \text{ ms}$

## Typical Characteristics

$T_{amb} = 25\text{ }^{\circ}\text{C}$ , unless otherwise specified

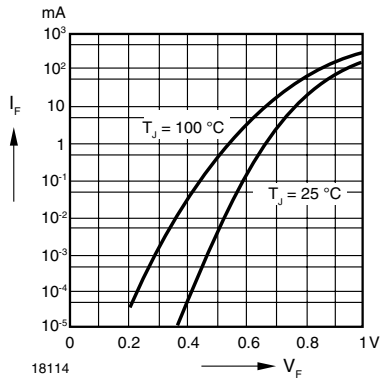

Figure 1. Forward characteristics

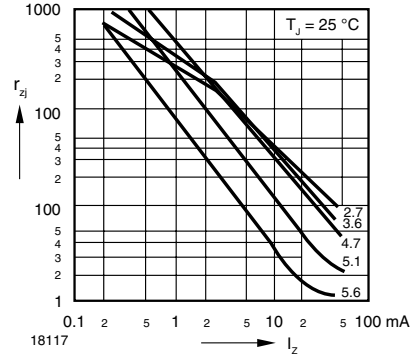

Figure 4. Dynamic Resistance vs. Zener Current

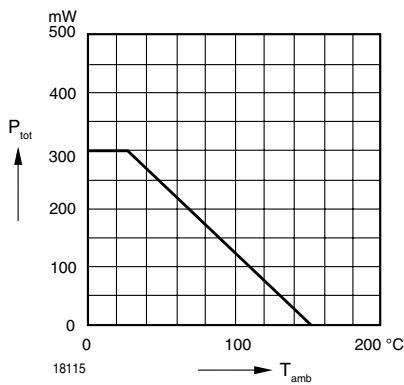

Figure 2. Admissible Power Dissipation vs. Ambient Temperature

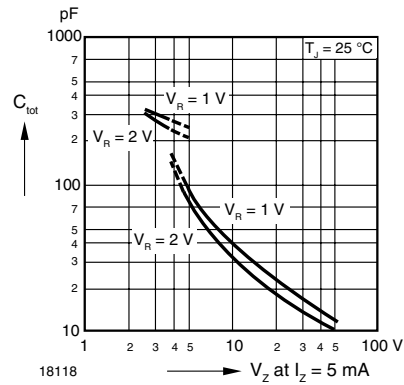

Figure 5. Capacitance vs. Zener Voltage

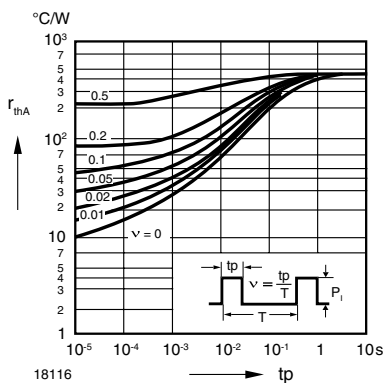

Figure 3. Pulse Thermal Resistance vs. Pulse Duration

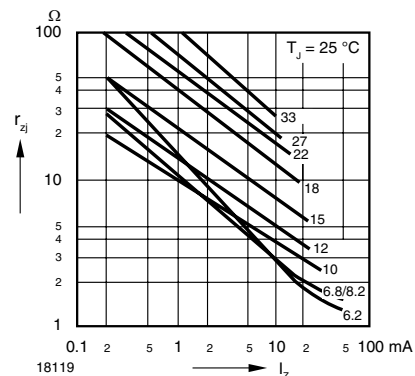

Figure 6. Dynamic Resistance vs. Zener Current

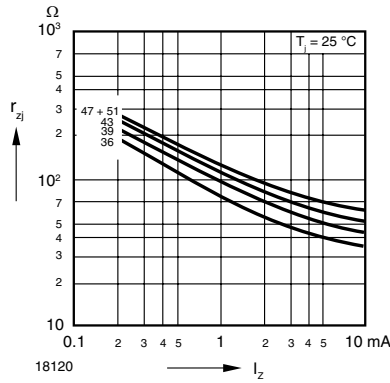

Figure 7. Dynamic Resistance vs. Zener Current

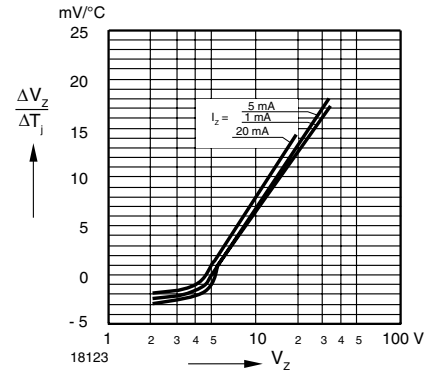

Figure 10. Temperature Dependence of Zener Voltage vs. Zener Voltage

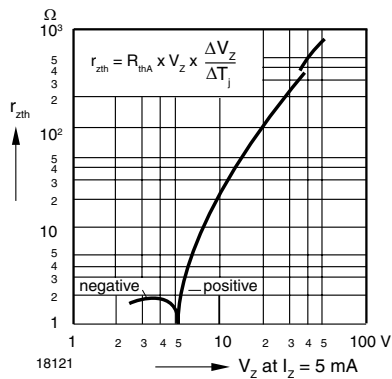

Figure 8. Thermal Differential Resistance vs. Zener Voltage

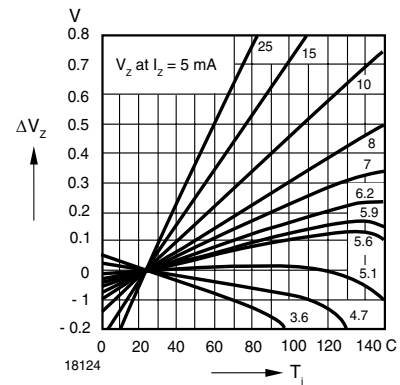

Figure 11. Change of Zener Voltage vs. Junction Temperature

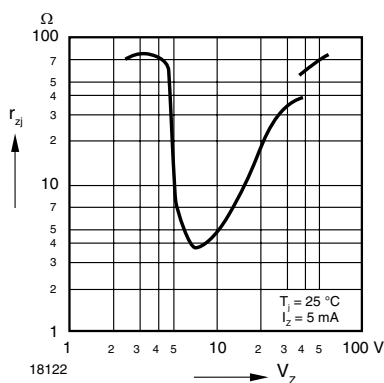

Figure 9. Dynamic Resistance vs. Zener Voltage

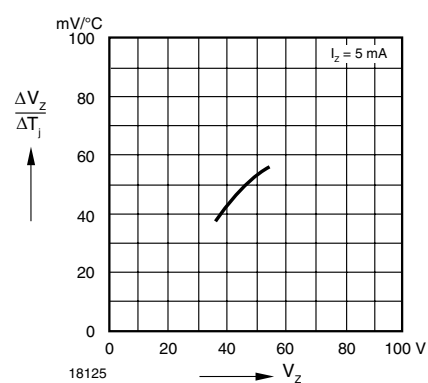

Figure 12. Temperature Dependence of Zener Voltage vs. Zener Voltage

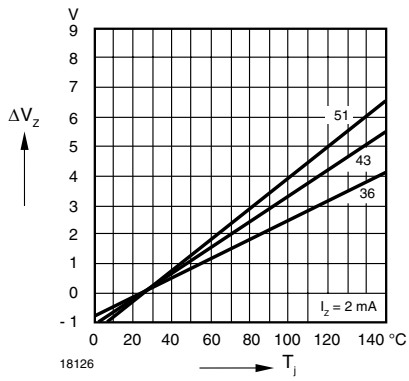

Figure 13. Change of Zener Voltage vs. Junction Temperature

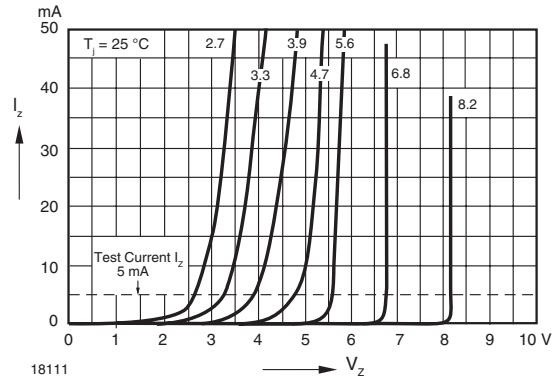

Figure 16. Breakdown Characteristics

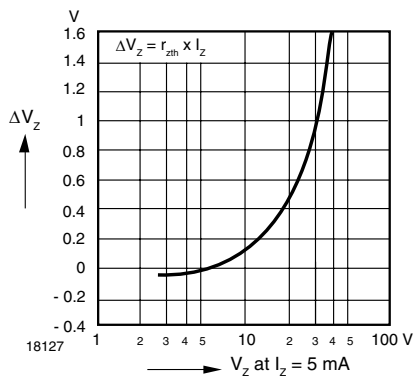

Figure 14. Change of Zener voltage from turn-on up to the point of thermal equilibrium vs. Zener voltage

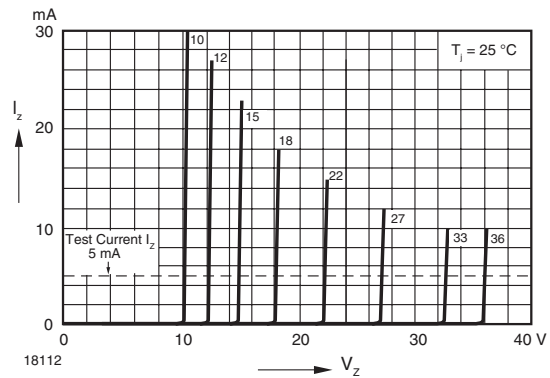

Figure 17. Breakdown Characteristics

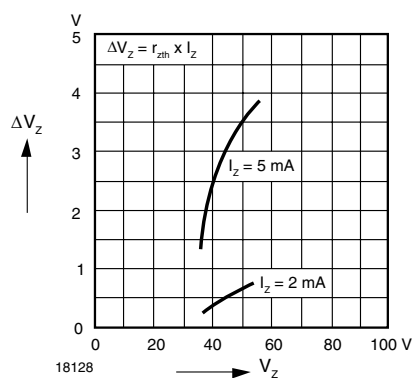

Figure 15. Change of Zener voltage from turn-on up to the point of thermal equilibrium vs. Zener voltage

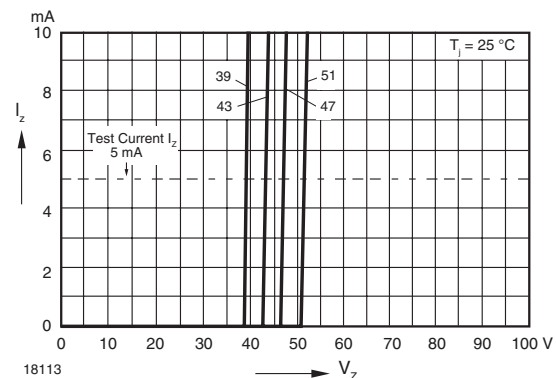
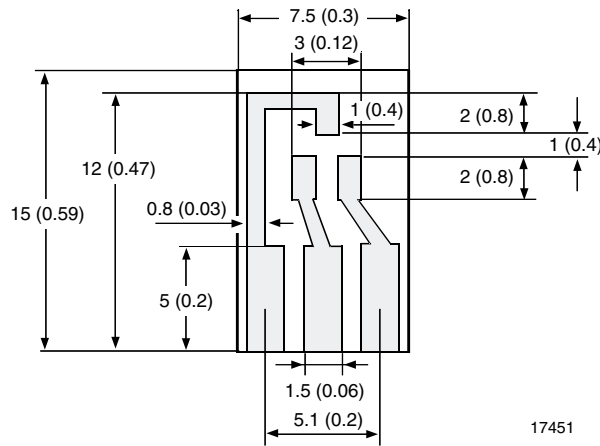

Figure 18. Breakdown Characteristics

## Layout for $R_{thJA}$ test

Thickness: Fiberglass 0.059 in. (1.5 mm)

Copper leads 0.012 in. (0.3 mm)



## Package Dimensions in mm (Inches)

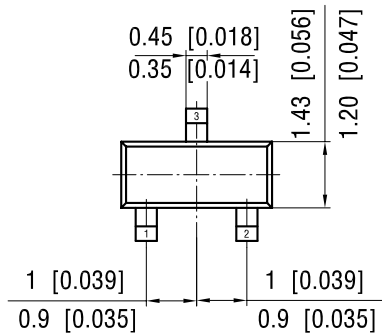
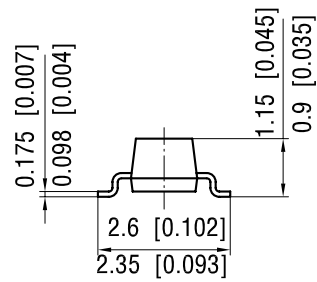
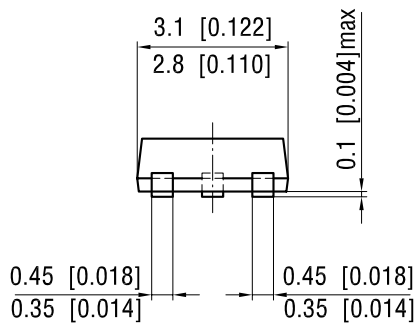

foot print recommendation:

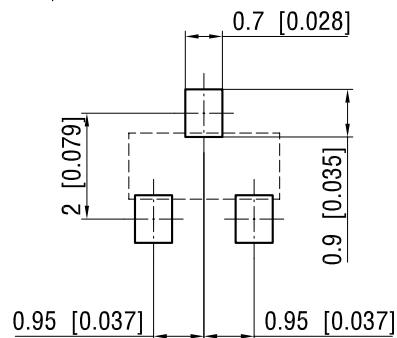

Document no.: 6.541-5014.01-4  
Rev. 6 - Date: 08.July.2004

17418

### Ozone Depleting Substances Policy Statement

It is the policy of Vishay Semiconductor GmbH to

1. Meet all present and future national and international statutory requirements.
2. Regularly and continuously improve the performance of our products, processes, distribution and operating systems with respect to their impact on the health and safety of our employees and the public, as well as their impact on the environment.

It is particular concern to control or eliminate releases of those substances into the atmosphere which are known as ozone depleting substances (ODSs).

The Montreal Protocol (1987) and its London Amendments (1990) intend to severely restrict the use of ODSs and forbid their use within the next ten years. Various national and international initiatives are pressing for an earlier ban on these substances.

Vishay Semiconductor GmbH has been able to use its policy of continuous improvements to eliminate the use of ODSs listed in the following documents.

1. Annex A, B and list of transitional substances of the Montreal Protocol and the London Amendments respectively
2. Class I and II ozone depleting substances in the Clean Air Act Amendments of 1990 by the Environmental Protection Agency (EPA) in the USA
3. Council Decision 88/540/EEC and 91/690/EEC Annex A, B and C (transitional substances) respectively.

Vishay Semiconductor GmbH can certify that our semiconductors are not manufactured with ozone depleting substances and do not contain such substances.

We reserve the right to make changes to improve technical design  
and may do so without further notice.

Parameters can vary in different applications. All operating parameters must be validated for each customer application by the customer. Should the buyer use Vishay Semiconductors products for any unintended or unauthorized application, the buyer shall indemnify Vishay Semiconductors against all claims, costs, damages, and expenses, arising out of, directly or indirectly, any claim of personal damage, injury or death associated with such unintended or unauthorized use.

Vishay Semiconductor GmbH, P.O.B. 3535, D-74025 Heilbronn, Germany





## Disclaimer

All product specifications and data are subject to change without notice.

Vishay Intertechnology, Inc., its affiliates, agents, and employees, and all persons acting on its or their behalf (collectively, "Vishay"), disclaim any and all liability for any errors, inaccuracies or incompleteness contained herein or in any other disclosure relating to any product.

Vishay disclaims any and all liability arising out of the use or application of any product described herein or of any information provided herein to the maximum extent permitted by law. The product specifications do not expand or otherwise modify Vishay's terms and conditions of purchase, including but not limited to the warranty expressed therein, which apply to these products.

No license, express or implied, by estoppel or otherwise, to any intellectual property rights is granted by this document or by any conduct of Vishay.

The products shown herein are not designed for use in medical, life-saving, or life-sustaining applications unless otherwise expressly indicated. Customers using or selling Vishay products not expressly indicated for use in such applications do so entirely at their own risk and agree to fully indemnify Vishay for any damages arising or resulting from such use or sale. Please contact authorized Vishay personnel to obtain written terms and conditions regarding products designed for such applications.

Product names and markings noted herein may be trademarks of their respective owners.